

Inside F83

Dr. C. H. Ting

Fourth Edition

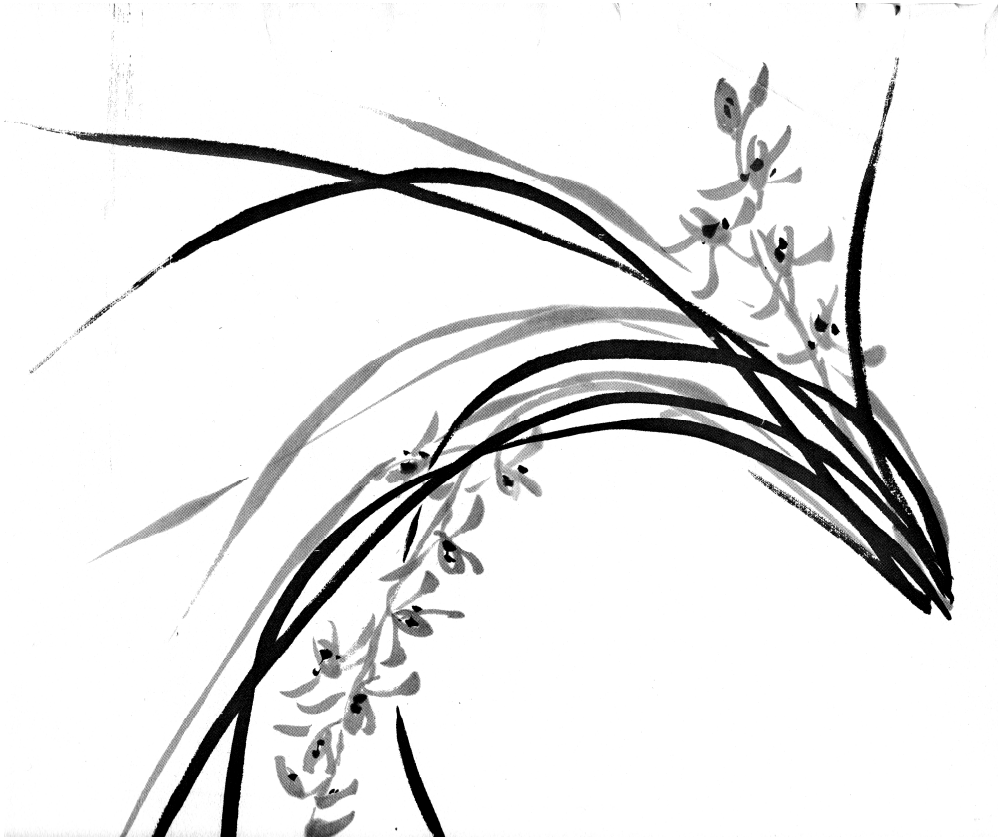

Offete Enterprises, Inc.

2013

(c) Copyright, 1991 by C. H. Ting

First Edition, November 1984

Second Edition, June 1985

Third Edition, June 1991

Fourth Edition, June 2013

**All rights reserved. This book, or any part thereof,
may not be reproduced in any form
without written permission from the author.**

Printed in the United States of America

by

Offete Enterprises, Inc.

**156 14 th Avenue
San Mateo, CA 94402
Tel: (415) 571-7639**

Preface to the Fourth Edition

It is thirty years since F83 was first released by Mike Perry and Henry Laxen. This book was out of print a long time ago. Yet, I still receive requests for the printed copies. The book was originally produce on a CP/M microcomputer, with a Diablo daisy wheel printer. All the text was preserved, but the figures and tables could not be reproduced. Earlier, I released an electronic edition with figures and tables scanned from the original book. It was embarrassing, because it exceeded the 25 MB limit for email delivery, due to the scanned images. I think it is probably time to do a better job, taking advantages of Microsoft Words with its fonts and formatting capabilities.

I am using the 12 point Times New Roman font for all narration, and the 8 point Courier New font for all source code and documentation. Code and documentation are presented in two columns. Left column is for code and right column for documentation. As the left column is generally 1.5 inches wide, I allow only 1 character space for each level of indentation. It is hard to see the nested levels, but I think is adequate if you do want to inspect the code in detail.

The only significant modification is on the term of ‘words’. In the original book, Forth commands were called Forth words, Forth definitions, and sometimes Forth commands. Now I have decided to call things which are executed by the host computer machine instructions or just instructions. What’s executed by the Virtual Forth Computer are commands, which are mostly colon commands and code commands. I think it is now very consistent in the narration. However, in the documentation, words and definitions are not changed.

Many figures were listings produced by an old IBM PC which was sent to dump yard long ago. I was extremely please that I could get the 8086 F83 v.2.10 to run in a small CMD window on my old desktop PC with Windows XP. The listings were produce by redirecting text output to a file. F83 is still alive! It reads and writes to a floppy disk in the A: drive. Boy! I am lucky that I keep this PC which still has a 3.5” floppy drive. I almost threw it away, as it developed some intermittent disk problems.

Seeing a working F83 system in front of me, it’s like seeing a good old friend coming back after 30 years. It makes me feel encourage, and gives me hope that this new edition of Inside F83 may still be useful for some friends out there. It will also save some trees.

C. H. Ting

July 2013
San Mateo, California

Preface to the Third Edition

It is almost eight years since F83 was first released by Mike Perry and Henry Laxen. It has been widely distributed by many shareware and freeware distributors, as well as through many bulletin boards. It also has found its way into many real applications and useful products. Although we have seen many better public domain Forth systems brought out over the years, F83 still stands out because of its high quality and because it is available on three very popular microprocessors: 8080, 8086, and 68000.

The quality of F83 is testified by the fact that over the years, we have found only one bug in the 8086 F83 system (DOS Version 2.10). This bug was discovered by Mike Yantis at Maxtor Corp. The ENTRY cell in the user area contains 90H (NOP) and E9H (JMP) when the task is asleep. E9H causes a jump to the next task, thus skipping the current task. These two bytes are changed to CDH and 80H (INT 80) when the task is to be waken. INT 80H wakes up this task when the CPU control is passed to the task. This scheme works fine in most instances. This mechanism falls apart only if the waking up routine is activated by an interrupt, and if the interrupt hits when the CPU just finishes executing the NOP (90H) instruction and is ready to execute the JMP (E9H) instruction. Unfortunately, the waking up routine secretly changed E9H to 80H, whose behavior at this point is unpredictable and in most cases crashed the CPU. The probability of this occurring is very small, only about once in 100,000 interrupts, which were enough to bother Mike Yantis. Mike fixed this bug by choosing INT E9H to start the wakened tasks.

Discussing this bug in detail is meant to be a compliment to Mike Perry and Henry Laxen in their efforts producing the F83 system. It took a bug of such a oblique nature to escape Mike and Henry's tight grips.

I take this opportunity to revise the book and produce it using a laser printer. I am always amazed at how a laser printer can transform lies into truth. In spite of the laser, I like to give special thanks to Jay McKnight in reviewing the text and corrected many of my grammatical and technical errors.

F83 is one among the very few Forth systems which are useful while still understandable. Inside F83 had helped many people gain the privilege to peek inside a fully functional Forth system. I hope it will help you also. Not just take a peek, but use it as a key and open a whole new field to yourself.

C. H. Ting

June 1991
San Mateo, California

Preface to the Second Edition

After I implemented my first Forth system on a Data General Nova computer and got the 'OK' message, I went back home and told my wife: "I just promoted myself from an applications programmer to a system programmer!" I was so excited and my brain was so completely filled with the intricate details of the Forth fabric that the only way to get hold of myself was to dump everything on paper. That was the Systems Guide to figForth. I xeroxed it and brought a boxful to the then Northern California FIG meeting and it was sold out immediately. Apparently I had struck a chord in the Forth community which was desperately in need of documentation and instruction on Forth internals.

I was fortunate that a polyForth on LSI-11 computer was available at work. I tried to convince Forth, Inc. to publish a similar book on polyForth and obtained some support to proceed. I sent a draft manual, titled Systems Guide to polyForth to Forth, Inc. Somehow, Forth, Inc. decided not to publish or promote it, and had left it on their bookshelf. I heard that it found its way into the underground Forth circle in Southern California. PolyForth is concise and powerful, and it deserves better system documentation than what is provided. I was very impressed as I went through it screen by screen. I was delighted in picking a great mind, that of Chuck Moore himself. It was like poetry.

When Mike Perry and Henry Laxen released their public domain F83 system, I bought a listing to read. It was a very worthy product, with lots of tools and utilities. The best part is that it is complete with on-line documentation in the form of shadow screens. I thought there was little for me to contribute. As F83 was spreading wider, we started to hear more complaints about the difficulties in learning and using it. I reached a conclusion that Forth screens are good medium for programming, but a screen is too small a window for viewing and learning a large Forth system, even with shadows. In reading the source code, it is necessary to look at many screens at the same time, quickly moving from one screen to another while keeping everything in plain view. We have all been conditioned to read things in the printed form, making the best use of our visual system with instant zooming and panning capability. The visual system is very difficult to emulate with a 24 by 80 character screen.

Then Wil Baden came to one of the FIG meetings and showed the completely sorted index of F83 words in all vocabularies. I rushed to the front table and grabbed a copy of his handout with the index, which was the tool I needed to navigate through the F83 system. With the help of the index, lots of midnight oil, and ignoring my wife's orders to clean up my room, I was able to rearrange the source code of F83 in a form more tangible to mortal souls. Most of the work was simply rearranging the source code from the horizontal to the vertical format and fill the right hand side of the page with words taken from the shadow screens. I collected related source code and present it in a logical sequence, which often does not coincide with the loading sequence of the source screens. Once the code is ordered logically, you will find it is much easier to comprehend this very large and seemingly intimidating system.

F83 provides a very extensive and solid foundation for professional programmers to build application packages. It is also a very useful source for beginners to learn Forth programming style and techniques. Its problem, as in any large Forth system, is the fragmentation of functions

in a multitude of words. With more than 1000 words, it is very difficult to have a firm handle on F83. However, functions a user needs to program a computer application or to use a computer application are not that many. Once you are familiar with those top level utility words, you can dig into the underlying low level words and use them to build your own castles. This book, I hope, will serve the purpose of showing you the power and the beauty behind the Forth language.

We are all indebted to Mike Perry and Henry Laxen for releasing the F83 system into the public domain. It certainly sets a higher standard for commercial Forth systems and forces Forth vendors to provide more powerful systems and better user support. Anything less than F83 will not be acceptable anymore. Thanks are also due to Dr. S. Y. Tang and Mr. John Peters for reading the manuscript and making numerous suggestions and corrections. The Chinese brush painting on the covers was provided by my mother, Mrs. I-Jean Hwang Ting. My father, Mr. C. W. Ting, was the editor and also managed the production of this book. This is a traditional Chinese family business, small but efficient and very Forth-like.

C. H. Ting

May 1985
San Mateo, California

INSIDE F83

Contents

Part I	Introduction to F83 system	
1	The heritage of F83	
1.1	The roots of the F83	1
1.2	Advancements in Forth-83 Standard	3
1.3	Creators of F83 system	4
1.4	Features of F83 system	6
2.	Browsing F83 system	8
2.1	Listing the word names	9
2.2	Vocabulary	10
2.3	Viewing source code of word definitions	13
2.4	Shadow screen documentation	15
2.5	Files in F83	16
2.6	Printing utility	17
2.7	Debugger	19
3.	Using the F83 system	21
3.1	Create your own file	21
3.2	The editor	23
3.3	Loading and testing your program	25
3.4	Memory dump	26
3.5	Debugging your program	28
3.6	The 8086 assembler	29
3.7	Multitasker	33
3.8	Save a system image	34
3.9	The meta-compiler	35
Part II	The Forth kernel	
4.	Interface to the host computer	37
4.1	Virtual Forth computer	37
4.2	Forth computer hosted on 8086	38
4.3	Inner interpreters	41
4.4	Interpreters for in-line data and strings	46
4.5	Interpreters for control structures	48
5.	The Forth nucleus	51
5.1	8086 assembly language in Forth	51
5.2	Code definitions in Forth nucleus	52
5.3	Examples of code definitions	53
6.	Terminal input and output	56
6.1	The BDOS I/O calls to the operating system	56
6.2	Terminal output commands	57
6.3	Interpreting control characters	57
6.4	More sophisticated input commands	58
6.5	String commands	60
7.	The virtual memory	62

7.1	Mass storage and virtual memory	62
7.2	Disk buffers	63
7.3	The file control block (FCB)	65
7.4	Read and write disk files	66
7.5	Disk buffer management	67
7.6	Saving disk buffers to disk files	71
8.	Dictionary and vocabulary	73
8.1	Threading of the dictionary	73
8.2	Hashing and searching the dictionary	75
9.	Number input and output	81
9.1	Representation of numeric data	81
9.2	Input number conversion	82
9.3	Output number conversion	85
9.4	Double integer output	86
10	Word parsing	88
10.1	Text processing	88
10.2	Input stream and input buffers	88
10.3	Low level parsing commands	89
10.4	High level parsing commands	91
10.5	String commands defined using PARSE	92
10.6	End-of-buffer condition	92
11.	Text interpreter	94
11.1	The operating system of Forth	94
11.2	Entering the text interpreter	94
11.3	INTERPRET	95
11.4	DONE? and X	96
12.	Compiler	98
12.1	The colon definition	98
12.2	Colon and semicolon	99
12.3	The compiler loop	100
12.4	Low level supporting commands	102
12.5	Immediate commands	102
13.	Structures in colon definitions	105
13.1	Compiler directives	105
13.2	Compiling numeric data structures	106
13.3	Compiling string literals	107
13.4	Compiling control structures	109
13.5	Address calculation for control structures	112
13.6	Control structure compiler directives	112
Part III	Utilities in F83 system	
14.	The CP/M-DOS files	115
14.1	CP/M-DOS file primitive commands	115
14.2	The file control block	116
14.3	High level file commands	117
14.4	Save core image to a file	118
14.5	Directory accessing	118
14.6	System level file commands	119

15.		Text editors	121
	15.1	String utility	121
	15.2	Terminal dependent deferred words	123
	15.3	The cursor commands	123
	15.4	Editing buffers	125
	15.5	Line editing commands	127
	15.6	String editor commands	128
	15.7	Screen editor	120
	15.8	The screen display commands	131
	15.9	The screen editor commands	133
	15.10	Configuring the terminal	124
16.		Viewing source screens	136
	16.1	The view field	136
	16.2	The view files	137
	16.3	The viewing command	138
17.		WORDS	140
	17.1	Output formatting commands	140
	17.2	WORDS	140
18.		Disk file utility	142
	18.1	Displaying screens in a file	142
	18.2	Disk buffers	143
	18.3	Single block copying	144
	18.4	Multiple block copying	144
	18.5	Multiple file copying	145
19.		Memory dump	147
	19.1	The dumb DUMP	147
	19.2	The smart DUMP	147
20.		Decompiler	149
	20.1	Positional case defining word	149
	20.2	Associative defining word	150
	20.3	Decoding different classes of words	151
	20.4	Sorting and execution tables	152
	20.5	Decompiling different word classes	153
	20.6	Word classification	154
	20.7	The decompiler SEE	155
21.		Printing utility	157
	21.1	Variables and setup	157
	21.2	Printing two screens side by side	158
	21.3	Printing 6 screens on a page	159
	21.4	SHOW	161
Part IV		8086 Specific utilities	
22.		Debugger	163
	22.1	Low level supporting words	163
	22.2	High level trace commands	164
23.		Multitasker	166
	23.1	Multitasking	166

23.2	User variables and the user area	166
23.3	PAUSE and RESTART	168
23.4	The multitasker	170
23.5	Task definition	170
23.6	Background tasks	171
24.	8086 Assembler	173
24.1	Assembly tools	173
24.2	8086 register definitions	174
24.3	Addressing mode operators	176
24.4	Defining words to generate opcodes	180
24.5	Special opcodes	183
24.6	Structures in code definitions	185
25.	Metacompiler	188
25.1	Concept of metacompilation	188
25.2	Vocabularies for metacompilation	189
25.3	Accessing memory in the target system	191
25.4	Branching constructs	192
25.5	Forward referencing	194
25.6	Compiling new words to target system	195
25.7	Transition compiler directives	196
25.8	Defining words in metacompiler	198
25.9	User variables	199
25.10	Vocabulary	199
25.11	Resolving forward references	200
25.12	Redefining host words	201
25.13	Running the metacompiler	201
Index		204

Figures

1.1	The Forth family tree	2
1.2	The standard bearer	5
2.1	IBM-DOS files in F83 system	8
2.2	Forth commands	11
2.3	Assembler and DOS commands	11
2.4	Commands in other vocabularies	12
2.5	VIEW and SEE	15
2.6	File and directory commands	18
2.7	Debugging LIST	20
3.1	Memory dump	27
4.1	The virtual Forth computer	29
4.2	Memory map of F83 system	42
6.1	Representation of strings	61
7.1	The file control block	64
7.2	Disk buffer management	68
8.1	Structure of a Forth command	75
8.2	Vocabularies and dictionary structure	77
8.3	Four-way threading in a vocabulary	80
9.1	Input and output number conversion	83
10.1	Parsing with WORD	91
12.1	The interpreter and the compiler	101
13.1	Numeric data structures	107
13.2	The string literals	108
13.3	The control structures	111
15.1	The editing buffers	126
15.2	Screen editor display	131
16.1	The view field and the view files	137
20.1	Decoding different types of commands	152
20.2	Decompile different commands	156
21.1	Two printing formats	160
23.1	The round robin task scheduler	169
24.1	Register addressing mode constants	175
24.2	8086 instruction types	179
25.1	The chicken-egg cycle of meta-Forth	285
25.2	Supporting vocabularies for metacompilation	191

Tables

2.1	Vocabularies in F83	10
3.1	Editor commands	23
3.2	Loading commands	26
3.3	8086 registers and Forth registers	30
3.4	Register addressing modes and mnemonics	30
3.5	8086 assembler commands, Forth style	31
3.6	Return commands	31
3.7	Machine code conditionals	32
4.1	8086 Register assignments for Forth	39
6.1	String commands	60
9.1	Data representation	81
23.1	User variables	167

Part I. Introduction to F83 System

Chapter 1. The Heritage of F83

1.1. The Root of F83

Forth was invented by Charles Moore in the 60's as he developed specialized programming tools for various software projects and crystallized them into a language-operating system. Forth spread to many continents following the radio telescopes originally programmed by Mr. Moore when he was with the National Radio Astronomy Observatory. Forth was so prevalent in the astronomy communities that the International Astronomic Union formally adopted Forth as their standard programming language in 1974.

Mr. Moore and some of his colleagues left NRAO and formed the Forth, Inc. to market Forth systems and services in 1972. Over the years, a series of Forth implementations were produced for commercial minicomputers and microcomputers. These products evolved into poly-Forth, which contained many advanced features such as interrupt drive I/O, multitasking-multiprogramming, data base management, transcendental functions, and meta- or target compilation. It remains the most comprehensive Forth system in the Forth market place.

Forth users in Europe organized a user's group, called EuropeanForth users Group (EFUG). To encourage the exchange of Forth programs and information, EFUG published a list of Forth commands with standard commands, commonly known as the Forth-77 Standard. It documented the then often used Forth commands in an effort to prevent these commands from mutation as more Forth systems were installed.

The Forth Interest Group was organized in 1978 to encourage the use of Forth on small personal computers. Two major activities sponsored by FIG in 1978 were the publication of figForth Model and the organizing of the Forth Standards Team. Because of the low costs of the figForth source listings and the quality of these figForth implementations, figForth became the de facto standard of Forth on small computers. The product from the Forth Standards Team, the Forth-78 Standard, however, was not as successful. It was soon orphaned by FIG. The Forth Standards Team went back to the drawing board and produced the Forth-79 Standard which was much more

precise in wording and consistent in the naming of standard commands. Many vendors including Forth, Inc. made genuine efforts to adopt this standard into their products.

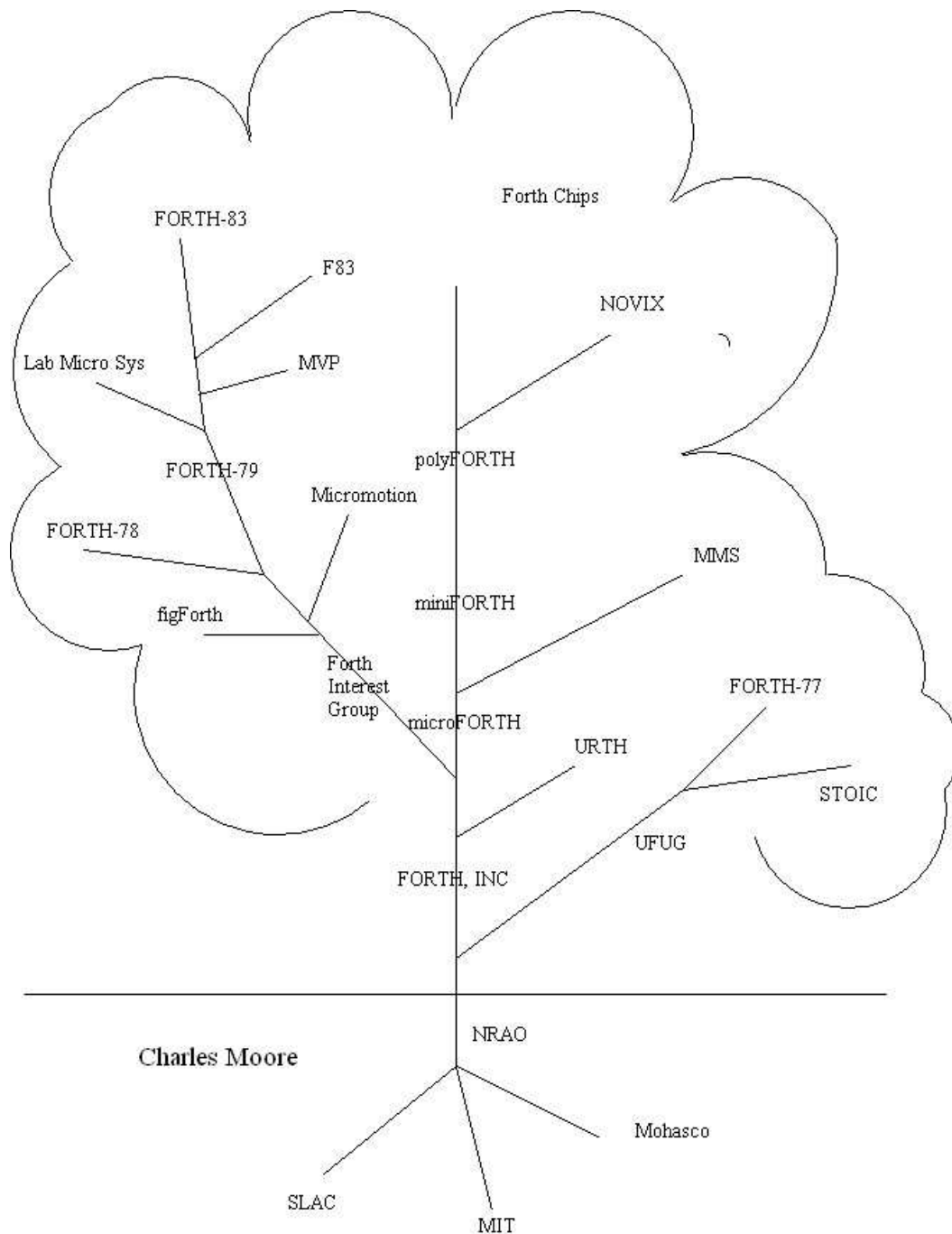

Figure 1.1 The Forth family tree

Several problems kept the Forth Standards Team working. Among them, the more serious ones are the state dependence of many commands, the loop structure, the representation of falsehood, integer division with negative divisor, and the naming of many commands. These problems were

resolved in the publication of the Forth-83 Standard in early 1984. The exhausted Forth Standards Team decided that no new Forth standard will be considered in the near future to let Forth-83 Standard some time to establish itself in the Forth community.

1.2. Advancements in Forth-83 Standards

Major improvements in Forth-83 Standards over previous Forth standards are briefly discussed here. Exhaustive discussions have appeared in Forth Dimensions, authored by the Secretary of the Forth Standards Team, Dr. Robert L. Smith. Some of the more significant features in the Forth-83 Standard are summarized here.

Mono-Addressing

Four addresses are used to address different fields in a command in the dictionary, the name field address, the link field address, the code field address, and the parameter field address. To allow maximum implementation flexibility and code portability, the 83-Standard uses only one address, the compilation address. It is equivalent to the code field address in the figForth model. The compilation address is the one returned by ' and FIND, compiled to colon commands, and used by EXECUTE to run the command. Only one extra command is provided in the standard to access information stored in the parameter field: >BODY.

The importance of the compilation address cannot be overstressed. Mono-addressing recognized this characteristics of Forth. It is also beneficial that the compilation address serves as the focal point in locating information stored in the commands.

Eliminating State Smart Commands

Many Forth commands in the early standards execute differently depending upon whether the system is in the execution mode or compiling mode, like LITERAL, ' (tick), ." , etc. In Forth-83 the state smart commands are either eliminated or separate commands are defined for interpreting and compiling states, making the system less ambiguous and faster.

Old ' is split into two commands: ' and []. Old ." is split into .(and ." .

Improved DO-Loop

The DO-LOOP structure went through a major overhaul in Forth-83. The range of index is extended to 64K so that full memory range can be addressed in the loops.

LEAVE is made to terminate the loop immediate upon its execution rather than wait until LOOP is executed.

Improved Division

Division is now floored towards negative infinity instead of rounded towards zero. It is more useful in that the quotient and modulus have a smooth change between positive integer and negative integer domain when either divisor and/or dividend is negative.

Representation of True Flag

A true flag generated by the Forth-83 system is represented by -1 instead of 1 in the older standards. -1 is more useful than 1 in doing bit-wise logic operation.

Consequently, NOT can now be defined as one's complement operation instead of being simply an alias of 0=.

Zero-based PICK and ROLL

Top of the data stack is treated as the based of a memory area and addressing into this area is zero based like addressing regular memory areas.

WORD Returning an Address

Word buffer was generally assumed to be at the top of the dictionary. However, this is implementation dependent. With WORD returning the address of the word buffer, the word buffer can be assigned to other memory areas. Practical usage of WORD always requires the address of the WORD buffer. Including the word buffer address in the WORD function is a convenience to you. A slight speed advantage can also be realized.

1.3. Creators of the F83 Systems

F83 is a very extensive language and operating system created by Henry Laxen and Mike Perry, two professional Forth programmers in Berkeley, California. Both of them have been active in the Forth Interest Group since its beginning, and participated in the work of the Forth Standard Team to develop Forth-79 Standard and Forth-83 Standard. They have published papers and written tutorials on Forth in Forth Dimensions and in the FORML (Forth Modification Laboratory) proceedings. As Forth-83 Standard evolved, they felt the need of a complete Forth system based on this standard to carry the standard to Forth users and community, in the same way the figForth implementations on the 6 popular microprocessors carried the figForth model. F83 system was the result of their efforts.

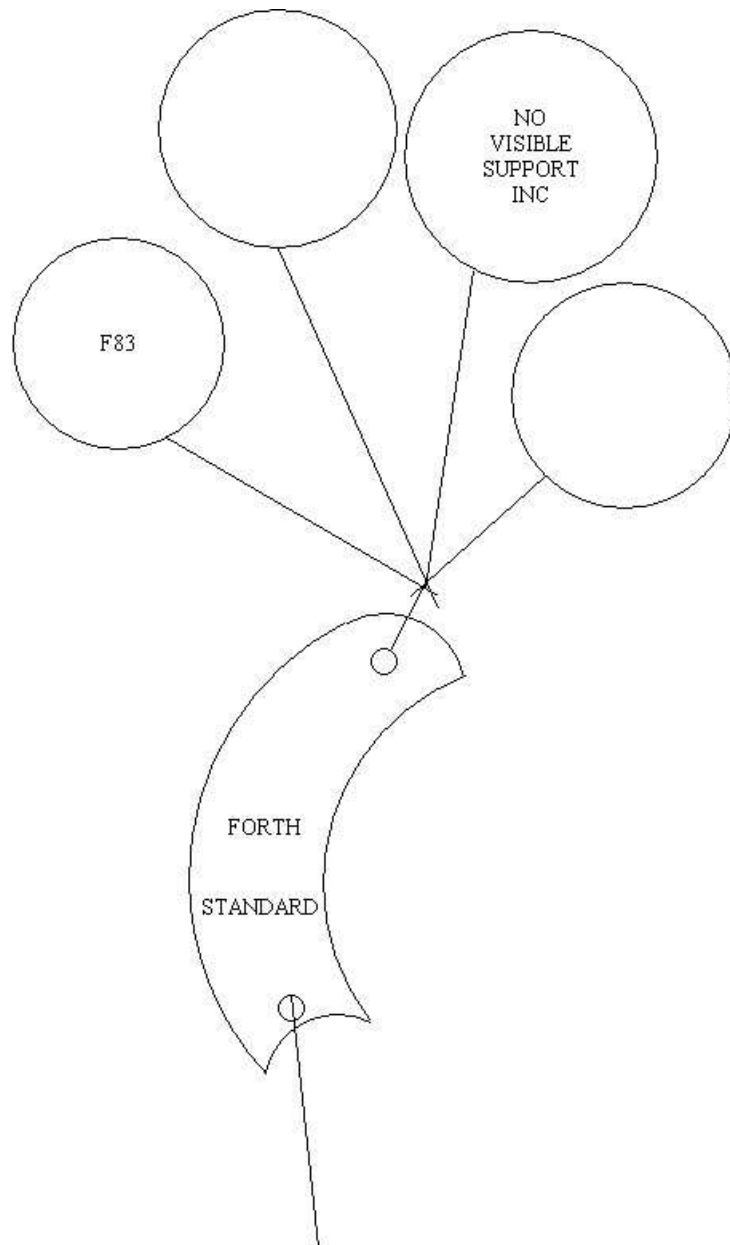

Figure 1.2. The Standard Bearer

The F83 system was designed to use the CP/M operating system as its host for terminal input-output and disk interface so it is rather straightforward to be transported to a variety of microcomputers using the CP/M system. It has been implemented for 8080-Z80, 8086-8088, and 68000 CPU's. Laxen and Perry put this system in the public domain, according to the tradition of the Forth Interest Group, as a vehicle to distribute the newly established Forth-83 Standard. Wil Baden at Los Angeles ported it to the Apple II computer and named his system F83X.

F83 Version 1.0 was released by Perry and Laxen in September, 1983, shortly after the Forth-83 Standard was published. They also organized an F83 working group in the Northern California to evaluate the F83 system for practical applications. The F83 system, over the period of about a

year, was enhanced and upgraded several times. The latest version, Version 2.1 was released in the summer of 1984. The authors promised that this version will not be modified in the near future, and it should be stable for you to get familiar with it and to be distributed to a wider audience.

This book is meant to be a reference manual to the F83 system. It was originally written for the F83 system Version 1.0 for the 8086 processor on a CP/M86 operating system. Since the release of Version 2.1, it was also upgraded to this version. Due to the overwhelming spread of the IBM Personal Computers and its compatible models, it was also modified for using with the F83 system for the MS-DOS system. As for the other F83 systems, it is useful as a reference for all the high level Forth commands. For low level machine code commands, you will have to refer to the source code and documentation coming with the specific F83 system.

1.4. Features of F83 System

F83 is not a toy language like most other public domain and some commercial Forth system. It contains all the necessary utilities and tools for you to develop application programs conveniently and efficiently. Both executable object codes and the source codes are provided and distributed on floppy diskettes in the machine readable form. Although Laxen and Perry do not intend to provide support and consultation on the F83 system, as they called their publishing firm No Visible Support, Inc., the systems they distributed are of excellent quality and can stand on their own strength. Extensive documentation are provided in the form of shadow screens and in-line comments.

Laxen and Perry intended that F83 should demonstrate and bring out the best features in Forth as a professional programming language. Many utilities and tools were included in this system which are not generally available even in the best of the commercial Forth systems. Some of these utilities are listed here:

- Editor
- Assembler for the host CPU
- Full BIOS/BDOS interface
- Multiple file accessing
- Four-way threaded dictionary
- Dynamically defined vocabulary search order
- Source code viewing
- Decompiler
- Debugger
- Memory dumping
- Multitasking
- Shadow-screen documentation
- Source and documentation printing
- Forward referencing
- Metacompiler
- Huffman code compression and expansion

In realizing all these functions, F83 has more than 1000 commands in its dictionary, comparing with about 300 commands in the figForth model and 130 commands in the required command set of Forth 83-Standard. Casual users may not need to know the details of all these commands. However, this whole F83 system is a huge reservoir of Forth programming examples from which serious Forth programmers can study and find ready solutions to many of their programming problems.

FigForth became the de facto standard of Forth on small computer systems because of the quality and the availability of the source listings distributed by the Forth Interest Group. The figForth system is complete in the sense that it includes all the necessary system functions so that it can be implemented on real life microprocessors. The Forth 79-Standard, on the other hand, had not attained the popularity of figForth in spite of the intensive lobbying efforts within and without the Forth Interest Group. The principal reason is that 79-Standard has to be supported by a system to be useful. Forth Interest Group expected that the support to Forth 79-Standard would come from vendors of commercial Forth systems, and it did not provide executable systems in supporting the standard.

Forth-83 Standard is a refinement on the 79-Standard. Many ambiguities in the 79-Standard were resolved and all required commands are defined in better precision. The DO-LOOP structure was overhauled. However, Forth Interest Group maintained the policy to let Forth vendors to provide the system support to the 83-Standard. Because of the reservation they had in the capability of vendor supports, Laxen and Perry built the F83 system as the bearer of the 83-Standard. They also realized that the Forth community has matured over the years and a minimal system like figForth will not satisfy the needs of Forth users in building applications and systems. To be the standard bearer, F83 had to go beyond the figForth model and provides you with a complete program developing environment.

Chapter 2. Browsing F83 System

I assume that you have either followed the instructions as described in the README.TXT file on the original disk you obtained from Henry Laxen or Mike Perry and expanded the compressed files to the full length files comprising the F83 system, or somebody did the expansion for you and you have a set of floppy disks ready to be used to explore this interesting and powerful Forth operating system and language. If you did not have an expanded system, please read the instructions in the README file and then run the executable file RUNME. You will be guided step by step to create a set of disks which will contain all the files to be used by the F83 system, as show in Figure 2.1.

```
Volume in drive A has no label.
Volume Serial Number is 0000-0000

Directory of A:\

02/09/1985  09:23 PM           12,288  CLOCK.BLK
02/09/1985  09:23 PM           53,248  CPU8086.BLK
02/09/1985  09:23 PM           30,720  EXTEND86.BLK
02/09/1985  09:23 PM           26,368  F83.COM
02/09/1985  09:23 PM            4,993  F83-FIXS.TXT
02/09/1985  09:23 PM           43,008  HUFFMAN.BLK
02/09/1985  09:23 PM          190,592  KERNEL86.BLK
02/09/1985  09:23 PM           49,280  META86.BLK
02/09/1985  09:23 PM          112,640  UTILITY.BLK
06/24/2013  05:55 PM              0  2-2.TXT
             10 File(s)          523,137 bytes
             0 Dir(s)          916,480 bytes free
```

Figure 2.1. IBM PC-DOS files in F83 system

In this chapter, I would like to show you what are contained in the F83 system and also the files on the disks and help you to get familiar with this system. All the commands and exercises mentioned in this chapter can be used freely to exercise the system so that you will gain certain degree of confidence to use them later when you will do programming. These commands will in no way disturb the information stored on the disks. The best way to learn them is to type them in on the keyboard and observe the results on the CRT terminal.

F83 system is very large comparing to earlier public domain Forth system like figForth . It has about 1000 commands or commands in its dictionary. However, most commands are defined to support other high level commands and are seldom used for ordinary programming purposes. Only a very limited number of commands are used often and these are commands that a user must learn and be fluent in them to use Forth productively. Included in this set of commands are the required command set defined in the Forth-83 Standards, which is a minimum set of commands allowing you to compose solutions to a wide range of programming problems, and the set of utility commands in this F83 system which allows you to use the specific resources provided by your computer. I further assume that you have already had some knowledge on Forth by reading some

textbook like Leo Brodie's 'Starting Forth', or its equivalent, and used a Forth system from some other source. Therefore, I will not try to explain in details the elementary functions and commands common to most Forth system and only discuss those commands unique in the F83 system. The purpose is to get you to know this system well enough so that you will be able to use it as a basis to build your application or your new Forth system.

In this chapter, all the words or commands discussed are non-destructive. They will allow you to browse through the entire system and explore its riches without writing anything to any of the files. You must try them all and get to know them well before we get to the next chapter where we will try to edit files and make permanent changes on disks. However, it is recommended that you make some backup copies of the disks with the expanded files and only use the copies for the exercises, just to be safe.

2.1. Listing the Command Names

Words or commands in Forth are very powerful constructs. They have the essence of subroutines in FORTRAN, procedures in PASCAL and PL/I, characters in APL, macro instructions in assembly, and command files in operating systems. Because they are resident in a dictionary in the RAM memory of a computer, they are available for immediate execution or for compilation into other high level commands. Commands in the dictionary are arranged in the form of a linked list so that the execution procedure associated with a particular command can be located quickly by the Forth operating system. A very useful utility command is defined to go through this linked list and print the names of all the commands in the dictionary. It is called WORDS in Forth-83 Standard, a remarkable improvement over the old computerese name VLIST in the figForth model. Typing:

```
WORDS
```

on your keyboard will generate a long list of command names on the terminal, as shown in the following figures. On the list of Forth commands, you will find all the regular Forth commands for arithmetic operations like + , - , * , / , and other division and ratio operators; the stack operators like DUP , DROP , SWAP , OVER and ROT; the memory operators like @ , ! , C@ , and C! ; etc. In fact, all the Forth-83 standard commands are included in this list some where.

WORDS have few equivalent in other language or operating system. The Forth computer can tell you all the commands it knows, which are available for your use, any time you care to browse. In other language or operating system, you have to go look them up in thick manuals and can never be sure that they are really in your system. WORDS reveals the current state of the dictionary. If you add more commands to the dictionary, they will appear at the top of the name list. It is very handy when you are extending the system by defining new commands and add them to the dictionary. In this case you will be interested in the commands on the top of the dictionary and

not the rest of the long listing. You can stop the name listing by pressing any key on the keyboard.

2.2. Vocabulary

Fig. 2.2 shows you how to list the commands in the Forth vocabulary. The dictionary in Forth is usually not a single linked list of commands or commands, but contains a number of logically independent linked lists of commands called vocabularies. The purpose of vocabulary is three-fold: to shorten the time needed to search through the dictionary, to group functional related commands together, and to allow different commands to share the same name. There are nine vocabularies defined in the F83 system. The names of these vocabularies can be displayed by typing the following command:

```
VOCS
```

and nine vocabulary names will be displayed on the terminal. The function and contents of these vocabularies are summarized in Table 2.1.

Table 2.1. Vocabularies in F83

NAME	FUNCTIONS
ROOT	Words to assign vocabulary searching order. All vocabulary must be defined in this vocabulary.
FORTH	The main trunk vocabulary for all standard and system words.
EDITOR	All editing commands.
ASSEMBLER	All words needed to define low level machine code routines.
DOS	Words to use the underlying DOS utility.
USER	User variables.
SHADOW	Words to support shadow screens for comments and documentation.
BUG	Words to support F83 debugger.
HIDDEN	Miscellaneous supporting words not useful to the user.

Executing a vocabulary command makes the specified vocabulary the 'context' vocabulary. The system will search the context vocabulary first to locate a command entered by you. The command WORDS displays only the list of commands in the context vocabulary. Since normally the context vocabulary is the Forth vocabulary, executing WORDS usually displays the command names in the Forth vocabulary as shown in Fig. 2.2. Executing WORDS after a vocabulary command will list the command names in that vocabulary, as shown in the examples in Fig. 2.3-4.

```
ok
ok
WORDS
EMPTY MARK HELLO BACKGROUND: ACTIVATE SET-TASK TASK: RESUME DEBUG LISTING SHOW
(SEMIT) (PAGE) FORM-FEED PAGE #PAGE LOGO L/PAGE FOOTING INIT-PR EPSON SEE (SEE)
ASSOCIATIVE: CASE: MAP OUT DL DU DUMP .HEAD ?.A ?.N DLN EMIT. D.2 .2 A SHADOW
(WHERE) FIX EDIT ED DONE EDITOR DARK AT -LINE BLOT REPLACE INSERT DELETE SEARCH
SCAN-1ST FOUND TO CONVEY (CONVEY) .TO HOP CONVEY-COPY U/D HOPPED VIEW @VIEW COPY
(COPY) ESTABLISH L B N :: MANY TIMES #TIMES WORDS LARGEST IND INDEX .LINE0
TRIAD LIST .SCR ?CR ?LINE RMARGIN LMARGIN HIDDEN 0<= 0>= >= <= U>= U<= MS
FUDGE P! PC! P@ PC@ MULTI SINGLE STOP WAKE SLEEP !LINK @LINK LOCAL INT#
RESTART (PAUSE) UNBUG BUG DOES? DOES-SIZE DOES-OP LABEL UTILITY.BLK CPU8086.BLK
EXTEND86.BLK KERNEL86.BLK VIEWS VIEW-FILES SAVE-SYSTEM FROM OPEN DEFINE B: A: DRIVE?
DIR CREATE-FILE MORE ROOT --> +THRU THRU ?ENOUGH ? (S \ L/SCR C/L RECURSE B Q
DUMP .ID .S DEPTH BYE START OK INITIAL COLD WARM BOOT QUIT RUN IS (IS) >IS
```

```

USER #USER CODE AVOC 2VARIABLE 2CONSTANT DEFINITIONS VOCABULARY DEFER VARIABLE
CONSTANT RECURSIVE ; : ] [ DOES> ;CODE (:CODE) ;USES ASSEMBLER (:USES) REVEAL
HIDE ?CSP !CSP CREATE "CREATE ,VIEW WHILE ELSE IF REPEAT AGAIN UNTIL +LOOP
LOOP ?DO DO THEN BEGIN ?LEAVE LEAVE ?<RESOLVE ?<MARK ?>RESOLVE ?>MARK <RESOLVE
<MARK >RESOLVE >MARK ?CONDITION ABORT ABORT" (ABORT") (?ERROR) ?ERROR WHERE FORGET
(FORGET) TRIM FENCE " ." , " (." ) [COMPILE] [' ' ?MISSING CRASH CONTROL
ASCII DLITERAL LITERAL IMMEDIATE COMPILER EVEN ALIGN C, , ALLOT INTERPRET
STATUS ?STACK DEFINED ?UPPERCASE FIND #THREADS (FIND) HASH VIEW> >VIEW >LINK >NAME
>BODY LINK> NAME> BODY> L>NAME N>LINK FORTH-83 DONE? TRAVERSE \S ( .( >TYPE WORD
'WORD PARSE PARSE-WORD SOURCE (SOURCE) PLACE /STRING SCAN SKIP D.R D. (D.) UD.R
UD. (UD.) .R . (.) U.R U. (U.) OCTAL DECIMAL HEX #S # SIGN #> <# HOLD
NUMBER (NUMBER) NUMBER? (NUMBER?) CONVERT DOUBLE? DIGIT LOAD (LOAD) DEFAULT VIEW#
FLUSH SAVE-BUFFERS EMPTY-BUFFERS IN-BLOCK BLOCK (BLOCK) BUFFER (BUFFER) MISSING
DISCARD UPDATE ABSENT? LATEST? CAPACITY DOS SWITCH FILE? .FILE WRITE-BLOCK
READ-BLOCK >UPDATE BUFFER# >END >BUFFERS INIT-R0 FIRST >SIZE LIMIT DISK-ERROR B/FCB
REC/BLK B/REC B/BUF #BUFFERS QUERY TIB EXPECT CC-FORTH CC DEL-IN CHAR (CHAR)
CR-IN P-IN RES-IN BACK-UP (DEL-IN) BS-IN BEEP BACKSPACES SPACES SPACE TYPE CRLF
(EMIT) (PRINT) PR-STAT CR KEY KEY? (CONSOLE) (KEY) (KEY?) BDOS COMPARE CAPS-COMP
COMP -TRAILING PAD HERE UPPER UPC MOVE LENGTH COUNT BLANK ERASE FILL CAPS BELL
BS BL END? #TIB SPAN >IN BLK VOC-LINK WIDTH 'TIB CONTEXT #VOCS CURRENT CSP
LAST R# DPL WARNING STATE PRIOR SCR EMIT PRINTING IN-FILE FILE HLD BASE OFFSET
#LINE #OUT DP RP0 SP0 LINK ENTRY TOS */ */MOD MOD / /MOD * MU/MOD M/MOD *D
DMAX DMIN D> D< DU< D= D0= ?DNEGATE D- D2/ D2* DABS S>D DNEGATE D+ 2ROT
4DUP 3DUP 2OVER 2SWAP 2DUP 2DROP 2! 2@ WITHIN BETWEEN MAX MIN > < U>
U< ?NEGATE <> = 0<> 0> 0< 0= UM/MOD U*D UM* 2- 1- 2+ 1+ 8* U2/ 2/ 2* 3
2 1 0 +! ABS - NEGATE + OFF ON CTOGGLE CRESET CSET FALSE TRUE NOT XOR OR
AND ROLL PICK R@ >R R> ?DUP FLIP -ROT ROT NIP TUCK OVER SWAP DUP DROP RP!
RP@ SP! SP@ CMOVE> CMOVE C! C@ ! @ (?LEAVE) (LEAVE) J I PAUSE NOOP GO
PERFORM EXECUTE >NEXT BOUNDS (?DO) (DO) (+LOOP) (LOOP) ?BRANCH BRANCH (LIT) UP
UNNEST EXIT FORTH ok
ok

```

Figure 2.2 Forth commands

```

ok
VOCS : SHADOW EDITOR HIDDEN BUG ROOT USER ASSEMBLER DOS FORTH ok
ok
ORDER
Context: FORTH FORTH ROOT
Current: FORTH ok
ok
ok
ok
ASSEMBLER ok
ok
WORDS
2PUSH 1PUSH NEXT DO REPEAT WHILE AGAIN UNTIL BEGIN ELSE THEN IF OV U> U<= U>=
U< > <= >= < 0>= 0< 0<> 0= A?<RESOLVE A?<MARK A?>RESOLVE A?>MARK +RET XOR
XLAT WAIT SUB STOS STI STD STC SHR SHL SCAS SBB SAR SAHF ROR ROL RET REPZ
REPNZ REP RCR RCL PUSHF PUSH POPF POP OUT OR NOT NOP NEG MUL MOVS LOOPNE
LOOPE LOOP LODS LOCK LES LEA LDS LAHF JS JPO JPE JO JNS JNO JNE JMP JLE JL
JGE JG JE JCXZ JBE JB JAE JA IRET INTO INC IN IMUL IDIV HLT DIV DEC DAS
DAA CWD CMPS CMP CMC CLI CLD CLC CBW CALL AND ADD ADC AAS AAM AAD AAA MOV
SS: DS: CS: XCHG SEG INT ESC TEST 13MI 14MI 12MI 11MI 10MI 9MI 8MI 7MI
6MI 5MI 4MI 3MI 2MI 1MI ?FAR FAR INTER WR/SM, R/M, WMEM, MEM, B/L? LOGICAL
RR, ,/C, SIZE, W, OP, BYTE SIZE RMID RLOW BIG? REG? #? SEG? MEM? R16? R8?
MD [W] W [IP] IP [RP] RP S#) #) DS SS CS ES [DI+BP] [SI+BP] [DI+BX]
[SI+BX] [BX] [BP] [DI] [SI] [BP+DI] [BP+SI] [BX+DI] [BX+SI] DI SI BP SP BX DX
CX AX BH DH CH AH BL DL CL AL REGS REG ?<RESOLVE ?<MARK ?>RESOLVE ?>MARK
HERE , C, C; END-CODE ok
ok
ok
DOS WORDS
?DEFINE FILE: .NAME SAVE HEADER SELECT !FCB (!FCB) MAKE-FILE WRITE READ DELETE
SEARCH SEARCH0 CLOSE RESET FCB2 DOS-FCB OPEN-FILE DOS-ERR? FILE-SIZE FILE-IO
FILE-WRITE FILE-READ SET-IO REC-WRITE REC-READ IN-RANGE MAXREC# RECORD# SET-DMA
CLR-FCB FCB1 ?DISK-ERROR DISK-ABORT !FILES ok
ok

```

Figure 2.3 Assembler and DOS commands

ok

```

ORDER
Context: FORTH FORTH ROOT
Current: FORTH ok
  ok
  ok
VOCS : SHADOW EDITOR HIDDEN BUG ROOT USER ASSEMBLER DOS FORTH ok
  ok
ROOT WORDS
WORDS  VOCS  ORDER  DEFINITIONS  FORTH  PREVIOUS  SEAL  ONLY
ALSO   ok
  ok
  ok
SHADOW WORDS
SHOW BRING G CONVEY COPY >IN-SHADOW >SHADOW (>SHADOW)
DISPLACEMENT ok
  ok
  ok
EDITOR WORDS
IBM IBM--LINE IBM-BLOT IBM-DARK IBM-AT SMART DUMB .DUMB (DARK) (BLOT) (AT) GET-ID
NEW EDIT-AT .ALL CHANGED? REDISPLAY .LINE DY DX KT J TILL R D E S F FIND?
BRING G M WIPE JOIN SPLIT X U P O I ?STAMP STAMP ID ID-LEN 'F+ (TILL) (I)
'C#A W K KEEP ?MISSING .BUFS .FRAMED 'VIDEO 'FIND 'INSERT C/PAD ?TEXT EOS
MODIFIED #END #REMAINING #AFTER 'LINE 'CURSOR 'START +T COL# LINE# CURSOR T C
TOP C/SCR INSTALL CHANGED EDITING? AUTO .SCREEN ok
  ok
  ok
HIDDEN WORDS
PR-FLUSH PR-S-PAGE PR-PAGE PR-STOP PR-START P-FOOTING P-HEADING 2SCR 2PR PR TEXT?
SCR#S ((SEE)) .DEFINITION-CLASS
DEFINITION-CLASS .OTHER .USER-DEFER .DEFER .USER-VARIABLE .DOES> .: .VARIABLE .CONSTANT
.IMMEDIATE .PFA .EXECUTION-CLASS
EXECUTION-CLASS .FINISH .UNNEST .(:CODE) .STRING .QUOTE .BRANCH .INLINE .WORD ok
  ok
  ok
BUG WORDS
TRACE 'UNNEST (DEBUG) RES SLOW L.ID PNEXT DEBNEXT DNEXT FNEXT CNT IP> <IP 'DEBUG
ok
  ok
  ok
USER WORDS
DEFER VARIABLE CREATE ALLOT ok
  ok
  ok
FORTH ok
  ok
  ok
ORDER
Context: FORTH FORTH ROOT
Current: FORTH ok
  ok

```

Figure 2.4 Commands in other vocabularies

The vocabulary structure in F83 is significantly improved as compared with the vocabulary structure in the figForth Model. It is more flexible in that you can dynamically change the vocabulary searching sequence and specify up to to eight different vocabularies in the searching sequence. The speed of dictionary searching is also much faster than that in the figForth Model, because all vocabularies in the dictionary are hashed into four threads. In order to locate a command, only a quarter of a vocabulary needs to be scanned. This hashed searching greatly improves the speed of text interpretation and program compilation.

Two commands are used to manage the vocabulary searching sequence: ONLY and ALSO. ONLY initializes the searching sequence and makes ROOT as the only vocabulary available for

searching. In the ROOT vocabulary, all the other vocabulary names must be defined so that they are accessible. After ONLY is executed, executing any other vocabulary command will make that vocabulary the context vocabulary which becomes the first vocabulary to be searched during text interpretation. Executing ALSO pushes the context vocabulary on the top of a vocabulary stack and makes it the first resident vocabulary. Other resident vocabularies already in the vocabulary stack are pushed down so that they will be searched in order after searches in the context and the first resident vocabularies failed to locate a command.

The context vocabulary, for all practical purposes, is the equivalent to the context vocabulary in figForth . The resident vocabularies are extensions of the context vocabulary to allow you to specify the number and the order of vocabularies to be searched in runtime.

To arrange the searching order as DOS-EDITOR-ASSEMBLER-Forth, one has to execute the following command sequence:

```
ONLY FORTH ALSO ASSEMBLER ALSO EDITOR ALSO DOS
```

Here DOS becomes the context vocabulary and EDITOR is the first resident vocabulary to be searched. If a command cannot be located in either DOS or EDITOR, the ASSEMBLER and the FORTH vocabularies will be searched in turn.

Another command ORDER will list the context and the resident vocabularies on the terminal. It is a useful command to assure yourself the context environment you are in at any time. If you executed the above string of vocabulary commands, typing

```
ORDER
```

results in the following display on the terminal:

```
Context: DOS EDITOR ASSEMBLER FORTH ROOT
Current: FORTH ok
```

indicating the desired vocabulary search order. The current vocabulary, in this case FORTH, is the vocabulary to which new commands are added. It will be discussed later.

The command WORDS behaves similarly to VLIST in figForth . However, WORDS only lists the names of commands in the context vocabulary; therefore, WORDS must be preceded by the name of the vocabulary you wish to examine, like FORTH WORDS, DOS WORDS, etc. Since the list of command names always starts with the command defined last, it is often used to see which was compiled last. If there were any error during disk file loading, you can find quickly where compilation stopped.

2.3. Viewing Source Code of Command Definitions

Since there are so many commands in the F83 system, it is impossible for anybody to remember the

meaning and the function of all these commands. Although the compiled object code of a command in the dictionary contains all the information about this command, it is not readily usable to casual users. F83 system provides a very interesting and powerful tool set which permits you to see the source code of any command in the system. This magic command is named 'VIEW'. If you wanted to see how the command LIST was defined, you should type:

```
VIEW LIST
```

and the F83 system will open the file in which LIST was defined and display the screen containing the definition of LIST. On the top of the displayed screen, you will also find the named of the file. This is shown in Fig. 2.4.

To use the viewing facility, you must have all the source files on disks and have them properly inserted into appropriate disk drives. For some computers, the files fit on a single floppy disk. This is the ideal case because you don't have to worry about where a particular file is. For computers with smaller disk drives, the files must be spread over two or more drives. If the required file is not on the disk of your current disk drive, you have to log on to the drive where the file is located and repeat the viewing command, or insert the proper disk in the the log-on drive and repeat the viewing command.

Commands are grouped by their functions and by the order of compilation into six major files in the F83 system:

METAnn.BLK	The meta-compiler
KERNELnn.BLK	The trunk FORTH system. Nucleus, interpreter and compiler.
EXTENDnn.BLK	Vocabulary and file words.
CPUnnnn.BLK	Assembler and CPU dependent words.
UTILITY.BLK	Editor, debugger, decompiler, printing and other utility.
HUFFMAN.BLK	Huffman compression.

where nn or nnnn identifies the CPU for which the F83 system is hosted. 80 for 8080 and Z80, 86 for 8086 and 8088, and 68 for 68000.

If you have to choose which files to put on a disk for viewing, I suggest that you put UTILITY.BLK, KERNELnn.BLK, and EXTENDnn.BLK on one disk and use it for viewing, because they comprise the majority of useful commands that you might be interested in browsing.

F83 also comes with a built-in decompiler which can regenerated the source code from the object code in the dictionary. The decompiler command is 'SEE', followed by the name of the command you want to decompile. For example:

```
SEE LIST
```

will display the sequence of commands which define the function of LIST on the terminal. The displayed sequence of commands does not match exactly the sequence in the original source code,

because the control structures are not decompiled but simply represented by the corresponding runtime routines. Nevertheless, the decompiled sequence does reveal the composition of the source code faithfully. The advantage of the decompiler over the viewing facility is that the decompiler is always available for you to browse commands, even without the disk files.

The result of SEE LIST is also shown in Fig. 2.5. .

```

ok
ok
VIEW LIST is in A:UTILITY.BLK screen 4
Scr # 4      A:UTILITY.BLK
0 \ Managing Source Screens      22Mar84map
1 : .SCR (S -- ) ." Scr # " SCR ? 8 SPACES FILE? ;
2 : LIST (S n -- )
3   1 ?ENOUGH CR DUP SCR ! .SCR L/SCR 0
4   DO CR I 3 .R SPACE
5     DUP BLOCK I C/L * + C/L -TRAILING >TYPE KEY? ?LEAVE
6   LOOP DROP CR ;
7 : TRIAD (S n -- )
8   12 EMIT ( form feed ) 3 / 3 * 3 BOUNDS DO I LIST LOOP ;
9 : .LINE0 (S n -- )
10  DUP 3 MOD 0= IF CR THEN CR DUP 3 .R SPACE
11  BLOCK C/L -TRAILING >TYPE ;
12 : INDEX (S n1 n2 -- )
13   2 ?ENOUGH 1+ SWAP DO I .LINE0 LOOP CR ;
14 : IND (S n -- )
15  BEGIN DUP .LINE0 1+ KEY? UNTIL DROP ;
ok
ok
ok
ok
ok
SEE LIST
: LIST 1 ?ENOUGH CR DUP SCR ! .SCR L/SCR 0 (DO) 38 CR I 3 .R SPACE DUP
BLOCK I C/L * + C/L -TRAILING >TYPE KEY? (?LEAVE) (LOOP) -34 DROP CR ; ok
ok
ok

```

Figure 2.5 VIEW and SEE

2.4. Shadow Screen Documentation

Since most people think that a Forth screen of 1024 bytes is too small to put inline documentation with the code in the same screen, the shadow screen technique was developed to give you an extra screen to write comments and documentation for each source screen. This documentation screen is the shadow of the source screen.

F83 divides a screen file into two equal parts: the first half will be used for source code and the second half for documentation. one can toggle between a source screen and its shadow screen with the commands A and L. After viewing the source code in a source screen, you can type A L and switch to the shadow screen to see the comments and documentation. Documentation thus provided in the F83 system is quite extensive, and you are encouraged to examine the shadow screens with their respective source screens. The shadow screens generally bring out the purpose and over-all function of commands which are not obvious in the source definition.

2.5. Files in F83

F83 uses MS-DOS or CP/M operating system to access the terminal and the disk files. Using a readily available operating system to host the F83 system has the advantage that it can be transported to a large number of computers with that operating system. It also allows the partitioning of the F83 system into several named files which are easier to handle than simply blocked disk. Within a file, however, F83 system still deals with program or data in the 1024 byte block format as required by the Forth-83 standard. Most of the elementary file functions are defined as Forth commands. However, you only need a few high level commands to use files to store and to retrieve programs and data.

Three simple Forth commands have functions similar to their DOS or CP/M counterparts: `DIR` lists on the terminal all the files on the current disk drive, `A:` makes drive A the current drive, and `B:` makes drive B the current drive. All file activities are processed for files on the current drive.

All the Forth commands using the disk mass storage, such as `BLOCK`, `BUFFER`, `FLUSH`, etc., access the current file on the current disk. A file becomes the current file when it is opened by the command `OPEN <filename>`, and subsequent disk commands are directed to this file. In our previous example of the command `VIEW`, which displays the screen containing the source code in a file, the command `VIEW` actually opens the file containing the command and displays the requested block on the terminal. If you want to examine or to modify data or source in a specific file, you have to open it explicitly. Once a file is opened, you can display any block within that file.

The size of a file is usually specified when the file was created. The size in number of 1024 byte blocks can be recalled by the command `CAPACITY`. Execute `CAPACITY` and the number of blocks in the current file is returned on the stack. Source code files in the F83 system with the extension `BLK` are arranged to have the source code in the first half of the file and the shadow documentation in the second half.

To examine the contents of a `BLK` file, you can use the command `INDEX` to display the first lines in a range of screens. For example, to display the first lines of all the source code screens, you can type:

```
0 CAPACITY 2/ INDEX
```

and the first lines of those screens will be displayed on the terminal. By convention, the first line in a screen should always be a comment to the contents of this screen. Thus `INDEX` gives us the

information equivalent to a directory in a file. An example of the index listing of the UTILITY.BLK file is shown in Fig. 2.6.

After you identify any screen of your interest, you can examine the detailed contents of this screen by the command LIST, preceded by the screen number:

```
1 LIST
```

It will display the first text screen in a file. In all the F83 source code files, screen one is the load screen of the file, i. e., it contains commands that will load or compile the source screens in the rest of the file. There are also some comments in screen one indicating the packaging of the screens in the file.

To display the shadow documentation of any source screen, you should type:

```
A L
```

The command A uses CAPACITY to calculate the screen number of the associated shadow screen and makes it the current screen. the command L displays the current screen. Executing A and L again will display the source screen again.

2.6. Printing Utility

To make hard copy of the source screens and shadow screens, a simple method is to let the printer follow the terminal display. In the CP/M systems you can type the control P code on the keyboard to turn on the printer. Any character hereafter displayed on the terminal will also be printed. Now you can use any of the listing commands discussed in the last section to print index of a file or individual screens. However, you do not have control on the printing format. F83 provides some utility commands to print source code and shadow screens. If you have an EPSON printer capable of printing in condensed format, you can print the source screens side by side with their shadows on single 8.5" by 11" paper, which is very convenient when studying the source code.

The print utility allows you to print a range of screens on a printer. It must be properly initialized for your printer. If you do have an EPSON printer you have to initialize it by the following commands:

```
' EPSON IS INIT-PR
```

which initialize the vectored command, INIT-PR. The print format is 6 screens to a page with two 3 screen columns. The printer must be able to print 132 characters per line to fit two screens side by side.

```
ok
ok
ok
DIR
CLOCK   BLK   CPU8086  BLK   EXTEND86  BLK   F83      COM   F83-FIXS  TXT
```

```

HUFFMAN BLK  KERNEL86 BLK  META86  BLK  UTILITY BLK  2-6      TXT  ok
ok
ok
OPEN EXTEND86.BLK ok
ok
ok
CAPACITY . 0 ok
ok
ok
0 15 INDEX

0 \          The Rest is Silence          03Apr84map
1 ( Load Screen to Bring up Standard System      07Apr84map
2 \ Load up the system          08MAY84HHL

3 ( Commenting and Loading Words          16Oct83map
4 \ The ALSO and ONLY Concept          07Feb84map
5 \ The ALSO and ONLY Concept          06Apr84map

6 \ Load Screen for DOS Interface          07Apr84map
7 \ DOS Interface          10Apr84map
8 \ Create File Control Blocks          19Apr84map

9 \ Save a Core Image as a File on Disk          06Apr84map
10 \ Display Directory          13Apr84map
11 \ Define and Open files          04Apr84map

12 \ Viewing Source Screens          08MAY84HHL
13 \ My normal configuration          07Apr84map
14

15
ok
ok
ok
1 LIST
Scr # 1          A:EXTEND86.BLK
0 ( Load Screen to Bring up Standard System      07Apr84map
1 ) CR .( Loading system extensions.) CR
2 2 VIEW# ! ( This will be view file# 2 )
3 WARNING OFF
4
5 3 LOAD ( BASICS )
6 6 LOAD ( FILE-INTERFACE )
7 FROM CPU8086.BLK 1 LOAD ( Machine Dependent Code )
8 FROM UTILITY.BLK 1 LOAD ( Standard System Utilities )
9
10 WARNING ON
11 -->
12
13
14
15
ok
ok
ok
ok

```

Figure 2.6 Files and directory commands

The command to print a range of screens is SHOW:

```
1 30 SHOW
```

will print screens 1 to 30.

There are two versions of SHOW in F83. The version in Forth prints 6 screens per page and the version in the SHADOW vocabulary prints 3 screens of source with their corresponding shadow screens:

prints source screens 1 to 30, 3 screens to a page with 3 shadow screens.

If your printer cannot handle 132 columns per line, you will have to use the command TRIAD to print three screens on a page.

To obtain the complete listing of a file in the source-shadow format, there is a simple command LISTING. LISTING was used to generate all the source listings as distributed with the F83 systems, with file name, page number, and footing. .

2.7. Debugger

The debugger is designed to let you single stepping through the execution sequence of a high level command. To invoke the debugger to trace a command, issue the following command:

```
DEBUG <name>
```

where <name> is the command to be debugged. Nothing happens at this point. DEBUG sets things up so that when the command is executed you will get a single step trace showing the command within <name> that is about to be executed and the contents of the parameter stack.

While single stepping through a command, the name of the next command to be executed and the contents of the parameter stack are displayed on the CRT terminal. The debugger then waits for a key stroke on the terminal keyboard. Any key will cause the next command to be executed and the debugging information displayed. Three special keys, C, F, and Q, have the following functions:

```
Q      Quit the debugging process and restore the debugged word to its original state for normal
      execution.
C      Turn off the single stepping mechanism and let execution run to completion.
F      Temporarily return to Forth system so that you can execute other Forth commands, for example,
      to change the data stack items. You must type RESUME to come back and continue the debugging
      process.
```

An example to single step through the execution of 1 LIST is shown in Fig. 2.7. Typing Q at the bottom of the list terminates the execution.

```
ok
ok
OPEN UTILITY.BLK ok
ok
ok
DEBUG LIST ok
ok
ok
1 LIST      1
1          -->    1      1
?ENOUGH    -->    1
CR         -->
          1
```

```

DUP      -->    1    1
SCR      -->    1    1    2998
!        -->    1
.SCR     --> Scr # 1          A:UTILITY.BLK    1
L/SCR   -->    1    16
0        -->    1    16    0
(DO)    -->    1
CR       -->
1
I        -->    1    0
3        -->    1    0    3
.R       -->    0    1
SPACE   -->    1
DUP     -->    1    1
BLOCK   -->    1    64000
I       -->    1    64000    0
C/L     -->    1    64000    0    64
*       -->    1    64000    0
+       -->    1    64000
C/L     -->    1    64000    64
-TRAILING -->    1    64000    64
>TYPE   --> \ Load Screen to Bring up Standard System    07Apr84map    1
KEY?    -->    1    0
(?LEAVE) -->    1
(LOOP)  -->    1
CR       -->
1
I        -->    1    1
3        -->    1    1    3
.R       -->    1    1
SPACE   -->    1
DUP     --> Unbug
ok
ok

```

Figure 2.7 Debugging LIST

Chapter 3. Using the F83 System

I suppose that you are now ready and eager to use the F83 system to do some programming on your own. In this chapter I will try to give you some tips on how to use F83 to write programs and save them on disk for posterity. It is not my job to teach you how to programming in Forth. There are too many books on this subject in the book stores. What I want to do is to discuss many useful commands in the F83 system which are very helpful to generate code, test and debug the code, and save them on the disk in files. Most of them are specific to the F83 system. You will find all of them in the source code form and commented in the shadow screens if you study diligently the entire F83 listings. Rather than postpone the pleasure in exploring this system until you learn all about it, I think you will appreciate a few tips to get started immediately and do something useful.

Again I have to remind you to make backup copies of your original F83 system disks. If you are through with the viewing facility and do not need all the F83 source files, you may want to use a formatted blank disk in the currently logged disk drive for the exercises we will do here. Since all the Forth commands are loaded into the dictionary in RAM memory, you really do not need those source files unless you want to copy and use some of the screens. When we invoke the editor, we will make permanent changes on the disk. You would certainly want a good F83 system backed up so you have something to fall back to.

3.1. Create Your Own File

To write your own programs, the first thing you have to do is to find some space on the disk to store your program. You can get disk space in three different ways:

1. Open an existing file and use screens in it. You will destroy some of the information in this file.
2. Extend an existing file and use the increased space at the end of this file to store your code.
3. Create your own file and do whatever you want with it.

If you wanted to modify F83 to suit your own computer or to make it perform better, you probably will use the first approach. Just be sure that the disk is not write-protected so that you will be able to save your program. Simply OPEN the file you want to use and select a screen by the command

```
n LIST or n EDIT.
```

Then you can use editor commands to enter new code into the screen or edit its contents. We will discuss the editor commands later.

If you chose the second approach to extend an existing file, you should first open the desired file and use the command MORE to add more screens to this file. For example,

```
10 MORE
```

will add 10 screens to the end of the current file. All the added screens are filled with blank characters. Now, the command CAPACITY will return the total screen number on the stack. From this number you can select any of the added screens to enter your program. One problem with this approach is that the shadow screens in the file will not match with the corresponding source screens.

To create a new file on the disk for your private use, you have to use the command CREATE-FILE. Following is an example:

```
30 CREATE-FILE MYFILE.BLK
```

where MYFILE.BLK is the name of the new file, and the length of the file is 30 Forth blocks or 30K bytes. After a file is created this way, it can be opened by the OPEN command:

```
OPEN MYFILE.BLK
```

and now we can use the command LIST or EDIT to select one screen in this file to enter new text or other information. The file name must conform to the rules of the disk operating system. Usually the name can contain up to 8 characters with a three character extension.

F83 allows you to open 2 files at a time so that screens can be copied from one file to the other. The command FROM opens the second file which can be read while the current file can be written. For example,

```
FROM YOURFILE.BLK 1 10 COPY
```

opens YOURFILE.BLK file as the input file and keeps MYFILE.BLK file as the current file. Of course, you have to create YOURFILE before you can open it. The command COPY which normally would copy screen 1 to screen 10 in MYFILE.BLK will now copy screen 1 from YOURFILE.BLK file to screen 10 in MYFILE.BLK. When a file is OPEN'ed, it is made both the current file and the input file. When a file is opened by the command FROM, the file becomes the input file only and can be used with the current file.

To copy a range of screens in the current file from one place to another, the command to use is CONVEY. First you have to tell the F83 system how many screens you want to skip over during copying. If you want to copy screens 1-6 to screens 12-17, you should give the following commands:

```
11 HOP 1 6 CONVEY  
or 1 6 TO 12 CONVEY
```

If the number before HOP is negative, the range of screens will be moved towards the beginning of the file.

If you want to copy screens 1-20 in YOURFILE.BLK to HISFILE.BLK and put them down as screens 11-30, the commands are:

```

OPEN HISFILE.BLK FROM YOURFILE.BLK
and 10 HOP 1 20 CONVEY
or 1 20 TO 11 CONVEY

```

You should be very careful about these commands because two files are involved. You always read from the input file and write to the current file. In case that you want to copy screens from the current file to the input file, you must use the command SWITCH to exchange the current and the input files before issuing COPY or CONVEY command.

3.2. The Editor

There are two text editors in the F83 system: a regular line editor and a screen editor. The line editor processes the text one line at a time and can be used with any type of terminal. Since most terminals can display 24 80 column lines, there are more than enough space on the terminal screen to display an entire Forth screen in the 16 by 64 block format, with ample space to enter editing commands. The line editor is adequate for all editing and programming purposes. The only drawback is that after entering 8 lines of commands, the listed screen starts to roll off the top of the terminal display and you will have to re-list it to keep it in the view. The screen editor keeps the listed screen on the top of the terminal display and refreshes its contents after any editing command is executed.

The line editor is compatible with the editor described in Brodie's book 'Starting Forth'. The most often used editing commands are summarized in Table 3.1.

Table 3.1. Editor Commands

Block Editing Commands:	
n LIST	Display screen n and make it the current screen.
L	Display the current screen.
N L	Display the next screen.
B L	Display the previous screen.
A L	Toggle between the current screen and its shadow screen.
UPDATE	Mark the current screen to be saved to the disk file.
SAVE-BUFFERS	Write all updated screens to their respective disk files.
FLUSH	SAVE-BUFFERS and de-allocate the buffers.
n LOAD	Interpret the text in screen n.
Line Editing Commands	
n T	Select line n as the current line for editing.
P xxxx	Put the string xxxx in the current line.
U xxxx	Insert the string xxxx under the current line.
X	Delete the current line.
n NEW	Input multiple lines of text starting at line n.
String Editing Commands	
F xxxx	Find string xxxx from the current cursor position and place the cursor at the end of xxxx.
D xxxx	Find string xxxx and delete it.
I xxxx	Insert string xxxx after the current cursor and move the cursor to the end of xxxx.
TILL xxxx	Delete all text till the end of string xxxx in the current line.
J xxxx	Delete text till the beginning of string xxxx. (Justify).

To use the line editor, you first have to select a screen as the current editing screen by the command:

```
1 LIST EDITOR
```

Then, you can use the line editing commands to enter text into this screen. The `NEW` command is especially useful in entering several contiguous lines into the screen. If screen 1 is a blank screen, you probably will start with:

```
0 NEW
```

and follow with up to 16 lines of text. Two consecutive carriage returns will terminate the `NEW` command. If you find any error in the entered text, you can use the string editing command to find text strings, delete strings, and also insert strings. When you are satisfied with the contents of the screen, you can interpret or compile the screen using the command:

```
1 LOAD
```

and start to debug your program entered in screen 1. Usually you will find some errors or bugs in the program, causing the interpreter to abort during the loading process or giving wrong results when you execute commands defined in this screen. You will then have to find the cause of the problem and fix the bug, again using the editor.

F83 has a generic screen editor. However, this screen editor must be customized to run on your terminal. An example to install a screen editor for the ADM-3A dumb terminal is shown in the `README` file which is also a good example on the command sequence in using the line editor. Terminal characteristics are specified in four commands:

```
AT           Move the display cursor to a specified screen coordinate.
DARK        Clear the screen and home the cursor.
-LINE       Delete current line and roll up the rest of the screen.
BLOT        Erase till the end of line.
```

These four commands have to be vectored to the commands which perform these functions on the terminal you are using.

There are some new features in the F83 screen editor. An automatic ID stamping utility inserts an identification string on the top right of every screen being edited. This is very convenient to keep the date and person doing the entry and modifications. `FIX xxxx` will locate the source command of `xxxx` and display the screen of this command. It also invokes the editor to let you edit the command.

`WHERE` is also a very useful command during program development. When an error causes the text interpreter to abort, executing `WHERE` will call `EDIT` to display the screen where the error occurred while loading and the cursor will be pointing right at the command causing trouble. All

the editing commands can then be used to fix the problem.

To use the screen editor, you have to select a screen as your current editing screen. Instead of the LIST command as used in the line editor, you should use the EDIT command:

```
23 EDIT
```

It invokes the screen editor to edit screen 23. The screen editor first checks the ID field at the end of line 0. If this field is blank, it will ask you to input a ten character string as a stamp to fill the ID field. The ID stamp helps you to keep track of the modifications you make on this screen. The contents of the screen are then displayed in the screen window on the top of the terminal display. You can now enter any of the line editing commands and the results will be shown immediately in the screen window. The command dialog will be scrolled in the command text window at the bottom of the display screen while the screen text is stationary in the screen window on the top of the display.

After you have completed the editing work and decide to leave the screen editor, you should type:

```
DONE
```

and the editor will save this screen to the disk file if you made any modification. The terminal display will be returned to its normal scrolling mode. To re-enter the screen editor to edit the same screen you just parted, you can use:

```
ED
```

without specifying the screen number as you would using EDIT.

3.3. Loading and Testing Program

Screens of 1024 bytes are about the optimal size for writing and testing programs. The limited size forces you to modularize your program and eases the tasks of testing and debugging the program.

A source screen may contain three types of information: commands to be interpreted or executed, new commands to be compiled to the dictionary, and comments. The text interpreter treats the source text the same way as it treats text entered from the keyboard. The command to ask the text interpreter to interpret source text in a screen is LOAD:

```
1 LOAD
```

will cause the system to fetch screen 1 from the current file and interpret its contents.

F83 has a few other commands to load source screens. They are collected in Table 3.2. here.

Table 3.2. Loading Commands

n LOAD	Interpret source text in screen n in the current file.
n m THRU	Interpret sequentially the source text in screens n to m.
n +LOAD	Load the screen n blocks from the current screen.
n m +THRU	Load a range of screens n blocks offset from the current screen.
-->	Exit the current screen and load the next screen immediately.

F83 system allows you to open two files at the same time by the command FROM. After you open a file using FROM, the LOAD command will load a screen from the from file instead of the current file. This way you can load utility programs from other files while still maintain the file you are using as the current file. However, LOAD restores the current file to be the input file at the end of its operation, so that you will be able to refer to the current file. Thus you can only load one screen from the FROM file with the LOAD command.

3.4. Memory Dump

LIST allows you to display text data in a screen. However, screens can also be used to store binary data or object code. Binary data cannot be listed on the terminal or printed by a printer. If binary data are accidentally send to the terminal or printer, usually the terminal or printer will print garbage with lots of form-feeds. Sometimes they can be locked up by some binary code and you will have to turn off the entire system and re-boot. F83 provides a few commands to let you examine binary data in memory or in disk files.

The dump utility gives you a formatted hex dump with the ASCII text corresponding to the hex bytes, on the right hand side of the screen. Three commands are available to specify the desired dumping actions. DUMP requires an address and a byte count on the stack to display the contents of a range of memory. The dump is always in hex, but the current base is not disturbed. DU dumps 64 bytes at the specified address. The address is incremented by 64 to facilitate dumping the next memory range of 64 bytes.

Examples of using these commands are:

```
HEX 100 80 DUMP ( Dump 128 bytes starting from 100H.)
DECIMAL 256 DU DU DROP ( Do the same thing as above.)
```

DL dumps the specified line on the current screen, with the line number as the input on the stack. This dump is useful in detecting nonprintable characters in the screen which disturb interpretation and compilation.

```
13 DL ( Dump the 13th line in the current editing screen.)
```

A dumping example is shown in Fig. 3.1.

```

ok
ok
HEX ok
ok
ok
0 400 DUMP
\ 1 2 3 4 5 6 7 8 9 A B C D E F V123456789ABCDEF
0 CD 20 FF 9F 00 9A F0 FE 1D F0 DE 01 21 04 4B 01 M ....p~.p^!.K.
10 21 04 56 01 21 04 21 04 01 03 01 00 02 FF FF FF !.V.!!.....
20 FF FF FF FF FF FF FF FF FF FF FF FF FF 22 05 F2 EC .....".tl
30 6A 05 14 00 18 00 6A 05 FF FF FF FF 00 00 00 00 j.....j.....
40 05 00 00 00 00 00 00 00 00 00 00 00 00 00 00 00 .....
50 CD 21 CB 00 00 00 00 00 00 00 00 00 00 20 20 20 M!K.....
60 20 20 20 20 20 20 20 20 00 00 00 00 00 20 20 20 .....
70 20 20 20 20 20 20 20 20 00 00 00 00 00 00 00 00 .....
80 00 0D 20 20 20 53 45 54 20 42 4C 41 53 54 45 52 .. SET BLASTER
90 3D 41 30 0D 64 64 72 65 73 73 2E 20 20 46 6F 72 =A0.ddress. For
A0 20 65 78 61 6D 70 6C 65 3A 0D 20 6F 6E 20 4E 54 example:. on NT
B0 56 44 4D 2C 20 73 70 65 63 69 66 79 20 61 6E 20 VDM, specify an
C0 69 6E 76 61 6C 69 64 0D 20 6F 6E 6C 79 2E 0D 00 invalid. only...
D0 00 00 00 00 00 00 00 00 00 00 00 00 00 00 00 .....
E0 00 00 00 00 00 00 00 00 00 00 00 00 00 00 00 .....
F0 00 00 00 00 00 00 00 00 00 00 00 00 00 00 00 .....
100 E9 34 2B E9 2B 2B 52 50 AD 8B D8 FF 27 03 10 00 i4+i++RP-.X.'...
110 00 85 46 4F 52 54 C8 9A 29 63 66 D2 66 3D 66 ED ..FORTH.)cfrf=fm
120 65 00 00 43 43 4D 4D 89 76 00 8B F3 EB DA 04 10 e..CCMM.v..skZ..
130 00 00 84 45 58 49 D4 39 01 8B 76 00 45 45 EB C8 ...EXIT9..v.EEkH
140 04 10 30 01 86 55 4E 4E 45 53 D4 39 01 87 EC 56 ..0..UNNEST9..lv
150 87 EC 5E 43 43 53 EB B0 43 43 53 EB AB 05 10 42 ..l^CCSkOCCSk+..B
160 01 82 55 D0 58 01 72 2C 43 43 8B 07 EB 99 43 43 ..UPX.r,CC..k.CC
170 8B 07 03 06 66 01 EB 8F 05 10 00 00 85 28 4C 49 ....f.k.....(LI
180 54 A9 84 01 AD E9 7F FF 09 10 0F 01 86 42 52 41 T)..-i.....BRA
190 4E 43 C8 95 01 8B 34 E9 6E FF 09 10 00 00 87 3F NCH...4in.....?
1A0 42 52 41 4E 43 C8 A8 01 58 09 C0 74 E8 46 46 E9 BRANCH(.X.@thFFi
1B0 56 FF 0B 10 7A 01 86 28 4C 4F 4F 50 A9 BF 01 B8 V...z..(LOOP)?.8
1C0 01 00 01 46 00 71 CE 83 C5 06 46 46 E9 39 FF 0B ...F.qN.E.FFi9..
1D0 10 B4 01 87 28 2B 4C 4F 4F 50 A9 DD 01 58 EB E2 ..4..(+LOOP)].Xkb
1E0 0C 10 D1 01 84 28 44 4F A9 EB 01 58 5B 4D 4D 8B ..Q..(DO)k.X[MM.
1F0 14 89 56 00 46 46 81 C3 00 80 4D 4D 89 5E 00 29 ..V.FF.C..MM.^.)
200 D8 4D 4D 89 46 00 E9 FF FE 0C 10 E2 01 85 28 3F XMM.F.i~.b..(?
210 44 4F A9 15 02 58 5B 39 C3 75 D2 8B 34 E9 E8 FE DO)..X[9CuR.4ih~
220 0C 10 8A 01 86 42 4F 55 4E 44 D3 23 01 E4 03 82 .....BOUNDS#.d..
230 05 D4 03 4B 01 0E 10 22 02 85 3E 4E 45 58 D4 68 ..T.K...".>NEXTH
240 01 08 01 0E 10 5F 01 87 45 58 45 43 55 54 C5 51 .....EXECUTEQ
250 02 5B FF 27 0E 10 0B 02 87 50 45 52 46 4F 52 CD [.'.....PERFORM
260 62 02 5B 8B 1F FF 27 43 43 8B 1F FF 27 43 43 8B b.[...'CC...'CC.
270 07 03 06 66 01 8B D8 8B 1F FF 27 0E 10 9C 01 82 ...f..X...'.....
280 47 CF 84 02 C3 0E 10 37 02 84 4E 4F 4F D0 90 02 GO..C..7..NOOP..
290 E9 75 FE 0E 10 56 02 85 50 41 55 53 C5 9F 02 E9 iu~..V..PAUSE..i
2A0 66 FE 0F 10 45 02 81 C9 AA 02 8B 46 00 03 46 02 f~..E..I*..F..F.
2B0 E9 54 FE 0F 10 87 02 81 CA BB 02 8B 46 06 03 46 iT~.....J;..F..F
2C0 08 E9 43 FE 0F 10 95 02 87 28 4C 45 41 56 45 A9 .iC~.....(LEAVE)
2D0 D2 02 83 C5 04 8B 76 00 45 45 E9 2B FE 0F 10 C6 R..E..v.EEi+~..F
2E0 02 88 28 3F 4C 45 41 56 45 A9 EC 02 58 09 C0 75 ..(?LEAVE)l.X.@u
2F0 E1 E9 14 FE 10 10 DF 02 81 C0 FC 02 5B FF 37 E9 ai.~.._..@|.[.7i
300 06 FE 10 10 A4 02 81 A1 0A 03 5B 8F 07 E9 F8 FD ..~.$!..[.ix}
310 10 10 7D 02 82 43 C0 19 03 5B 29 C0 8A 07 E9 E6 ..}..C@..[.)@..if
320 FD 10 10 12 03 82 43 A1 2A 03 5B 58 88 07 E9 D7 }.....C!*.[X..iW
330 FD 11 10 23 03 85 43 4D 4F 56 C5 3D 03 FC 8B DE }..#..CMOVE=..|^
340 8C D8 8E C0 59 5F 5E F2 A4 8B F3 E9 BA FD 11 10 .X.@Y_^r$.si:}..
350 33 03 86 43 4D 4F 56 45 BE 5B 03 FD 8B DE 8C D8 3..CMOVE>[.].^X
360 8E C0 59 49 5F 5E 01 CF 01 CE 41 F2 A4 8B F3 FC .@YI_^..O.NAr$.s|
370 E9 95 FD 12 10 50 03 83 53 50 C0 7D 03 8B C4 E9 i.}..P..SP@}..Di
380 85 FD 12 10 75 03 83 53 50 A1 8C 03 5C E9 78 FD .}..u..SP!..ix}
390 12 10 B5 02 83 52 50 C0 9A 03 8B C5 E9 68 FD 12 ..5..RP@...Eih}.
3A0 10 92 03 83 52 50 A1 A9 03 5D E9 5B FD 13 10 F6 ...RP!..|i[}..v
3B0 02 84 44 52 4F D0 B8 03 58 E9 4C FD 13 10 AF 03 ..DROP8.XiL}../.
3C0 83 44 55 D0 C6 03 58 50 E9 3C FD 13 10 84 03 84 .DUPF.XPi<}.....
3D0 53 57 41 D0 D6 03 5A 58 E9 2B FD 13 10 CD 03 84 SWAPV.ZXi+}..M..
3E0 4F 56 45 D2 E6 03 5A 58 50 E9 1A FD 14 10 BE 03 OVERf.ZXPi.}>..
3F0 84 54 55 43 CB F7 03 58 5A 50 E9 09 FD 14 10 A1 .TUCKw.XZPi.}...! ok
ok
ok

```

Figure 3.1 Memory dump

3.5. Debugging Your Program

A program usually does not work and you will have to find out why it doesn't work and try to fix it. The advantage of Forth is that you can fix bugs quickly because loading a screen and testing the commands in a screen is simple and fast. It allows you to experiment and try out ideas and methods to solve your problem. If you limit yourself writing programs one screen at a time and test the commands in the screen fully, the problem can be solved very efficiently. Of course, you should make it easier for yourself by writing short commands which are easy to test, and if there is a problem, easy to spot the problem and fix it. Choosing good names for your commands and commenting the stack effects will make the program more readable and easier to modify or update.

F83 system gives you a powerful debugging tool in case you cannot spot the bug by staring at the source code long and hard. The F83 debugger allows you to single step through a colon command and shows you the contents of the data stack at each step. By examining the data stack at each step, it is a simple matter to find when and how the bug gets into your program. During the tracing, you can jump back into Forth to poke around and change things like the data stack before continue the tracing. These functions in the debugger really help a Forth user to produce clean code.

There are two steps in using the debugger. First you have to prepare the command you want to trace use the DEBUG command. Then, you have to execute the command in the normal way it is used, with necessary data stack parameters. The command is then executed in steps. The computer displays the name of the command in the command to be executed next and the contents of the data stack. You have to press a key on the keyboard for it to step to the next command. For example, we would like to debug the command LIST:

```
DEBUG LIST
```

It sets up the command LIST so that it will be executed in steps. Then we can debug LIST by listing screen 1 using the patched LIST:

```
1 LIST
```

Now, LIST will be executed one step a time to allow you the examine the data stack at each step. The sequence of commands are shown in Fig. 2.7.

During single stepping, you can use three keys to divert the stepping action:

```
F      temporarily enter FORTH so that you can use regular FORTH commands to change stack values
      and anything else you care to do. executing resume allows you to come back to the proper
      place to continue single stepping.
C      executing the rest of the definition continuously to the end without pausing.
Q      quit the debugger immediately and restore the debugged word to it original state.
```

If you keep your commands short and thoroughly test them as they are defined, you may not need this debugger. However, every once a while you will find that the capability in single stepping through a command is very helpful in spotting some obscure bugs.

3.6. The 8086 Assembler

F83 is available for 8080/Z80, 8086/88, 68000, and also 6502 CPUs. Each version of F83 comes with an assembler to assemble code routines in the machine code of the host CPU. The assembler is useful if you want to write machine code routines to speed up the execution of your program or to utilize special hardware features in your computer system. Since Forth is fast and quite efficient, and has the commands to access memory and I/O directly, it is not necessary to dip into the machine code in normal circumstances. However, there are occasions that you have to optimize the program. As the assembler for your CPU is provided free in F83, we might just as well learn to use it for the fun of it. Since this book is devoted to the version of F83 for IBM PC, I will only discuss the 8086 assembler.

Another reason to describe the assembler in detail is that the kernel of the F83 system is written using the same assembler. Therefore, it is mandatory that you are familiar with the 8086 assembler if you want to dig into the F83 system and to apply it to do useful work.

8086 has 12 registers in its CPU. All these registers can be referenced in the assembler. However, the F83 system uses four of the registers to implement the Virtual Forth Computer. These registers used by Forth have special names to indicate their special functions in Forth, and they should be preserved inside the code command. Table 3.3. shows the 8086 registers and the mapping with Forth registers.

In code routines, RP and IP must be restore if they have to be used. SP is used for data stack and must be maintained to pass parameters between commands. AX, CX, DX, and DI can be used freely. W points to the code field of the command currently being executed. If this address is not needed, W register can also be used freely. The segment pointers can be used to address memory outside of the 64K code space, but they must also be restored to the original state before the end of the code routine.

The 8086 registers can be used in a number of different addressing modes. The addressing modes defined in the Forth 8086 assembler are shown in Table 3.4.

Table 3.3. 8086 Registers and Forth Registers

8086	Forth	Function of register
AX		Accumulator
CX		Counter
DX		I/O register
BX	W	Current word pointer
SP	SP	Data stack pointer
BP	RP	Return stack pointer
SI	IP	Instruction pointer
DI		Scratch
ES		Extra segment pointer
CS		Code segment pointer
SS		Stack segment pointer
DS		Data segment pointer

Table 3.4. Register Addressing Modes and Mnemonics

Addressing Mode	Mnemonics
8 bit register mode	AL CL DL BL AH CH DH BH
16 bit register mode	AX CX DX BX BP SP SI DI ES CS SS DS W RP IP
Indirect register mode	[SI] [DI] [BP] [BX] [RP] [IP] [W]
Indirect with index	[BX+SI] [SI+BX] [BX+DI] [DI+BX] [BP+SI] [SI+BP] [BP+DI] [DI+BP]
Immediate	#
Immediate address	#)
Inter-segment address	S#)

All 8086 machine instructions are implemented in this F83 8086 assembler, making it rather complicated. It is not appropriate to discuss all the possible combinations of the instructions and the addressing modes. Here I shall discuss a few important aspects in making use of this assembler. You should read the chapter on the assembler to study how the machine instructions are assembled and how the addressing modes are processed to put together complete machine instructions. It is also a good idea to study the code commands in the Forth kernel, where we have hundreds of fine examples of code commands. The best way to write a code command is to find one of similar function in the kernel and make modifications to the existing code to put in the function you need.

A code command must start with the command `CODE` which creates a header in the dictionary and invokes the `ASSEMBLER` vocabulary to do the assembly work. Then a sequence of assembler mnemonic commands are executed to assemble machine instructions into the body of the code command. At the end of the code command, there must be a command to return control to the Forth interpreter and a command to terminate the code command:

```
CODE <name>
<assembly commands>
<return command>
END-CODE
```

where `<name>` is the name of the new code command. `CODE` only creates the header. The Forth text interpreter is still in control after `CODE`, and the sequence of assembly commands are executed. Executing an assembly command causes a machine instruction to be assembled to the dictionary. `END-CODE` terminates the assembly process and makes the new code command

available for searching and compiling.

An assorted collection of assembly commands are shown in Table 3.5. Note that the assembler syntax is still reverse Polish: the operands are put before the assembly command. The operands, whether they are addresses, immediate values, registers, or specification of addressing modes, are all pushed on the data stack for the assembly command to consume and build the final machine code into the dictionary.

Table 3.5. 8086 Assembly Commands, Forth Style.

Assembly Command	Function
>NEXT #) JMP	Jump to address >NEXT.
1 # AX MOV	Move value 1 into AX register.
6 # RP ADD	Add 6 to the return stack pointer. Pop three 16 bit numbers off the return stack.
8000 # BX ADD	Add 8000 to the contents of BX.
0 [IP] DX MOV	Copy the contents of memory pointed to by IP into DX register.
0 [W] W MOV	Copy the memory pointed to by W register into W register.
PDO JNE	Jump to address PDO if the zero flag in status is not set.
REP BYTE MOVS	Move a range of bytes in memory. Source pointed to by SI, destination pointed to by DI, and count in DX.
0 [BX] POP	Pop data stack into memory pointed to by BX register.
CX PUSH	Push contents of CX on the data stack.
AX LODS	Move memory pointed to by IP into AX register and increment IP by 2.
SP RP XCHG	Exchange data and return stack pointers.

There are three return commands which assemble jump instructions to the inner interpreter which returns control of the CPU to the next command to be executed or to the text interpreter.

Table 3.6. Return Commands

NEXT	Assemble a jump to >NEXT routine so that the next word pointed to by the IP will be executed.
1PUSH	Assemble a jump to APUSH routine which pushes AX on data stack and then falls into >NEXT.
2PUSH	Assemble a jump to DPUSH routine which pushes DX on data stack and then falls into 1PUSH.

F83 uses a centralized return mechanism by which all code commands eventually execute the code routine at >NEXT, the inner interpreter. This single return point makes it possible to implement the powerful debugger which patches >NEXT to a debugging routine to single step through the execution sequence.

CODE generates executable machine instruction routines which behave the same externally as high level colon commands. The code routines are easy to test under the Forth operating system. However, to write a piece of code which can be shared by many code commands, it is necessary to build subroutines. The command to define subroutine is LABEL, which is similar to VARIABLE in the sense that it returns an address when invoked. This address can be used in other code

commands to assemble a CALL instruction doing the subroutine calling. A LABEL routine cannot be executed or tested directly. It can only be called inside a code command.

Within a code command, the execution path can be altered or repeated using structure commands IF-ELSE-THEN, BEGIN-UNTIL, and BEGIN-WHILE-REPEAT, similar to those used in colon commands. The principal difference is that the test conditions required by IF, UNTIL, and WHILE are not taken from the data stack but from the status register. These conditional commands must be preceded by machine code conditionals so that proper conditional branching instructions can be assembled. The machine code conditionals are listed in Table 3.7.

Table 3.7. Machine Code Conditionals

Forth Conditional	Assembled Code
0=	JNE/JNZ
0<>	JE/JZ
0<	JNS
0>=	JS
<	JNL/JGE
>=	JL/JNGE
<=	JNLE/JG
>	JLE/JNG
U<	JNB/JAE
U>=	JB/JNAE
U<=	JNBE/JA
U>	JS
OV	JNO

The Forth conditionals are reverse of the assembler code because the IF, UNTIL, and WHILE are skip-on-condition, not jump-on-condition as in the machine instructions. A machine instruction preceding the jump instruction sets the flags in the status register in 8086 CPU for the jump instruction to select the next instruction to be executed. An example of the branching structure in Forth style is:

```
5 # CX CMP 0< IF AX BX ADD ELSE AX BX SUB THEN
```

The structure commands IF, ELSE, etc., are different from those used in the colon commands. The assembler structure commands are in the ASSEMBLER vocabulary and those in colon commands are in the FORTH vocabulary. Their behaviors are quite different.

A very good example is the code command of UPPER which converts a string of ASCII characters to upper case characters:

```
CODE UPPER ( addr length -- )
  CX POP BX POP      Get parameters into registers.
  BEGIN              Setup the loop.
  CX CX OR            Is the count in CX zero?
  0<> WHILE           Exit the loop if CX is zero.
  0 [BX] AL MOV       Get one character to AL.
  >UPPER #) CALL      Call a subroutine to convert the character to upper case.
  AL 0 [BX] MOV       Put the converted character back into the string.
  BX INC              Address of the next character.
  CX DEC              Character count.
```

REPEAT	Convert the next character.
NEXT	Done. Return.
END-CODE	

CX CX OR sets up the status flag and 0<> WHILE sets up the conditional jump instruction to exit the loop. REPEAT assembles a jump instruction back to CX CX MOV to continue processing the next character until the character string is exhausted.

Code commands are difficult to debug and are machine dependent. They are defined only as the last resort to squeeze performance out of your computer and should not be considered lightly. In most programs, there are only a few critical commands which are executed very often. You should try to identify these commands and convert only these commands to code commands.

3.7. Multitasker

The early Forth systems implemented by Charles Moore were multi-tasking systems and could support many users or terminals to operate simultaneously. The implementers of figForth neglected this feature in the figForth Model. Because of the popularity of figForth, Forth has been regarded by most users as a system only suitable for single user without the multi-tasking capability. The Forth architecture was designed to be able to run many tasks at the same time. The authors of F83 restored this important feature of Forth to the F83 system without too much effort. The source code to put the multi-tasker back consumes only about six screens. Try to do it in PASCAL!

Commands to create one or more tasks are already defined in the FORTH vocabulary. A task must be first created by the command TASK:, which allocates space in the dictionary needed by a task, including area for user variables, return stack, and data stack. When the task is later activated by the command ACTIVATE, the task will execute a sequence of commands and share the CPU with the regular Forth system in a round robin task switching scheme. Each task uses the CPU until it voluntarily gives up by executing PAUSE or STOP and releases the CPU to the next task in the round robin chain. All system I/O commands have PAUSE's embedded to switch tasks automatically. In the command sequence give to a task to execute, the command PAUSE or STOP must be placed properly so that the task will not hold on to the CPU indefinitely.

Background tasks are defined by the command BACKGROUND: . Examples are:

```
BACKGROUND: SPOOLER 1 CAPACITY SHOW STOP ;
```

SPOOLER is defined as a background task which lists a complete screen file to the printer while you still have full control over the Forth computer via your keyboard.

Once the SPOOLER is defined as a task, it can be re-assigned to perform other chores. For

example:

```
: SPOOL-THIS SPOOLER ACTIVATE 3 15 [ SHADOW ] SHOW STOP ;
```

will print the screens 3 to 15 with their shadow screens in a six screens per page format.

Another example is to maintain a counter counting the cycles around the round-robin task switching loop. A global variable COUNTS is defined to keep the counts so that you can examine it any time you want to.

```
VARIABLE COUNTS  
BACKGROUND: COUNTER BEGIN PAUSE 1 COUNTS +! AGAIN ;
```

which increments the variable COUNTS indefinitely at the background. You can run the computer in the foreground, doing any thing you care to. Occasionally, you can read COUNTS to see how many times the computer runs around the task switching loop.

After background tasks are defined, the command MULTI starts the multi-tasker running. The command SINGLE stops the multi-tasker. Individual background tasks can be stopped or restarted by the following commands:

```
SPOOLER SLEEP ( Put spooler on hold.)  
SPOOLER WAKE ( Restart the spooler.)
```

The multi-tasker is fun to play with. You have to try it your self to appreciate it. Windows are built this way.

3.8. Save A System Image

Suppose you have developed an application using F83 and also found a company interested in buying this program from you. It would be nice if the user of this program can simply insert a disk into his drive, type a magic command, and have the entire program running immediately. He just wants to use the program and does not have any interest on how this thing is written or how it works. If you sell this program to the company, you may not want to reveal to them all the source code you developed so that they will short cut you. The best solution is to give them an executable object file which can be loaded into the computer and run, but very difficult to decipher and modify.

F83 gives you a tool to generate an executable object file from the dictionary of your running Forth system. When this object file is loaded into the memory through the operating system, it restores the computer to the same state as your current system. The command to do it is SAVE-SYSTEM:

```
SAVE-SYSTEM GISMO.COM
```

It copies the entire dictionary into a file named GISMO.COM. When you boot your system in DOS or CP/M, typing GISMO will load this file into memory and start the Forth system. Now, you can execute the highest level command in your application and run it.

3.9. The Metacompiler

Using SAVE-SYSTEM you make an object file with your application program overlay on the top of the F83 Forth system. It is fine this way if you allow the user open access to F83 system. However, allowing an unsophisticated user unlimited access to Forth can be disastrous for the health of his computer and to your profit. Another problem is that there is lots of code in the F83 system not needed by your application, but it is also saved in the object file doing nothing but occupying RAM space. The meta-compiler in F83 allows you to strip out the dead wood and build an application package best tailored to the application. It recompiles the entire Forth system with your application. During the compilation, you have the option to omit any command not needed by your application. If the target computer is not identical to the host computer you used to develop the application, you can also modify the source code in the kernel so that the application can be run on the target computer. The ability to generate a new Forth system from a Forth system is called metacompilation. Metacompilation is sometimes referred to as the 'extensibility of the third kind', which is the highest level of programming activity on a computer.

F83 system was itself generated by the metacompilation process, and all the source code needed for its self-generation are included in it. The command sequence to create the executable object image F83.COM is as follows:

1. Prepare a disk with F83.COM file on it. This F83.COM file is the Forth system which will do the metacompiling. Insert this disk into drive A.
2. Prepare a disk with METAnn.BLK and KERNELnn.BLK files on it. METAnn.BLK contains the metacompiler and KERNELnn.BLK contains source code for the bare-bone Forth system. Insert this disk into drive B.
3. Log on to drive B, and type the following command:

```
A:F83 METAnn.BLK
1 LOAD
```

F83 is now loaded and builds a bare-bone Forth system, which is stored on the disk in drive A with a name KERNEL.COM.

4. Type BYE to return to DOS or CP/M.
5. Copy KERNEL.COM to a new disk with three files EXTENDnn.BLK, CPUUnnnn.BLK, and UTILITY.BLK. Insert this disk in drive A.
6. Log onto drive A and type the following command:

```
KERNEL EXTENDnn.BLK
1 LOAD
```

All the extensions and utilities are now loaded and a new version of F83.COM is created on drive A.

7. Type BYE to return to DOS.

nn above stands for 80, 86, or 68 depending upon the host computer running the F83 system, and nnnn stands for 8080, 8086, or 68000.

The above procedure was used to generate the F83 system. If you want to modify the system and add your own programs to the system, you have to prepare the files and load them in a sequence similar to the above sequence. I must remind you that meta-compiler is very complicated because it has to compile the target code to a virtual memory space where the code cannot be executed. There are many important conditions which must be satisfied for a successful metacompilation, such as forward references, proper initialization of system variables, and the initialization of all the vectored execution routines. These subjects will be discussed in detail when we study the code in the meta-compiler. You have to understand the metacompiler fully before attempting your modifications.

Part II. The Forth Kernel

Chapter 4. Interface to the Host Computer

Source code discussed in this chapter is in the file KERNEL86.BLK, Screens 3 to 15.

4.1. Virtual Forth Computer

The Virtual Forth Computer is a program loaded into the memory of a real computer. It partitions the computer memory into areas of specific functionality and enables the real computer to process Forth command streams. Fig. 4.1 is a schematic representation of the functional parts in a Virtual Forth Computer. It consists of a dictionary, two stacks, a terminal input buffer, and a number of disk buffers. These are the essential parts in a Virtual Forth Computer.

The Virtual Forth Computer uses a set of registers to keep the most vital information and to control the execution sequences. They are:

SP	Data Stack Pointer
RP	Return Stack Pointer
IP	Interpretive Pointer
W	Current Word Pointer
PC	Program Counter

The program counter PC and the return stack pointer RP are usually registers in the host CPU. The data stack pointer SP, the interpretive pointer IP, and the current command pointer W can reside in CPU as registers or implemented in memory if the host CPU does not have enough registers.

The dictionary is a linked list of commands. Each command consists of five fields: The name field and the link field allow commands to be linked into a linear list which can be searched by the text interpreter for a command by its name. The code field contains the address of the inner interpreter for this command and the parameter field contains necessary information specific for the task defined for this command. The view field contains information on where the source code of the command is located on disk to help user in locating the source code and detailed documentation on the command.

Two stacks are needed by the Virtual Forth Computer. The return stack contains a list of addresses of commands which are waiting to be executed, or addresses to be returned to after procedure calls. It is similar to the return stacks used in most modern computers. The other

stack is called data stack, holding a list of numeric and logic parameters to be passed between commands. Separating numeric parameters and return addresses into two stacks allows procedure calls without passing parameters through explicitly parameter lists. It greatly simplifies the syntax of Forth and cuts down the overhead for procedure calls.

Buffers are used to reduce time and efforts to process data transferred between the Forth computer and the I/O devices. Since the two major I/O devices in a typical computer system is the disk for mass storage and the terminal for operator control, two buffer areas, a disk buffer area and a terminal input buffer, are allocated to handle the I/O data.

The kernel of the F83 system is the part of the dictionary which contains commands defined in the machine code of the host computer, and transforms the host computer into a Virtual Forth Computer so that the computer can accept and act upon Forth commands give to it either through a keyboard or through text loaded from a disk. It is the elementary Forth operating system, which can be expanded by loading utility programs and application programs, and then executing those programs.

4.2. Forth Computer Hosted on 8086

The Virtual Forth Computer is a hypothetical computer or an ideal structure of a computer which can process (interpret or compile) Forth command set. So far, we have yet to see a computer built based upon the Forth architecture. However, this architecture can be implemented on any CPU worthy of the name. As a matter of fact, most of the commercial CPU's have at least one version of Forth on them, including all popular microprocessors, minicomputers, and many mainframes. Because Forth is simple and relatively small, it can be implemented on a computer with about one man-month's effort. This is very short comparing to other operating systems or high level languages.

F83 has three versions: one for 8080, one for 8086/8088, and one for 68000. Because the very small number of registers are available in the 8080 CPU, many Forth registers will have to be simulated in memory. Most numbers processed in Forth are 16 or 32 bits in width. They have to be manipulated in 8 bit chunks in 8080. Forth code commands in 8080 machine instructions are thus very messy and very difficult to explain. Between 8086 and 68000, my personal preference is 68000 which has a much cleaner architecture and more orthogonal instruction set. Nevertheless, I feel very feeble in raising a voice against the infinite wisdom of IBM, who picked 8088 for PC. Since there are apparently more people using 8088 than 68000, it is better to write this manual in terms of the 8086/8088 F83 model if I want to sell more copies of this manual.

First of all, let see how the Forth registers are assigned in the 8086 CPU:

Table 4.1. 8086 Register Assignments for Forth

8086 Reg.	Forth Reg.	Function
AX	Acratch	Accumulator
CX	Scratch	Counter
DX	Scratch	I/O control
BX	W	Current word pointer
SP	SP	Data stack pointer
BP	RP	Return stack pointer
SI	IP	Instruction pointer
DI		Scratch
ES		Extra segment
CS		Code segment
SS		Stack segment
DS		Data segment

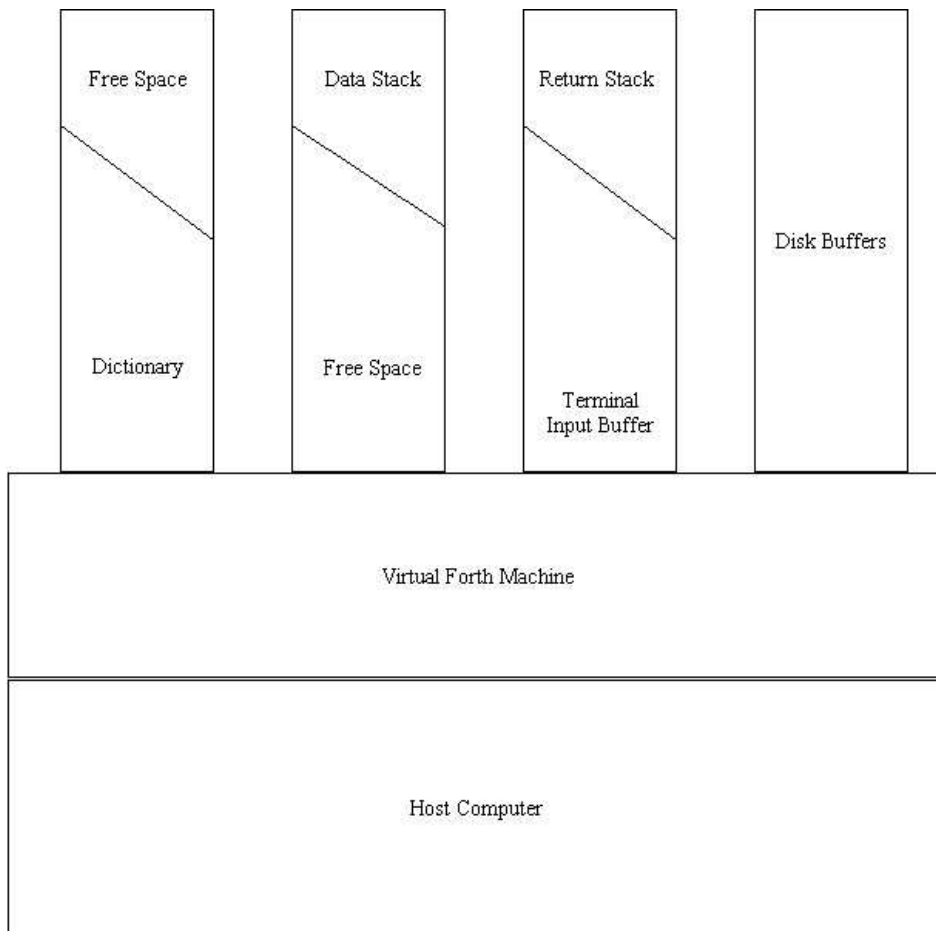

Figure 4.1 The Virtual Forth Computer

8086 has only one stack, with SP as stack pointer, which allows pushes and pops. Other registers do not have automatic incrementing or decrementing facilities, and increment/decrementing must

be done explicitly. An interesting exception is the SI index register. When SI is used in the supposed string instruction LODS and STOS, it is incremented by 1 or 2 bytes to point to the next string element. It is ideal for the interpretive pointer. The stack pointer SP is used to implement the Forth data stack, while the Forth return stack is simulated using the BP register. Popping and pushing on the return stack have to be done explicitly by incrementing and decrementing the BP register. The command pointer W is simulated by the BX register. Lacking automatic incrementing and decrementing facility, the W register has to be left pointing to the code field after NEXT. It has to be incremented in code so that it will point to the parameter field. We will have to use indirect JMP instructions through the code field to control the program flow.

Other 8086 registers, like AX, CX, DX, and DI, can be used freely in code routines. However, parameters and other information cannot be passed from one command to another through these registers. They have to be initialized appropriately before use, but they do not have to be restored before the end of a code command. The W register or the BX register contains the code field address of the command under execution. If this address is not needed in the code command, this register can be also used without restoring. The SP, RP, and IP registers, however, have to be restored to the original values if they have to be used in a code command.

All information in the F83 system is contained within a single 64K byte memory segment, and the four segment registers ES, CS, SS, and DS are initialized to the same segment. They can be changes to address other segments of memory, but must be restored before the end of a code command. F83 system does not use them.

Memory Map

RAM memory in the host computer, as used by the F83 system, is a contiguous 64 Kbytes of memory. Forth separates this memory space into a few regions, each dedicated to specific function. The lowest memory is used to hold the interrupt vectors which is used by the hardware to service external interrupts or software interrupts. Immediately above the vector region is the dictionary, holding all the executable codes of the commands. Above the dictionary is a free space for you to define new commands. On the top of the memory map is the region for disk buffers. F83 allocate 4 Kbytes for the buffers, enough to hold 4 blocks of data from/to the disk. Under the disk buffers is an area storing user variables which are essential parameters for the Forth system to work. Below the user area is the return stack, sharing its space with the terminal input buffer, which is used to store characters received from the terminal keyboard before processed by the text interpreter.

Below the terminal input buffer is the data stack, growing downward into the free memory space

above the dictionary. The space just above the dictionary are used to store temporary text data. We can identify a word buffer, a text buffer called PAD, an insert buffer and a delete buffer used by the text editor. A video buffer of 1 Kbytes is also assigned if the screen editor is invoked. These buffers float on the top of the dictionary, moving to higher memory as new commands are added to the dictionary. Data stored in them have to be used before new commands are defined.

Fig. 4.2. schematically shows the arrangement of various regions in a typical F83 Forth system. Most Forth system are arranged similarly.

4.3. Inner Interpreters

Inner interpreters in Forth are a set of execution procedures, usually in the machine code of the host computer, which execute various Forth commands by processing the information stored in their parameter fields. The address of such a procedure is stored in the code field of a command. Forth commands of the same class have the same address in their code fields. Two major inner interpreters are used to process code commands, defined by machine instructions, and colon commands, defined in terms of other existing Forth commands. Many other minor inner interpreters are used in F83 system to process constants, variables, user variables, and other types of data and structures.

Code Interpreters

Forth commands defined by host machine instructions are executed by one of two routines, EXECUTE or NEXT. EXECUTE can be used to start executing any Forth command, given that the code field address of the Forth command is placed on the data stack before calling EXECUTE. EXECUTE is a regular Forth command which can be executed interactively or called from the text interpreter. At the end of all code commands, there must be a jump to the machine routine labeled NEXT, which transfer control to execute the next command in the execution sequence. In F83, NEXT is centralized so that every command must return to it through a JMP instruction. NEXT assumes that the code field address of the next command to be executed is stored in the IP register.

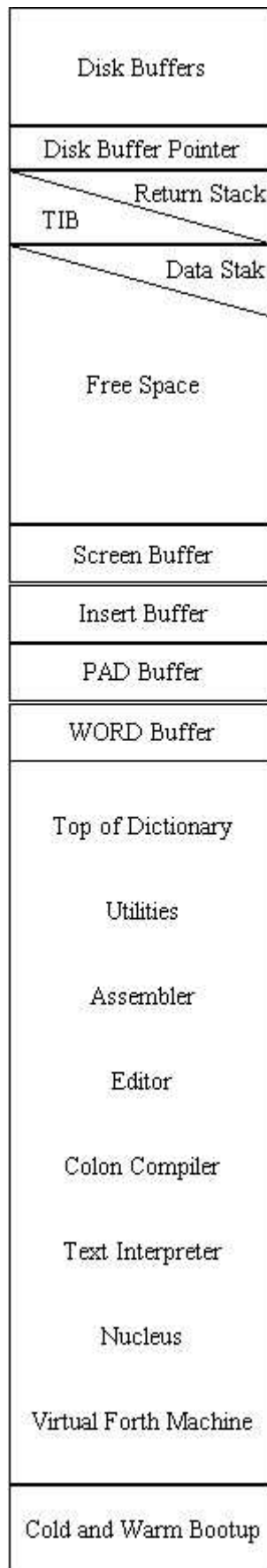

Figure 4.2 Memory map of F83 system

```

CODE EXECUTE ( cfa -- )      Execute the word whose execution address is on the data stack.
                                W POP          Pop execution address into W.
                                0 [W] JMP      Make an indirect jump through W. W is left pointing to the END-CODE
                                                code field. It must be incremented if parameter field must be
                                                addressed.
LABEL DPUSH                  A label in the target system.
                                DX PUSH        Push contents of DX on the data stack.
LABEL APUSH                  Another label.
                                AX PUSH        Push contents of AX on the data stack.
LABEL >NEXT                  The principal point of return for all code definitions. The
                                execution address of the next word to be executed in IP register.
                                AX LODS        Load the next execution address from IP into AX and increment IP.
                                AX W MOV       Copy execution address into W.
                                0 [W] JMP      Indirect jump through W.

```

The codes of EXECUTE appears in Screen 36 of META86.BLK, and the codes of NEXT is in Screen 25 in the F83 source. The fact that these codes are scattered in many separated blocks makes it difficult for the reader to put a whole picture together. It is the purpose of this manual to present you a well organized system description, and to help you understand the F83 model fully.

```

: NEXT                        A macro definition to assemble a jump to >NEXT instruction at the end of a code
                                definition.
>NEXT #) JMP                  Assembler the jump instruction.
;

: 2PUSH                       Another macro definition.
DPUSH #) JMP                  Jump to DPUSH, push DX on stack.
;

: 1PUSH                       Macro definition pushing AX on the data stack before NEXT.
APUSH #) JMP
;

```

These commands are defined in the metacompiler as shown in the source code. Let us not worry about them here.

Address Interpreter

The address interpreter is used to execute a high level Forth command whose parameter field contains a list of execution address. It processes this list by executing commands at these addresses sequentially.

The address interpreter is not an executable Forth command. It is a machine code routine labeled NEST:

```

LABEL NEST                    IP has the address to return and W has the code field address of the colon definition
                                to be called.
W INC W INC                   Increment W to point to the parameter field of the callee.
RP DEC RP DEC                 Decrement return stack pointer and prepare for a push.
IP 0 [IP] MOV                 Push contents of IP, the return address on the return stack.
W IP MOV                       Copy the first execution address into IP, to start the called colon definition.
NEXT                           Assembler >NEXT #) JMP here.

```

In 8086, W and RP have to be incremented twice because these registers are byte pointers. All

code routine ends up with the code >NEXT #) JMP. This is very convenient in debugging the system or changing the behavior of the code interpreter to include new features in the Forth system.

```
CODE EXIT          Terminate a colon definition and return to the caller routine whose address is
                   on top of the return stack.
0 [RP] IP MOV      Pop the return address back to the IP register.
RP INC  RP INC
NEXT              Return.

CODE UNNEST
' EXIT ' EXECUTE !
```

The standard command EXIT is vectored to UNNEST which is the reverse of NEST. NEST is equivalent to the high level subroutine call in FORTRAN, and UNNEST is the equivalent of RETURN.

Variable Interpreter

Variable interpreter uses the W register to point to the parameter field of the variable command and returns the parameter field address on the data stack for the subsequent commands to access the parameter field. This inner interpreter can be shared by other types of commands which uses the parameter fields to store various types of data, like strings, double integers, floating point numbers, or even large arrays. When a new command is created in the dictionary, the compiler assumes that the command is of this type, unless a new inner interpreter is defined. Instead of the old name DOVAR in figForth, F83 uses the generic name DOCREATE:

```
LABEL DOCREATE    W points to the code field.
W INC  W INC      Increment W to point to the parameter field.
W PUSH           Push pfa on the data stack.
NEXT            Return.
```

W register as returned by NEXT contains the code field address of the variable command. To get the parameter field address, W has to be incremented here. This is called the post-incrementing NEXT. In many other Forth systems, the W register is incremented inside NEXT so that it points to the parameter field at the end of NEXT. The pre-incrementing NEXT is more desirable than the post-incrementing NEXT, because the post-incrementing NEXT requires that the code field is two bytes ahead of the parameter field. Because F83 uses the W register to make the indirect jump to the inner interpreter, the W register cannot be incremented before the jump.

Constant Interpreter

Constant interpreter is very similar to variable interpreter. The only difference is that constant interpreter returns the contents of the parameter field while variable interpreter returns the address of the parameter field.

LABEL DOCONSTANT	W points to the code field.
W INC W INC	Point W to the parameter field.
0 [W] AX MOV	Fetch contents in the parameter field to AX register.
1PUSH JMP	Push AX on the data stack and then return.

The constant interpreter first copies the contents of the parameter field into the AX register, and then jumps to the APUSH routine which pushes AX on the data stack before falling into NEXT.

User Variable Interpreter

User variables are defined for a multitasking or multiuser Forth system. These variables are not addressed by their parameter field addresses, but by an offset into a memory area unique to the current user, a user variable area whose starting address is stored in a register or a variable UP. The user variables define the operating environment for a user at any point of its operation. Since each user has its own user variables preserved in a unique memory area, users or tasks can be switched very conveniently with minimal house keeping.

The user variable interpreter in F83 is defined as:

VARIABLE UP	The user area pointer is defined as a variable.
LABEL DOUSER-VARIABLE	
W INC W INC	Point W to the parameter field.
0 [W] AX MOV	Get the user area offset from the parameter field.
UP #) AX ADD	Add the offset to the base address in UP.
1PUSH	Push the address of the user variable on the data stack and return.

The parameter field of a user variable stores the offset value of the user variable in the user area. This offset value is added to the starting address of the user area as stored in the variable UP. The address returned on the data stack is the address of the user variable of the current user who is controlling the Forth system at this moment.

With all the viable system parameters saved in the user variable areas, the task switching in a Forth multitasking system is very easy and very efficient. The multitasker only has to save and restore the IP, RP, and SP in between two tasks. We will get into this in detail later. F83 has a very interesting multitasker which is a good demonstration of the power and the versatility of Forth as a system and as a language.

High Level Inner Interpreter

Inner interpreters are preferably coded in the host machine instructions, because they are the actual routines executed by the host computer. However, F83 does provide the CREATE ... DOES>

construct for users to define inner interpreters using high level Forth commands. These high level inner interpreters are easy to develop and eminently transportable across different host computers. The mechanism which allows this type of inner interpreters to execute correctly is DODOES:

```

LABEL DODOES           W points to the code field of the current words and SP points to the high level
                        inner interpreter.
SP RP XCHG
IP PUSH               Push current IP on the return stack.
SP RP XCHG
IP POP               Pop address of the high level interpreter into IP.
W INC W INC          Point W register to parameter field which may contain data.
W PUSH               Push W on the data stack.
NEXT                 Return to execute the high level interpreter while the top item on the data stack
                        points to the parameter field of the current word.

```

Using this DODOES, the new commands defined by the CREATE-DOES> structure is almost identical to those defined by the CREATE-;CODE structure. DODOES must be the first command to be executed in the high level inner interpreter.

Deferred Command Interpreter

F83 uses a special technique to handle forward references, which is normally not allowed in a regular Forth system. A deferred command is created with a blank parameter field. When the contents of the deferred command is finally compiled, the parameter field in the deferred command is then patched with a pointer pointing to the beginning of the compiled codes so that the deferred command can be executed. Before the contents of a deferred command is defined, however, the deferred command can be referred to by the compiler and be compiled as other regular commands even if it cannot be executed. This technique is useful, especially during metacompilation, where commands have to be referred before their functionality can be precisely defined by the commands compiled after them.

The deferred command interpreter fetches the address in the parameter field and makes an indirect jump through it:

```

LABEL DODEFER         Execute the word whose execution address is stored in the parameter field of this
                        deferred word.
W INC W INC          Get the parameter field address.
0 [W] W MOV          Replace W with contents of the parameter field.
0 [W] JMP            Make an indirect jump through it.

```

The deferred address can also be stored as a user variable so that each user may have its own version of the execution procedure to be referred to by the same name.

4.4. Interpreters for In-Line Data and Strings

In the parameter field of a colon command there is normally a list of execution addresses, which is

scanned sequentially by the address interpreter and executed. However, there are many instances that the execution sequence must be change in runtime or that some special data have to be included in-line with the execution addresses, like literal numbers and character strings. A set of special commands are defined to take care these conditions at runtime, when the colon command is being executed. Although these special commands are given names like other commands and can be found by both the text interpreter and the colon compiler, they are not meant to be invoked by either. They are compiled into colon commands by a corresponding set of immediate commands or compiler directives. To indicate their associations with corresponding compiler directive and that they are not to be directly invoked, they are assigned names with enclosing parentheses. Executing them interactively from a terminal is the most convenient way to crash a Forth system. Be warned of it!

```
CODE (LIT) ( -- n )    Push the contents in next cell on the data stack.
AX LODS                Load the contents of next cell, pointed to by IP, into AX. Increment IP to skip
                       over the numeric literal.
1PUSH                  Push the literal number on the data stack and return.
```

LODS is an interesting 8086 instruction. It is used to access character strings in memory using the SI register as a pointer. After the memory fetching, SI is automatically incremented. It happens that the SI register is the IP register in Forth virtual computer and the incrementing is exactly what we wanted in (LIT). It makes an extremely simple code command for (LIT). APUSH pushes the contents of AX register on the data stack before falling into the NEXT routine.

(LIT) thus overrides the natural tendency of the address interpreter to interpret data as execution addresses and forces the interpretation of the contents in the next cell as an in-line literal. This is the way literal numbers are compiled in a colon command, preceded by (LIT), so that in runtime, the number will be pushed on the stack and not to be mistaken for an execution address.

```
: (." ) ( -- )        Print the next character string to the terminal.
R>                    RP is pointing to the next cell where the string starts. Pop the string address
                       to data stack.
COUNT                Get the string address and character count on the stack.
2DUP + EVEN           Compute the address of the next executable word after the string.
>R                    Replace the next execution address back on the return stack.
TYPE ;                Now, type out the string.
```

(.) and the character string following it are compiled by the immediate command ." , in-line with the other execution addresses in a colon command. When the colon command is executed, (.) will pull this string out of the execution sequence, print it on the terminal, and then pass the control to the command after the string. This is the way we let a colon command print messages on the terminal to facilitate the user-computer interface. Computer can be made much more friendly this way if proper messages are printed timely.

```
: ( " ) ( -- addr n ) Leave the address and the character count of the following string on the stack
                       and continue execution after the string.
```

```
R> COUNT           Get the address and count on stack.
2DUP + EVEN       Compute the next executable word address,
>R ;              and put it back on the return stack.
```

(") is very similar to (.) in the way it handles the in-line string and the execution sequence. The difference between them is that (") leaves the string address and character count on the data stack without doing any terminal output; therefore, the string data can be manipulated any way we want in the colon command.

4.5. Interpreters for Control Structures

BRANCH and ?BRANCH

We all think Forth is a totally structured programming language, even saying: "Look Mom, no GOTO's!" GOTO's are replaced by structures like IF-ELSE-THEN , BEGIN-UNTIL , and DO-LOOP , etc. Well, the hard truth is that Forth does have GOTO's, disguised in names like BRANCH and ?BRANCH, and many other commands. If you learned how to use them, you could jump anywhere you wanted and create really messy spaghetti codes. Novices are made to believe Forth is GOTOless because they are shielded from the dark side of Forth.

BRANCH and ?BRANCH take the contents in the next cell as the address of the next executable command and direct the address interpreter to that address to start a new execution sequence. This can be done simply by manipulating the interpretive register IP.

```
CODE BRANCH ( -- )   Perform an unconditional jump to the address in the next cell.
LABEL BRANCH
0 [IP] IP MOV       Copy next cell into IP, thus
NEXT               effecting the branch.
END-CODE

CODE ?BRANCH ( f -- ) If the flag on stack is false, branch to the next address; otherwise, skip the
                    next cell and continue the execution sequence.
AX POP             Pop the flag into AX register.
AX AX OR           Set the CPU status register.
BRANCH JE         Branch if flag is false.
IP INC IP INC     Skip the jump address if flag is true.
NEXT
END-CODE
```

BRANCH is compiled by ELSE, REPEAT, and AGAIN. ?BRANCH is compiled by IF, WHILE, and UNTIL. The cell immediately following BRANCH or ?BRANCH is the address of the next executable command in memory, and it directs the conditional or unconditional branching, deviating from the normal sequential execution path favored by the address interpreter.

The New F83 Loops

The DO-LOOP structure experienced a major surgery in the birth of Forth-83 Standard, drastically

deviated from the DO-LOOP structure as Charles Moore invented. The basic reasons behind the new DO-LOOP structure were to eliminate the discontinuity of indexing through the 8000H boundary and to leave the loop immediately at LEAVE. F83 provides a solution by using three numbers on the return stack to handle the indexing and looping. The number at the bottom of the three is the address of the command right after LOOP, providing LEAVE with the return address to terminate the looping. The second number is the loop limit, offset by 8000H so that the index range from 0 to FFFFH becomes contiguous. The top number is the difference between the index and the limit, also offset by 8000H. At the end of the loop, LOOP increments the top number on the return stack by either one or the amount specified in the case of +LOOP, and tests for overflow from bit 14 to bit 15. The overflow condition occurs when the 8000H boundary is crossed from either direction. Therefore, both the positive and negative increments are handled correctly with a single run-time loop routine. Since the address of the command after LOOP is carried on the return stack, LEAVE can use this address to jump out of the loop.

```

CODE DO                Push the in-line exit address and the modified loop limit and scan range on the
( limit index -- )    return stack.
AX POP                Get the index.
BX POP                Get the limit.
LABEL PDO
RP DEC RP DEC        Make room on the return stack.
0 [IP] DX MOV         Get the in-line address following DO.
DX 0 [RP] MOV]        Push the exit address on the return stack.
IP INC IP INC        Pointing IP to the next executable word.
8000 # BX ADD         Offset the limit by 8000H.
RP DEC RP DEC        Make more room.
BX 0 [RP] MOV]        Push the modified limit on the return stack.
BX AX SUB             Subtract limit from index, also offset by 8000H.
RP DEC RP DEC        Make room.
AX 0 [RP] MOV        Push the index scan range on the return stack.
NEXT                 All done.
END-CODE

CODE (?DO)            Same as (DO) except that if index is the same as limit, the entire loop is skipped.
( lim ind --)
AX POP                Index.
BX POP                Limit.
AX AX CMP             Compare index and limit.
PDO JNE              If not equal, execute the loop.
0 [IP] IP MOV        If equal, jump over the do loop.
NEXT END-CODE

```

With the modified index, modified limit, and the exit address on the return stack, the task for end-of-loop routines are much easier. Believe it or not, this new loop structure is claimed to run faster than the old, traditional loop.

```

CODE (LOOP) ( -- )    Branch back to the executable word after DO if the index does not cross the 8000H
                      boundary. If it does, exit the loop after clearing the return stack.
1 # AX MOV            Increment by one. LABEL PLOOP Increment top of return stack,
AX 0 [RP] ADD         the scanning index.
BRAN1 JNO             If overflow condition is not set, jump to the in-line address compiled after (LOOP)
                      and repeat the loop.
6 # RP ADD            Pop all three numbers off the return stack. Clean up the return stack to the
                      state before the do-loop.
IP INC IP INC        Point IP to the next executable word. Exit the loop.
NEXT END-CODE

CODE (+LOOP) ( inc --) Increment the scanning index by the value on the data stack and decide whether
                      or not to loop.

```

```

AX POP          Get the increment.
PLOOP #) JMP   Use the same loop routine in (LOOP).
END-CODE

```

Since the scanning index on top of the return stack is not the index as we understood, the functions of I and J are also different.

```

CODE I ( -- index )   Return the current loop index.
0 [RP] AX MOV        Get the scanning index on top of the return stack.
2 [RP] AX ADD        Add the modified limit to the scanning index. The result is the actual current
                    index.
1PUSH                Push it on data stack.
END-CODE

CODE J ( -- index )   Return the loop index of the next outer loop in nested do-loops.
6 [RP] AX MOV        Get the outer index.
8 [RP] AX ADD        Add the outer limit.
1PUSH                Push the computed index on stack.
END-CODE

```

The New Leave

Forth-83 Standard requires that when LEAVE is executed inside a loop, the loop be exited immediately. It was agreed that the old LEAVE is not desirable in allowing execution to continue to the next LOOP before exiting the loop. Unwelcome guests should not be permitted to remain when the party is over. Since the exit address of the command after LOOP is compiled after (DO) and tucked on the return stack, LEAVE can be executed using this piece of information:

```

CODE (LEAVE) ( -- )   Immediately exit a DO-LOOP.
LABEL PLEAVE
4 # RP ADD           Pop the index and limit off the return stack.
0 [RP] IP MOV        Copy the exit address to IP, ready to exit the loop.
RP INC RP INC       Clear the return stack.
NEXT END-CODE

CODE (?LEAVE).( f -- ) Exit the loop immediately if the flag on stack is true. If not, continue the
                    looping.
AX POP              Get the flag.
AX AX OR            Test the flag for zero.
PLEAVE JNE         True. Leave the loop.
NEXT              False. Continue.
END-CODE

```

LEAVE is not very useful all by itself because it will defeat the purpose of a do-loop. In most cases, it is used after a testing condition like IF. ?LEAVE combines the functions of IF and LEAVE, and is a much more useful command.

Chapter 5. The Forth Nucleus

The source code discussed here is in the file KERNEL86.BLK, Screens 16 to 37.

In the last chapter on Virtual Forth Computer, what we discussed was the 'hardware' of this conceptual computer, such as the registers, the memory and its organization, buffers, and stacks. The inner interpreters are similar to the CPU in this computer, which cause the machine to perform the most primitive operations like jumping from one Forth Command to the next. There is also a 'software' part of the Virtual Forth Computer, i. e., the primitive command set or the elementary operations from which programs can be constructed to solve complex, real life programming problems. This primitive command set, the counter part of the microcodes or random logic machine instruction set in a real, conventional computer, is what we mean by the Forth Nucleus. In a real Forth computer, this instruction set will probably be microcoded or committed to random logic in the Forth CPU. Before that becomes a reality, the Forth Nucleus will have to be implemented on a real CPU using its native machine codes.

F83 is available in three versions: one for 8080, one for 8086/8088 and one for the more recent 68000. It's a pain to discuss the Forth nucleus in 8080 machine code, because we have to pretend that the 8 bit 8080 is a 16 bit machine. There is so much noise in the 8080 codes that you can hardly hear the beautiful music played in Forth. 8086 is far from being a dream machine. Being a 16 bit machine with more than enough registers in CPU, the Forth nucleus put on it looks much nicer and the code is considerably shorter. For most of the commands in the Forth nucleus, the 8086 code is less than 1 line in length and the functions are fairly obvious. In fact, most code is simple enough that I really don't have to go through them line by line, as I did for the inner interpreters. I will only go through the code by functional groups, making some occasional comments on special features in the F83 implementation.

I encourage you to read the code in the nucleus carefully because they are good examples of assembly programming in. There are lots of techniques and styles we can learn from these code. When you want to write code commands to take advantage of the speed and to tackle some hardware facilities, the best way is to pick up a code command in the nucleus of similar functions and modify it to suit your need. Once you are at home with the manipulation of stacks and the CPU registers in Forth assembly style, you will be able to build your own castles.

5.1. 8086 Assembly Language in Forth

Assembly code in Forth is quite different from the normal assembly code in conventional assembler.

The most eye catching difference is that the Forth assembly codes are written in reverse Polish notation, i.e., operands preceding the operator. The reason is simple. In Forth, the assembler is not a gigantic program which assembles mnemonic codes line by line. The assembly functions are scattered in many small pieces of Forth commands which are given assembly mnemonic names. When a Forth command like MOV is executed, it compiles a machine code to the dictionary where we are building the parameter field of a code command. When MOV is executed, it needs information like source register, destination register, and address mode. These information, or the operands, are provided on the data stack prior to the invocation of MOV. MOV takes the operand information from the data stack, does some computation to derive the correct machine code, and compiles this code to the top of the dictionary. All the other assembly commands do similar things, using data from the stack and compiling specific codes to the dictionary.

There is a major difference between the Forth colon compiler and the Forth assembler, even though they both build new commands on the dictionary. When compiling colon commands, the Forth computer is in the compiling mode, under which commands parsed out from the input stream are not executed, but have their addresses added to the dictionary. During assembly, the Forth computer is in the interpretive mode, under which all the assembly commands are executed. The net result produced by the execution of an assembly command is that a machine code is added to the dictionary. In other words, we can claim that it is the Forth text interpreter who does the assembly of machine codes. The full Forth system, with all its resources, are supporting the process to assemble machine codes. In a way, the assembly process is so much more complicated than compiling colon commands that it indeed needs the support of the whole Forth system. The complexity of the assembler is best seen in the actual codes of the Forth 8086 assembler, which will be the subject in a separated chapter. At this moment, we just have to learn how to read the Forth assembly code in the nucleus.

5.2. Code Definitions in Forth Nucleus

In the F83 Nucleus, all the code commands are written in the following general format:

```
CODE <name> < operands and assembly mnemonics > <end> END-CODE
```

A code command is enclosed between two commands CODE and END-CODE. Immediately following CODE is the name given to the command. After the name, there is a sequence of commands which are either assembly mnemonics or operands used by the mnemonics. The assembly mnemonics are Forth commands which assemble machine codes into the parameter field of the code command under construction. The command before END-CODE must be a special command which returns control to the routine which calls the command in runtime. Anywhere inside or outside of the code command, comments are placed between (or (S and), which are ignored by the Forth interpreter which does the assembly.

The assembly commands have mostly the same names as those mnemonics used in the regular 8086 assembler provided by Intel. However, they are not just names of machine instructions, they are actually Forth commands which assemble machine instructions into the dictionary when they are interpreted or executed. Many of these mnemonic commands require operands, which are supplied before the mnemonic commands. If two operands are needed, the format is:

```
<source operand> <destination operand> <mnemonics>
```

A partial list of the mnemonic commands is:

```
MOV PUSH POP JMP JE JNE JCXZ
ADD SUB MUL DIV AND OR XOR
MOVS PUSHF REPZ SAHF WAIT LODS XLAT
```

The following registers are defined in F83 for 8086:

```
AL CL DL BL AH CH DH BH
AX CX DX BX SP BP SI DI
ES CS SS DS
```

Forth registers RP, IP, and W are equivalent to BP, SI, and BX, respectively.

Several registers are often used for indirect addressing. The indirect addressing operands are the following:

```
[RP] [IP] [W] [SI] [DI] [BP] [BX]
```

An offset number must precede the indirect addressing operand. Numeric values needed as operands must be used with a numeric operator following immediately:

```
# #) S#)
```

where # is preceded by an immediate constant, #) is preceded by an address, and S#) is preceded by an address for intersegment jump.

Three most frequently used code endings are NEXT, 1PUSH, and 2PUSH. They are assembly macros which return control to the next command in the execution sequence. 1PUSH pushes the AX register on the stack before jumping into NEXT, and 2PUSH pushes first the DX register and then jumps to 1PUSH. Sometimes a JMP is used as a code ending. The routine jumped to must eventually fall into NEXT so that the execution can be continued.

5.3. Examples of Code Definitions

The following are a few simple examples of the code commands. They are fully commented here for the purpose of demonstrating the Forth assembly syntax. Since 8086 has most of the functions required by Forth in machine instructions, the code commands in the F83 nucleus are fairly simple and obvious. I will not try to make dumb comments any more.

```

CODE @ ( addr -- n )      Fetch a 16 bit value from addr.
BX POP                    Pop addr into BX register.
0 [BX] PUSH              Push the contents of addr, indexed by BX with 0 offset, onto the data stack.
NEXT                      Jump to next and return.
END-CODE                  End of code definition.

CODE !( n addr -- )      Store a 16 bit value at addr.
BX POP                    Pop addr to BX register.
0 [BX] POP                Pop n into memory at addr.
NEXT END-CODE

CODE C@ ( addr -- char ) Fetch an 8 bit value from addr.
BX POP                    Pop addr into BX register.
AX AX SUB                 Clear the 16 bit AX register.
0 [BX] AL MOV             Copy one byte at addr to AL.
1PUSH                     Push the byte value on stack and return.
END-CODE

CODE C! ( char addr -- ) Store an 8 bit value at addr.
BX POP                    Pop char into AX.
AX POP                    Store byte into addr.
AL 0 [BX] MOV
NEXT END-CODE

```

Other code commands in the nucleus are fairly straightforward and are also adequately commented in the shadow screens. They are grouped together and shown here for references. You are encouraged to read the detailed code and comments in the source listing.

Memory Commands

```
@      !      C@      C!      CMOVE      CMOVE>      FILL ERASE      BLANK      MOVE HERE PAD
```

Stack Commands

```
SP@  SP!  RP@  RP!  DROP  DUP  SWAP  OVER  TUCK  NIP
ROT  ROT  FLIP  ?DUP  R>  >R  R@  PICK  ROLL
```

Logic Commands

```
AND  OR  XOR  NOT  TRUE  FALSE  CSET  CRESET  CTOGGLE  ON  OFF
```

Arithmetic Commands

```
+  -  ABS  +!  2*  2/  U2/  8*  1+  2+
1-  2-  UM*  U*D  UM/MOD  *D  M/MOD  MU/MOD  *  /MOD
/  MOD  */MOD  */
```

Comparison Commands

```
0=  0<  0>  0<>  =  <>  ?NEGATE  U<  U>  <
>  MIN  MAX  BETWEEN  WITHIN
```

Double Integer Commands

2@ 2! 2DROP 2DUP 2SWAP 2OVER 3DUP 4DUP 2ROT D+
DNEGATE S>D DABS D2/ D- D0= D= DU< D< D> DMIN DMAX

String Commands

COUNT LENGTH -TRAILING UPPER COMP CAPS-COMP COMPARE

Chapter 6. Terminal Input and Output

The source code discussed in this chapter is in file KERNEL86.BLK, screens 41 to 49.

Forth is an interpretive language which intimately interacts with you through a CRT terminal. Terminal input and output control is a very important part of the Forth system, allowing you to enter commands and data into the computer and display the results or messages on the CRT. Many Forth implementations have input/output commands coded in the host machine codes which access the terminal directly. These Forth systems are often stand-alone systems which do not need support from a traditional operating system. F83 was designed to run under the popular CP/M or MS-DOS system, so that it can be transported between different host computers. The terminal input/output commands in F83 thus utilize the CP/M or DOS BIOS routines to receive information from the keyboard and send information to the CRT display.

6.1. The BIOS I/O Calls to the Operating System

The fundamental interface between Forth terminal I/O commands and the CP/M or DOS is the Forth command BDOS:

```
CODE BDOS          Load function code into C register and entry parameter into D register. Call the
( entry function -- BIOS. Return result are then pushed on the data stack.
return-value )
CX POP            Load function code into C register.
DX POP            Load entry parameter into D register.
33 INT           Call BIOS by a software interrupt. This is the MS-DOS interrupt vector. For CP/M,
                 it is 224 INT.
AH AH SUB        Clear the high byte in the AX register.
1PUSH            Return with the result on stack.
END-CODE
```

BDOS is not only used for terminal I/O, it can also be used for most of the disk I/O calls, making Forth I/O commands very neat and simple.

```
: (KEY?) ( -- f )   Return a true flag if the user presses a key. Otherwise, return a false flag.
0 11 BDOS          Function 11 is the direct console I/O call. Entry 0 specifies a console status
                 command. If no character is ready, 0 is returned. If a character is entered,
                 FFH is returned.
0<>              Reversed the BDOS flag.
;

: (KEY) ( -- char ) Wait until a key is pressed and return the ASCII code.
BEGIN            Enter the wait loop.
  PAUSE         Release the CPU to other tasks so that the multitasking scheme can work smoothly.
  (KEY?)       Is a key pressed?
UNTIL          Yes, then exit the loop. Otherwise, wait another round.
0 8 BDOS       Entry parameter 0 specifies a console input function and returns an ASCII code
                 on the stack.
;

: (CONSOLE) ( char -- ) Send the character on stack to the terminal for display.
PAUSE          Let other task have a run on the CPU.
6 BDOS        Call BDOS to send out the character.
```

```

DROP                BDOS always returns a number on the stack. It has to be dropped.
1 #OUT +!          Increment user variable #OUT, keeping track of the output character count.
;

: (PRINT) ( char -- ) Send a character to the printer.
PAUSE              Always pause before an I/O operation because I/O operations are generally slow.
                  CPU can then be freed to serve other tasks or other users.

5 BDOS             Function 5 is the BDOS call for output to listing device.
DROP              Clear the stack.
1 #OUT +!          Increment #OUT.
;

: (EMIT) ( char -- ) Send the character to both the terminal and the printer.
PRINTING @        Is the printing flag set?
IF                Yes. Sent character to the printer.
  DUP (PRINT)      Print character.
  -1 #OUT +!       Back up #OUT so it will not be incremented twice
.THEN
(CONSOLE)         Output to the terminal.
;

```

(KEY?), (KEY), and (EMIT) are the actual commands vectored to by KEY?, KEY, and EMIT. EMIT can be vectored to (PRINT) or (EMIT) like the regular CP/M system to activate the printer with the console.

6.2. Terminal Output Commands

The following output commands are all simple derivatives of EMIT and they do not need extensive comments:

```

: CRLF ( -- )      Send a carriage return and a line feed to the console.
3 EMIT            Carriage return.
10 EMIT           Line feed.
#OUT OFF          Clear the output character count.
1 #LINE +!        Increment the line count.
;

: TYPE ( addr len -- ) Display a string on the console.
0 ?DO            Repeat len times, but skip if len is zero.
  DUP C@ EMIT    Send one character.
  1+             Increment character address.
LOOP
DROP            Clear stack.
;

: SPACE ( -- )     Send a space to console.
BL EMIT ;

: SPACES ( n -- ) Send n spaces to console.
0 MAX           Eliminate negative counts.
0 ?DO          Repeat n times.
  SPACE
LOOP ;

: BACKSPACES ( n -- ) Send n backspaces to console.
0 ?DO
  BS EMIT
LOOP ;

```

6.3. Interpreting Control Characters

Forth is capable of using most of the ASCII characters for command names. Only a few ASCII

codes are reserved for system functions. Many figForth systems reserve the NUL (ASCII 0), CR (ASCII 13), and SP (ASCII 32) as delimiters for Forth commands. The DEL (ASCII 127) is used to nullify the previously entered character, which is important in correcting typing errors. Other non-printable characters or control characters can be used freely to name commands. Because it is difficult to document the non-printable characters, embedding them in names is discouraged unless you want a very secured environment.

F83, on the other hand, provides a mechanism for you to implement special functions for control characters. When a function is defined for a particular control character, the function will be executed immediately when that character is entered on the keyboard. A jump table is maintained for all the 32 control characters. A few of them are used for special purposes which are defined as follows:

```

: BS-IN ( n char -- n-1 )  Back up the input character buffer by dropping the character off the stack and
                           decrementing n by 1.  If n is zero, sound the bell instead.
  DROP                    Discard the character.
  DUP IF                  Is n=0?
  1- BS                   Yes.  Decrement n and backspace.
  ELSE
  BELL                    n=0.  Sound the bell.
  THEN EMIT              Send either BS or BELL to console.
;

: (DEL-IN) ( n char -- n-1 )  Backup the input and erase the previous character.  If n=0, sound the bell.
  DROP
  DUP IF
  1- BS                   Backspace.
  SPACE BS                Send a space and backspace again.  Erase the previous character.
  ELSE BELL
  THEN EMIT ;

: BACK-UP ( n char -- 0 )  Erase the current line and set the character count to zero.
  DROP                    Discard the character on stack.
  DUP BACKSPACES          Backup to the beginning of the current line.
  DUP SPACES              Erase all the characters on this line.
  BACKSPACES              Backup
  0                        Clear character count.
;

: RES-IN ( char -- )  Reset the Forth system to a clean start again.
  FORTH                    Set default vocabulary.
  TRUE                     Force system abort.
  ABORT" Reset"           Abort with a message.
;

: P-IN ( char -- )  Toggle the printer on or off.
  DROP PRINTING @        Get the flag in PRINTING.
  NOT                      Complement it to turn the printer on or off.
  PRINTING !              Store it back.
;

: CR-IN ( m addr n char -- m addr m )  Finish input and remember the number of characters in SPAN.
  DROP SPAN !            Store n in SPAN.
  OVER                    Duplicate m.
  BL EMIT                 Send out a space.
;

: (CHAR) ( addr n char -- addr n+1 )  Process a normal character by appending it to the input buffer.
  3DUP EMIT              Send character to console.
  +                        Addr+n, the memory address for the current character.
  !                        Store the character into the input buffer at addr+n.

```

```

1+          Increment n by 1 for the next character.
;

DEFER CHAR          CHAR will be vectored to (CHAR).
DEFER DEL-IN       DEL-IN will be vectored to (DEL-IN).
VARIABLE CC        CC will be used to point to the current control character table.
CREATE CC-FORTH    The control character table which can handle each control character as a special
                  case. It is actually an execution array which is indexed into by EXPECT to do
                  the right thing when it receives a control character.
]                Enter compilation mode to compile 32 execution address for the 32 control
                characters.
CHAR CHAR CHAR CHAR CHAR CHAR CHAR CHAR
BS-IN CHAR CHAR CHAR CHAR CHAR CR-IN CHAR CHAR
P-IN CHAR CHAR CHAR CHAR BACK-UP CHAR CHAR
BACK-UP CHAR RES-IN CHAR CHAR CHAR CHAR CHAR
[                Reenter the execution mode.

```

6.4. More Sophisticated Input Commands

KEY is the most elementary command to accept keyboard input. It simply gets a character and puts its ASCII code up on the data stack, not a very intelligent command. Once we have the control character table, we can build a very intelligent input command which can respond to many control characters to do a wide range of different things in response to our keyboard strokes. This command is EXPECT:

```

: EXPECT ( addr len -- )  Get a string from the terminal and place it in the buffer at addr specified.
                          Perform a limited amount of line editing. Save the number of characters input
                          in the variable SPAN. Process control characters as specified by the control
                          character table pointed to by CC.
                          Save len in SPAN.
DUP SPAN !
SWAP 0
BEGIN
  2 PICK
  OVER -
  WHILE
    KEY
    DUP BL <
    IF
      DUP 2*
      CC @ +
      PERFORM
    ELSE
      DUP 127 =
      IF DEL-IN
      ELSE CHAR
      THEN
    THEN
  REPEAT
  2DROP DROP
;

: TIB ( -- addr )        Get the address of the terminal input buffer.
                          'TIB @
                          TIB is vectored through 'TIB.
;

: QUERY ( -- )           Get an input stream of text from the terminal and store it in the terminal input
                          buffer. Prepare the system to interpret this input text.
                          TIB 80 EXPECT
                          .SPAN @
                          #TIB !
                          BLK OFF
                          >IN OFF
;

```

QUERY is the Forth input command at the highest level. It waits on you to type a line of text on the keyboard. The line is terminated either by receiving 80 characters from the keyboard or by receiving a carriage return key. The line of text is stored in the terminal input buffer. All the pertinent parameters are set so that the text interpreter can take over and interpret or execute the commands given in the input line.

6.5. String Commands

Screens 41 to 43 are a set of commands to operate on strings in memory. A string in Forth is a sequence of ASCII characters preceded by a byte count. A string may have zero to 255 characters. It is generally identified by the address of the count byte. However, most string commands require the address of the first character in the string as argument, not the address of the count byte. String commands use the following generalized syntax:

```
<source addr> <dest addr> <length> <string command>
```

Destination address is optional in cases of single string operations.

Most of the string commands are standard Forth-83 commands and their commands are simple and straightforward. I will only list here their functions and stack parameters:

Table 6.1. String Commands

Command	Stack Effects	Function
COUNT	(addr -- addr+1 len)	Convert the string address to address-length representation.
LENGTH	(addr -- addr+2 len)	Return address-length for long strings whose character count is 16-bits.
FILL	(addr len char --)	Initialize a string to char.
ERASE	(addr len --)	Initialize a string to NUL.
BLANK	(addr len --)	Initialize a string to blanks.
MOVE	(sour dest len --)	Move a string without overlapping.
UPC	(char -- char')	Convert a character to upper case.
UPPER	(addr len --)	Convert s string to upper case.
-TRAILING	(addr len -- addr len')	Delete trailing blanks from a string by changing its length.
COMP	(sour dest len -- n)	Compare source string with destination string. Return -1 if source<destination. Return 1 if source>destination. Return 0 if strings are the same.
CAPS-COMP	(sour dest len -- n)	Compare two strings regardless of character cases.
COMPARE	(sour dest len -- n)	Compare two strings. If CAPS is true, convert to upper case before comparing.

Short String

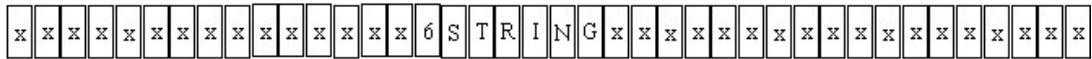

Long String



NUL String

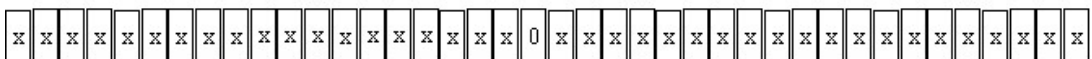

Figure 6.1 Representation of strings

Chapter 7. The Virtual Memory

The source code discussed in this chapter is in KERNEL86.BLK, Screens 50 to 56.

7.1. Mass Storage and Virtual Memory

Mass storage is a very important and integral part of a computer although we often think of it as a peripheral or an appendage. The computer uses the RAM memory for most of its normal operations, executing programs stored in RAM and operating on data stored in RAM. However, programs and data must be saved to more permanent and less expensive media before the power to the computer is turned off, or to transfer programs or data from one computer to another. Without mass storage, a computer is just as useful as a video game, operating entirely from the ROM memory with very limited amount of RAM. Most programming languages, by default or by neglect, do not include facilities to deal with the mass storage as part of the language. Thus we have to have a huge beast, an operating system, underneath the language to supply the functions necessary to use the mass storage conveniently and effectively.

Charles Moore perceived the need to use mass storage efficiently, to make Forth not only as a programming language, but also as a total environment in which you can describe and solve your programming problems. At the time he put together Forth, core memory was much more expensive than now and its use had to be optimized at all costs. His design used the mass storage, whether tape or disk, as a direct extension of the core memory. The user can address the mass storage in the same way he addresses the core memory, without worrying the detailed processes in storing data to disk or retrieving data from disk. This is the concept of 'virtual memory'.

The way how virtual memory operates is as follows. The mass storage, tape or disk, are divided into consecutive blocks as the basic storage units, each block consisting of 1024 bytes. The blocks are numbered from 0 to the capacity of the device, and are addressed by the block number. In the core or the RAM memory in the computer, an area called disk buffer is reserved as temporary storage for blocks of data from disk. One disk buffer is also of 1024 bytes and one or more disk buffers can be reserved. When a block of data is needed, it is read from the disk and stored in one of the disk buffers. Data in this disk buffer can then be used or modified, as needed by the program. When all disk buffers are filled and the system needs to read another block, the system will select the least used disk buffer to receive the new block of data. If the data in the selected disk buffer was modified by the program and was marked as 'updated', the contents of this buffer will be written back to the disk before the new block is read in. This way, the data on disk are assured of their integrity and constantly updated as required, while a few disk buffers can fulfill

the need to gain access to the entire disk without large overhead.

If you know how to read and write a sector of the disk, it is not a big job to implement the virtual memory system in Forth. Many Forth systems include such functions. These Forth systems have no need for an operating system because the functions of an operating system, handling terminal I/O and managing mass storage, are all provided by the Forth system. In this sense, Forth is its own operating system. F83 on the other hand was designed to run under the CP/M or MS-DOS system and uses the file system in CP/M for mass storage. The advantage is that the resulting Forth system can be easily transported from one computer to another, under the umbrella of CP/M or DOS, and that data can be dealt with within a more manageable file system. The disadvantage is that one cannot address disk at the sector level and the performance is degraded.

7.2. Disk Buffers

A set of pointers and constants are needed to construct the virtual memory system in allocating the disk buffers and defining their characteristics:

```
0 CONSTANT FIRST           The starting address of the disk buffers. The actual address is patched during
                             Forth initialization.
0 CONSTANT LIMIT           The address above the top disk buffer. Also patched at initialization.
4 CONSTANT #BUFFERS        Four disk buffers are allocated in this example.
1024 CONSTANT B/BUF         1024 bytes per disk buffer.
128 CONSTANT B/REC         128 bytes per record in CP/M and DOS.
8 CONSTANT REC/BLK         8 records per block of 1024 bytes.
42 CONSTANT B/FCB          44 bytes in a file control block
VARIABLE DISK-ERROR        Storing error code after a disk operation.
#BUFFERS 1+ 8 * 2+         The size of a buffer-pointer array. Each disk buffer uses 8 bytes in this array
CONSTANT >SIZE              to store buffer information:
                             0-1 Block number
                             2-3 Pointer to file
                             4-5 Buffer address
                             6-7 Update flag
```

This disk buffer pointer array is reserved just below the first disk buffer or FIRST. Whenever a block is referenced, its pointer is moved to the head of this array, so that the most recently used buffer is always checked first. This allows the references to multiple disk buffers to be very fast. Disk buffers are 1024 bytes long. No trailing zeros are needed to stop the text interpreter, as in figForth, because the text interpreter in F83 will process only 1024 characters in a buffer. The following commands are defined to get pointers to address into this array:

```
: >BUFFERS ( -- addr ) Return the address of the first buffer pointer.
FIRST                Starting address of first buffer.
>SIZE                Total bytes in the pointer array.
-                    First buffer pointer entry.
;

: >END ( -- addr )   Return the address of the last cell in the buffer pointer array
.FIRST 2-            One cell below FIRST.
;

: BUFFER# ( n -- addr ) Return the address of the nth buffer pointer.
8*                   Offset of the nth buffer pointer.
```

>BUFFERS
+

Origin of the buffer pointer array.
;

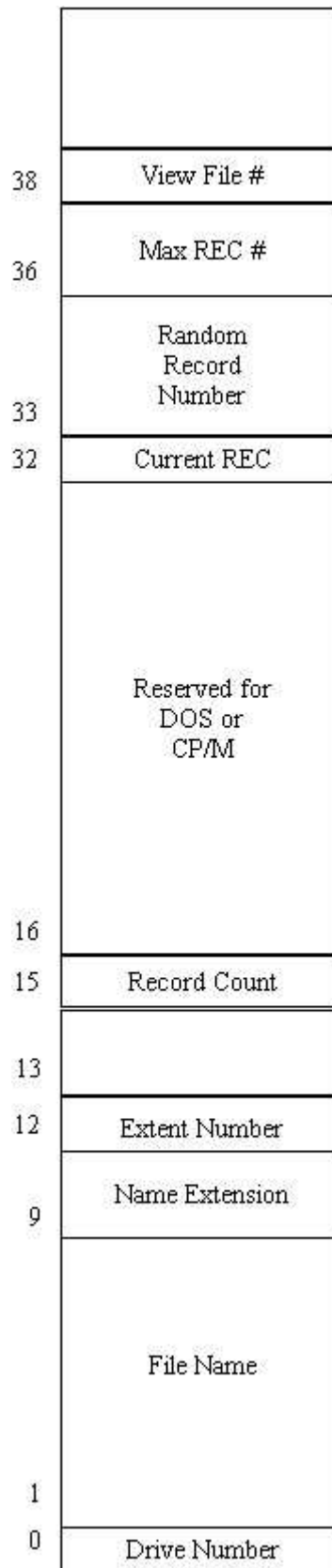

Figure 7.1 The File Control Block

7.3. The File Control Block (FCB)

CP/M-DOS programs access the disk files through BDOS calls. However, a program must maintain a special memory array which contains all the information about the file it is using. This memory array is called FCB, File Control Block, usually 36 bytes in length. The first byte in FCB stores the disk drive code. The next 11 bytes store the file name and extension. Bytes 33, 34, and 35 store the current random record number in read/write operation. F83 reserves 8 more bytes at the end of FCB for some special purposes. A user variable named FILE is used to store the address of the FCB currently used by the Forth system and indicates the current file. All other Forth commands doing disk I/O refer to the file pointed to by this user variable FILE.

To fully understand the structure of CP/M-DOS files and how they are utilized by programs is beyond the scope of this book. You have to go back to the CP/M manuals where these topics are treated in details. What I shall do here is to go through the F83 disk I/O commands and explain their functions. We only have to know a small portion of the CP/M to get a working knowledge of the CP/M-DOS files as required by the F83 system.

```
CREATE FCB1 B/FCB ALLOT   Create a default file control block in the Nucleus of F83. 41 bytes are reserved.

: CLR-FCB ( fcb -- )      Initialize the current FCB, given the address of the current File Control Block.
  DUP B/FCB ERASE         Clear the entire array to zero.
  1+                      Address of the first byte of the file name.
  11 BLANK                Initialize the name and extension to blanks, as required by CP/M.
;

: SET-DMA ( addr -- )     Set direct memory transfer address.
  26 BDOS DROP           A standard BDOS call.
;

: RECORD# ( fcb --
  addr )                 Return the address of the 3 byte pointer to the current random record.
  33 +                   Offset to the random record pointer.
;

: MAXREC# ( fcb --
  addr )                 Return the address of the field storing maximum record number in the current FCB.
  38 + ;

: VIEW# ( fcb -- addr )  Return the address where the file number for viewing is stored.
  .40 + ;
: CAPACITY ( -- n )      Return the number of blocks in the current file.
  FILE @                 Fcb of current file.
  MAXREC# @              Get the maximum record number.
  1+                      0 Make it a double number.
  8 UM/MOD               Unsigned mixed division.
  NIP                    Discard the remainder.
;

VARIABLE DISK-ERROR      A variable storing the record number out-of-range flag.

: IN-RANGE ( fcb --
  fcb )                 Make sure that the current random record is within range. Abort if it is not.
  DUP MAXREC# @          Maximum record in the file.
  OVER RECORD# @         Current record number.
  U<                     Do an unsigned comparison.
  DUP DISK-ERROR !      Store the flag in DISK-ERROR# for diagnostics.
  IF 1                   Error process.
  BUFFER# ON             Set buffer flag.
```

```

." Out of Range"
DISK-ABORT      Abort if out of range.
THEN           ;

```

7.4. Read and Write Disk Files

The following commands are the fundamental interface to the disk drive through the CP/M-DOS BDOS. They specify the disk drive, the memory address, the sector to be read or written, and do the reading or writing.

```

: REC-READ ( fcb -- ) Read one record from the current file. The record number is stored in the field
of random record.
DUP IN-RANGE      Check the random record number.
33 BDOS          Call the read random function.
?DISK-ERROR      Store the returned error code in DISK-ERROR.
;

: REC-WRITE ( -- ) Write one random record.
DUP IN-RANGE      Check the random record number.
34 BDOS          Write the record from memory.
?DISK-ERROR      Store error code.
;

```

One CP/M record is 128 bytes long. One Forth block is 1024 bytes long. To read or write one Forth block, we have to do eight consecutive reads or writes. Another thing we have to take care of is that there are four disk buffers allocated in the F83 system. The buffer to be used for disk I/O has to be specified by a pointer to the appropriate entry in the disk buffer pointer array in front of the buffer area.

```

DEFER READ-BLOCK      Vectored to FILE-READ.
DEFER WRITE-BLOCK     Vectored to FILE-WRITE.

: SET-IO              ( buffer-pointer-entry -- buffer rec/blk 0 )
Set up common parameters for file reads or writes.
DUP 2@               Get the block number, the first cell in a buffer pointer entry.
REC/BLK *            The record number.
OVER RECORD# !      Use it as the random record number. Put it in the FCB.
SWAP 4 + @          Get the address of the disk buffer in the third cell or the buffer pointer entry.
REC/BLK 0           These two parameters are the index and limit for read/write do-loops in FILE-READ
and FILE-WRITE.
;

: FILE-READ           ( buffer-pointer-entry -- )
Read 1024 bytes from current file to the disk buffer specified on stack.
SET-IO              Set random record number and leave buffer address and loop parameters on the
stack.
DO                  Repeat 8 times.
2DUP SET-DMA       Address for one record.
DUP REC-READ       Read one record.
1 SWAP RECORD# +! Increment the random record number for the next read
B/REC +           Address of next buffer area.
LOOP
2DROP             Discard the addr on stack.
;

: FILE-WRITE          ( buffer-pointer-entry -- )
Write a block to file.
SET-IO              Get buffer address and loop parameters.
DO                  Repeat 8 times.
2DUP SET-DMA       Record address.
. DUP REC-WRITE    Write one record.
. 1 SWAP RECORD# +! Next random record.
. B/REC +         Address of next buffer area.

```

```

LOOP
2DROP ;

: FILE-IO ( -- )      Vector block I/O words to file /O words to use CP/M files.
['] FILE-READ        Get the address of FILE-READ.
IS READ-BLOCK        Vector READ-BLOCK to it.
['] FILE-WRITE        Get address of FILE-WRITE.
IS WRITE-BLOCK        Vector WRITE-BLOCK.
;

```

7.5. Disk Buffer Management

The above set of commands allow us to access files on disk. As mentioned earlier, F83 maintains 4 disk buffers in its memory. How are these buffers used? Who decides which buffer is given to which block? When does the block on disk get updated? These are problems we have to face in using a virtual memory system projected into a file system. The following commands are designed to deal with these problems. We might call them the 'Virtual Memory Management' in F83 system.

Let's review what we know about the virtual memory in F83. There are 4 disk buffers, each 1024 byte long. There is a buffer pointer array with 4 entries, each entry being 8 bytes long. Each entry has four cells containing the block number, the pointer to a file, the buffer address, and the update flag. This array has all the management information on the disk buffers, while the buffers contain the actual data from/to disk file.

The buffer pointer array is a prioritized structure, in which the first entry points to the most recently used buffer and the last entry points to the least recently used buffer. When a file block is requested, this array is searched. If the disk block is in one of the buffers, its pointer entry is moved to the head of the array. If the disk block is not in the buffers, then the buffer pointed to by the last pointer entry is assigned to the new disk block. However, if the contents of this buffers was modified and the pointer entry was marked as updated, this buffer will be written back to the disk file before the new disk block is read into this buffer. Thus the disk file is maintained to reflect the current state of any update and modifications, while disk read/write is kept to a minimum. The disk I/O activities are totally transparent to you, as long as you use the commands BLOCK or BUFFER to access his file.

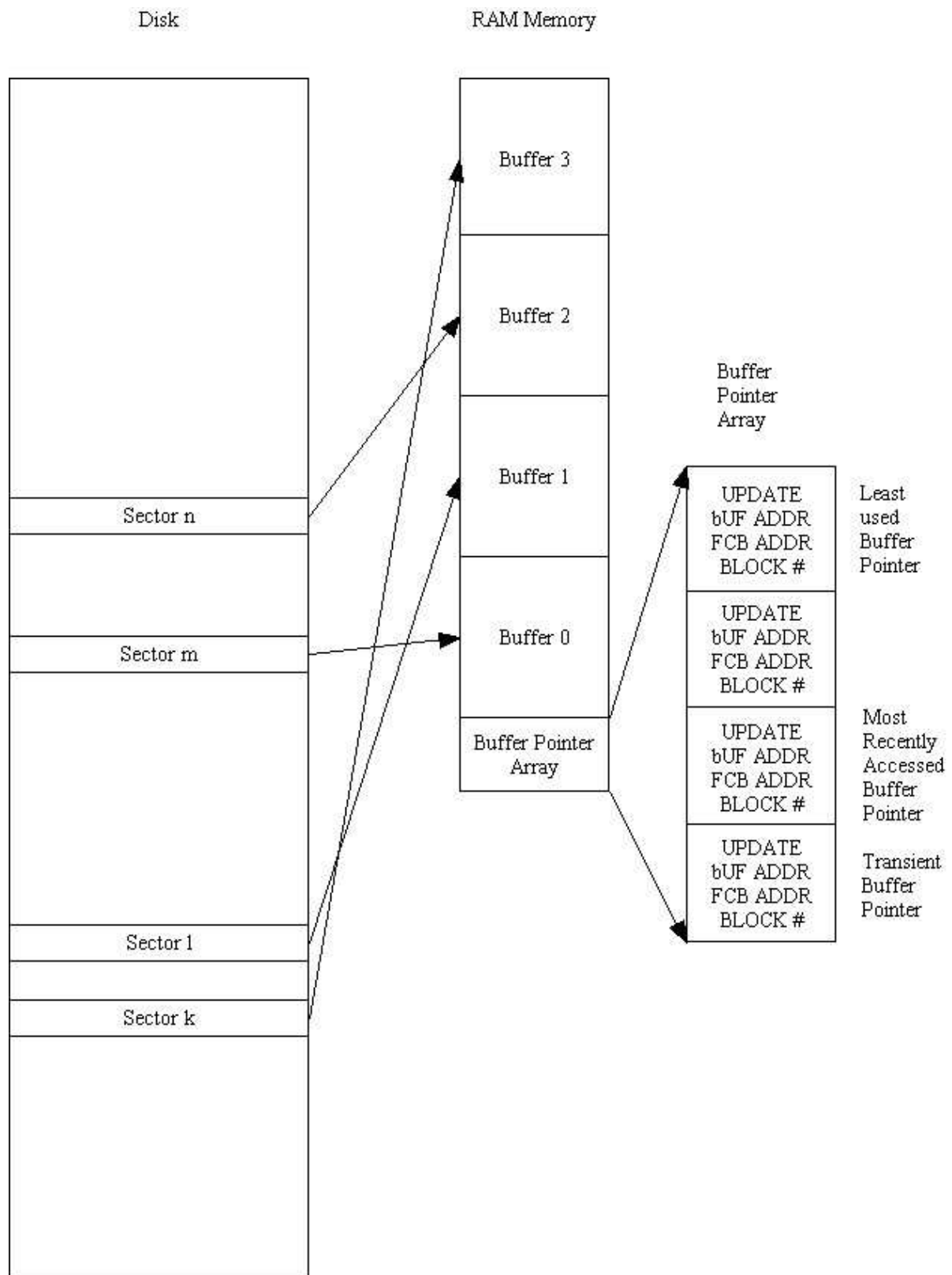

Figure 7.2 Disk buffer management

: LATEST?

(n fcb -- fcb n | addr f)

Check if block n is the first entry in the buffer pointer array. If it is, return the buffer address and a false flag, and exit from the calling word ABSENT?. If

```

DISK-ERROR OFF      not, return the block number n with the file control block address.
SWAP OFFSET @ +    First reset the error flag.
2DUP                Add the offset block number to obtain the true block number in the file.
1 BUFFER#          Leave a copy for return.
2@                 The first entry in the pointer array.
D= IF              Get the FCB address and the block number of the buffer pointed to by the first
2DROP              entry.
1 BUFFER#          If block n is pointed to by the first entry,
4 + @              Drop n and fcb. They are not needed.
FALSE              Get the address of the entry again.
R> DROP            Get the address of the disk buffer.
                    Push a false flag on top.
                    Discard the top address on the return stack and terminate the calling word ABSENT?.
                    The disk buffer was found and there's no point to search through the pointer array.
THEN               Block n is not the first entry.
;                  Return with the block number intact.

```

The most recently referred block is also the block most likely to be referred to the next time. LATEST? thus will cut down much buffer searching overhead and improve significantly the performance of the disk buffer management system.

```

: ABSENT?          ( n fcb -- addr flag )
                    Search through the buffer pointer array for block n in the current file. If it
                    is found, bring the buffer entry to the head of the array and return the buffer
                    address with a false flag. If block n is not found in the array, return a dummy
                    address with a true flag.
LATEST?            Is block n same as the first entry in the buffer pointer array? Exit if so.
                    Otherwise continue.
FALSE              Put a false flag on the data stack as the initial flag before looping.
#BUFFERS 1+ 2 DO   Scan through the buffer pointer array.
  DROP 2DUP        Get the block number n and fcb address duplicated
  I BUFFER# 2@     Get the n and fcb in the pointer array.
  D= IF            Is the block number and fcb match?
  2DROP I LEAVE    Yes. Block n is in a buffer. Leave the loop immediately.
  ELSE FALSE THEN  No match. Put a false flag back.
LOOP
?DUP IF            If a buffer is found to contain the required block, do the following:
  BUFFER# DUP      Address of the pointer entry found.
  >BUFFERS         Starting address of the pointer arrays or the 0th entry
  . 8 CMOVE        Copy this entry to the 0th entry.
  >R               Save the address of entry found.
  >BUFFERS         Address of 0th entry.
  DUP 8 +          Address of 1st entry.
  OVER R> SWAP     Current entry address.
  -                Length of entries to be shifted downward by 8 bytes.
  CMOVE>           This shift brings the entry with block n to the 1st entry, making it the currently
                    used buffer.
  1 BUFFER#        Address of the 1st entry with block n just found and moved to he 1st entry.
  4 + @            Get its block buffer address.
  FALSE            Put the 'found' flag on data stack.
ELSE               No match. The requested block is not in any of the disk buffers.
  >BUFFERS 2!      Store the block number and fcb in the 0th pointer entry
  TRUE             Return with a 'not found' flag.
THEN               ;
: >UPDATE ( -- addr ) Get the address of the update field in the 1st buffer pointer entry.
1 BUFFER# 6 + ;

: UPDATE ( -- )      Mark the most recently used buffer as modified.
>UPDATE             Address of the update field in the 1st entry.
ON                  Set it true to indicate that the buffer is modified.
;

: DISCARD ( -- )    Mark the most recently used buffer as unmodified, preventing it from being written
                    back to disk.
1 >UPDATE !         Store a one in the update field in the 1st entry, marking it as unmodified.
;

```

The update cell in the buffer pointer entry is very important in the virtual memory management

system. When this cell is set to true (-1), nothing will happen for the moment. However, when this buffer space is assigned to a new disk buffer and before the data in the new block is brought in from the disk, the contents of this buffer will be written back to disk to where it came from. This way, any change we made in the disk buffer will eventually be written back to disk. On the other hand, if the update cell is set to 0 or 1, presumably that the contents of the disk buffer is the same as those on the disk, there is no need of writing the data in the disk buffer back to the disk. Therefore, new disk block can be brought into this buffer immediately without flushing the old block back to the disk. The disk accessing can thus be reduced while the integrity of data on disk is assured.

```

: MISSING ( -- )          Discard the least recently used disk buffer. If this buffer was marked as
                          modified, it is written back to disk. The first three buffer pointer entries
                          are then shifted down by one entry. The first entry is made available to the
                          new block to be brought in.
>END 2- @                The address of the update cell in the last buffer pointer entry, which is the
                          least used one.
0< IF                    If it contains a true flag, write the buffer data back to disk
. >END 8 -               The block number of the last entry.
  WRITE-BLOCK           Write this buffer back to disk.
  >END 2- OFF           Reset the update cell.
  THEN
  >END 4 - @            The buffer address of the last entry.
  >BUFFERS 4 + !       Make it the buffer address of the 0th entry.
  1 >BUFFERS 6 + !     Mark the 0th entry unmodified.
  >BUFFERS             Source address of the down shift of pointer entries.
  DUP 8 +             Target address of the down shift.
  #BUFFERS 8*         Total bytes to be shifted.
  CMOVE>             Move from the last byte to first.
;                      Last pointer entry is discarded. First entry is initialized for a new block of
                          data.

: (BUFFER) ( n fcb --   Assign a disk buffer to block n and return the buffer address on the stack. Block
  addr )               n is not read in from the disk.
  PAUSE                Allow other tasks a chance of execution.
  ABSENT?              Is block n already in one of the disk buffers?
  IF                   No. A buffer has to be allocated to block n.
  MISSING              Shift the pointer entries.
  1 BUFFER#            Get the first entry.
  4 + @                Fetch the buffer address therein.
  THEN ;

: BUFFER ( n -- addr ) Do (BUFFER) on the current file.
  FILE @              Fcb of the current file.
  (BUFFER)            Assign a buffer to the disk block. Write the old block in the buffer to disk if
                          it was updated.
;

: (BLOCK) ( n fcb --   Return the address of a buffer which contains data from block n. If block n is
  addr )               not already in one of the buffers, it is read in from the disk.
  (BUFFER)            Assign a buffer to the requested block.
  >UPDATE @           Get the update field.
  0>                  Is it 1?
  IF                   Yes. The block is not in the buffer.
  1 BUFFER# DUP       Read it from the disk.
  READ-BLOCK
  6 + OFF             Reset the update flag to false.
  THEN ;

VARIABLE FILE         Pointing to the file control block of the current file.
VARIABLE IN-FILE     Pointing to the file control block of the second opened file or the in-file.

: BLOCK ( n -- addr ) Read a block from the current file if it is not in the buffer. Return the buffer
  FILE @              Fcb of the current file.
  (BLOCK)            Read it.
;

```

F83 allows you to open and use two files concurrently. The first file is opened with the command OPEN and is referred to as the current file. The second file is open by the command FROM and is called the in-file. The current file is always used as the output file and the in-file is always used as the input file. This way you can copy blocks from one file to another. When OPEN is executed, the invoked file is set to be both the current file and also the in-file so that you can read and write to the same file. The file control block address of the current file is stored in FILE, and that of the in-file is in IN-FILE.

```
: IN-BLOCK ( n -- addr )   Read a block from the in-file which is the second file opened to the system.
  IN-FILE @               Get the fcb of the in-file.
  (BLOCK)                 Read it.
;
```

BLOCK is the most important command to communicate with the disk. It is the virtual memory manager. If we need any block of data from disk, just give BLOCK the block number and it will make sure that you have the data in one of the disk buffers. From the address returned by BLOCK, you can access the disk block data using the regular memory accessing commands. If you remember to set the update cell when you change the data in the disk buffer, BLOCK will see to it that the modified data will be written back to disk. This is done explicitly using the UPDATE command. You can command BLOCK to ignore any change you made in a disk buffer by the command DISCARD.

In cases that you want to write raw data on to a fresh disk or you do not want to read in the disk block, BUFFER is the command to use because it does not do the disk read. You can use BLOCK for the same purpose, but then you will do a useless disk read operation. When you are writing a large file on to the disk, BUFFER can save you quite some time because only write operations are performed.

7.6. Saving Disk Buffers to Disk Files

BLOCK and BUFFER will write to disk only when disk buffers are full and new disk blocks are requested. If the computer is turned off, the buffers will be lost because their contents do not have a chance of being written back. The following commands force the system to write all the updated buffers back to disk. They are highly recommended, especially when you are doing editing work.

```
: SAVE-BUFFERS ( -- )   Write back all the updated buffers to disk and then mark them all as unmodified.
  1 BUFFER#             Address of the 1st pointer entry.
  #BUFFERS 0 DO         Scan all the pointer entries.
    DUP @               Get the block number.
    1+ IF               Block number cells were initialized to -1 as empty buffer. Make sure the buffer
                       is not empty.
    DUP 6 +             Address of the update cell.
    @ IF                Is the buffer updated?
    DUP WRITE-BLOCK     Yes. Write it back to disk.
```

```

    DUP 6 + OFF          Reset the update cell.
    THEN
    8 +                  Address of the next entry.
    THEN
    LOOP
    DROP                Discard the entry address.
;

: EMPTY-BUFFERS ( -- ) First wipe out the data in the buffers. Initialize the buffer pointers to point
to the right addresses in memory and reset all the update cells.
FIRST LIMIT           Boundary of disk buffers.
OVER - ERASE         Erase the entire disk buffer area.
>BUFFERS             Buffer pointer array.
#BUFFERS 1+ 8 *      Bytes in the pointer array.
ERASE                Clear the pointer array.
FIRST               1st buffer address.
1 BUFFER#           Address of the 1st pointer entry.
#BUFFERS 0 DO       Go through all pointer entries.
DUP ON              Initialize the block number cell.
4 + 2DUP !          Initialize the buffer address cell.
SWAP B/BUF +        Address of the next buffer.
SWAP 4 +            Address of the next pointer entry.
LOOP
2DROP ;             Clear the stack.

: FLUSH ( -- )       Save and empty all the buffers.
SAVE-BUFFERS
0 BLOCK DROP        Cheat the CP/M system to defeat its extra buffering in BIOS. By accessing a dummy
                    block, you can be sure that the old one is flushed out of the pipeline and written
                    to disk.

EMPTY-BUFFERS ;

```

Whenever you change disk, be sure to FLUSH out all the buffers to the old disk. During program developments, if you have any concern about losing data or crashing the system, FLUSH the buffers first. If you are absolutely sure that the data in the buffers are corrupted, use EMPTY-BUFFERS to clear the buffers. If you want to throw away only one buffer, use DISCARD immediately after you access this buffer by BLOCK, making it the most recently used buffer.

Chapter 8. Dictionary and Vocabulary

The source code discussed in this chapter is in the file KERNEL86.BLK, Screens 67-68, and 76.

If you had a figForth system, you might have noticed that it took a while to compile a screen of text. If you were to load a sizable system or application program, it might seem to be a long time before the computer came back and put an 'ok' on the screen. The reason is that the dictionary in figForth is basically a single, linearly linked list of commands. It takes some time for the text interpreter to travel through this list to find a command. The worst cases are the numbers. If the text interpreter cannot find the command in the context vocabulary, it will search again in the current vocabulary, which in most cases is the same as the context vocabulary with the entire root FORTH vocabulary tagged at the end.

F83 improves this situation by breaking the dictionary into four separately linked lists. To locate a command, only a quarter of the dictionary needs to be searched. This strategy visibly enhances the performance of the text interpreter. In this section, I hope that I can explain how this dictionary structure is implemented.

8.1. Threading of the Dictionary

First, there are several important system variables which perform the house keeping chores in managing the vocabulary and the searching of dictionary:

VARIABLE DP	Pointer to the top of the dictionary. Returned by HERE.
VARIABLE CURRENT	Pointer to the current vocabulary to which new definitions are linked.
8 CONSTANT #VOC	The number of vocabularies to be searched, as specified by the array in CONTEXT.
VARIABLE CONTEXT	The context vocabulary pointer.
#VOCs 2* ALLOT	Space to hold 8 transient vocabulary pointers. The array specifies the search order for the text interpreter.
VARIABLE VOC-LINK	Pointer to the most recently defined vocabulary. Vocabularies are thus linked in the order of their creation.

The 8 numbers stored in the transient array are the parameter field addresses of up to eight different vocabularies. The text interpreter searches up to eight vocabularies and stops at the first encounter of the name it looks for.

Next, let us see how the vocabularies are defined and how to select the context and current vocabularies.

: VOCABULARY (--)	Define a new vocabulary.
CREATE	Take the following string as the name of the new vocabulary.
#THREADS 0 DO	Compile four 0's in the parameter field.
0 ,	They are the four threads
LOOP	in the dictionary for the new vocabulary.

```

HERE                               The next cell is for the vocabulary link, VOC-LINK.
VOC-LINK @ ,                       Old vocabulary link is placed in this cell.
VOC-LINK !                           The new vocabulary is the last in the vocabulary link list. Its link address must
                                       be stored in VOC-LINK.
DOES>                               End of the compilation of a new vocabulary entry in dictionary. Next is the
                                       vocabulary interpreter:
CONTEXT !                             Store the parameter field address of this vocabulary in the first cell of the
                                       CONTEXT array so that this vocabulary will be searched first by the text
                                       interpreter.
;

: DEFINITIONS ( -- )               Link subsequent definitions to the context vocabulary.
CONTEXT @                             Get the address of the context vocabulary.
CURRENT !                             Store it in CURRENT. New definitions will be linked to the vocabulary pointed
                                       to by CURRENT.
;

```

The interesting things are how new commands are linked to the current vocabulary and to the threads in the dictionary. We may think that the vocabularies are the logical groupings of commands in the dictionary and the threads are the physical groupings of commands in the dictionary. New commands are created by CREATE, which invokes "CREATE to build the name fields and link fields:

```

: "CREATE ( -- )                   Create an header for a new definition. The header consists of a view field, a
COUNT                               link field, and a name field.
HERE EVEN 4 +                         Character count in the name.
PLACE                                 Address of the name field.
ALIGN                                  Move the name string into the name field.
,VIEW                                  Align the header to cell boundary because the view field contains a 16 bit integer.
                                       Lay down the view field in which the top 4 bits contain a file number and the
                                       lower 12 bits contain a block number in the file.
HERE 0 ,                               Save a cell for the link field to be filled later.
HERE LAST !                           Store the name field address in LAST.
HERE                                   ( lfa nfa ) Get the name field address.
WARNING @                             If the warning flag is set, search the dictionary to see if the name is unique.
IF FIND                               If it is an existing name,
  IF HERE COUNT TYPE                  print the name, ."isn't unique" with an error message.
  THEN
DROP HERE                             Clean the stack after DEFINED.
THEN
CURRENT @ HASH                         Hash the first character of the name with the current vocabulary to return one
                                       of the four threads to be extended.
DUP @                                  Get the name field address of the last definition of this thread.
HERE 2-                                The link field address of the current definition.
ROT !                                  Store this link field address in the head of thread in the current vocabulary.
SWAP !                                 Store the link field address of the last definition in the link field of the current
                                       definition and extend the linked chain.
HERE                                   Name field address saved on stack.
DUP C@                                 Character length of name.
WIDTH @ MIN 1+                         Width of the name field.
ALLOT ALIGN                            Name field allocated.
128 SWAP CSET                          Set the MSB of the length byte, the first byte in name field as a name field
                                       delimiter.
128 HERE 1- CSET                       Set the MSB of the last byte in name field as another delimiter.
COMPILE [                               Turn on the interpreter.
DOCREATE ,                             Compile the variable interpreter in the code field.
;                                       Thus complete the header.

```

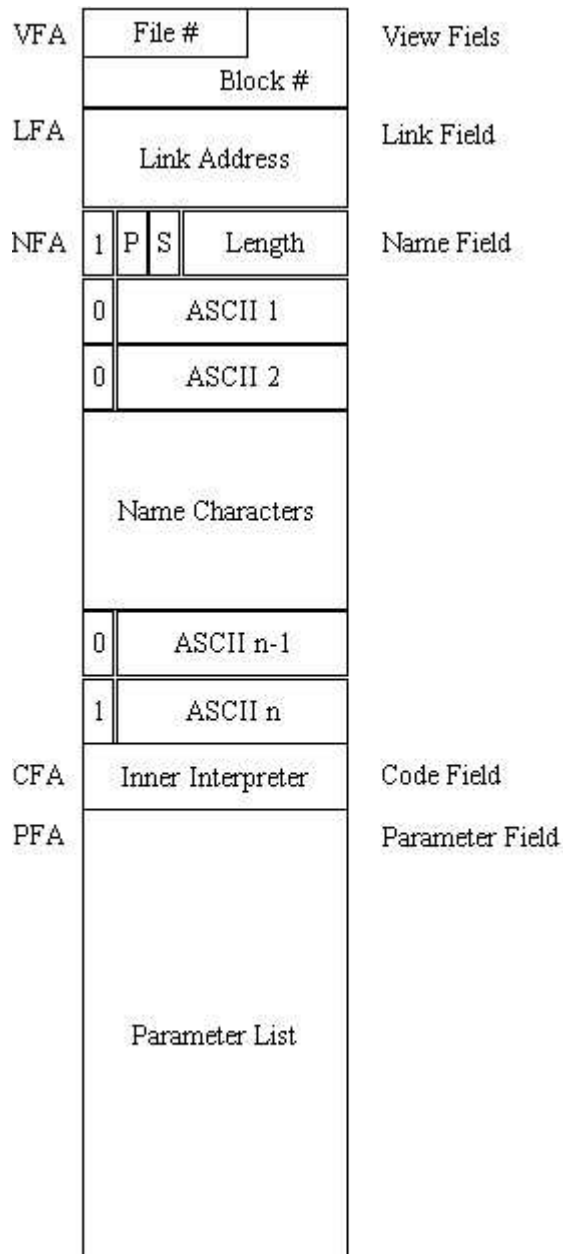

Figure 8.1 Structure of a Forth command

The header in this F83 Forth is not the same as the other more popular Forth systems. A view field is added to help you locating a command in one of the CP/M files containing Forth source screens. The link field is placed before the name field so that the string comparisons can be performed more quickly without traversing through the name field. The linking of dictionary entries involves only the link fields. Name fields are no longer involved in the linkage.

8.2. Hashing and Searching the Dictionary

Two important commands in "CREATE above was not fully explained: HASH and DEFINED. These are the key commands used by the text interpreter to search specific commands in the dictionary. HASH is a code command. DEFINED, however, is a high level colon command which eventually calls a code command (FIND) to do the actual searching. Let us look at HASH and (FIND):

```

CODE HASH
    ( string-addr vocabulary-pfa -- thread-addr )
    Given a string address and a pointer to a vocabulary, return the address of the
    thread in the parameter field of the vocabulary.
    CX POP      Pfa of the vocabulary.
    BX POP      Address of the string.
    BX INC      Address of the first character.
    0 [BX] AL MOV  Get the first character which is the key of hashing.
    3 # AX AND    Use only the two LSB bits.
    AX SHL       Multiply it by 2 to get the cell offset to the proper thread.
    CX AX ADD     The actual address of the thread.
    1PUSH        Push the thread on stack and return.
END-CODE

CODE (FIND)
    ( here lfa -- cfa true, if found; here false, if not found.)
    Given the address of a string and the link field address of a word in dictionary,
    search the dictionary and return an address and a flag on the stack. Flag=1 for
    an immediate word; flag=-1 for a regular word; and flag=0 if the word is not found.
    If not found, the string address remains on the stack.
    DX POP      The link field address.
    DX DX OR    Test it.
    0= IF
    AX AX SUB   Lfa is 0.
    1PUSH       Push a false flag and return.
    THEN       Lfa not 0. Start comparing strings.
    BEGIN
    DX BX MOV   BX now points to the name field of the dictionary entry.
    BX INC BX INC Here.
    DI POP     Get the string address to DI.
    DI PUSH    Get the length byte of the dictionary entry.
    0 [BX] AL MOV  Get the length of the dictionary entry.
    0 [DI] AL MOV  Compare it with the string length.
    63 # AL AND   Mask of two most significant bits, delimiter and precedence bits.
    0= IF       Length bytes not equal, go for the next entry in the thread.
    BEGIN
    BX INC     Length bytes equal, now scan the strings.
    DI INC     Next character.
    0 [BX] AL MOV  From the dictionary entry.
    0 [DX] AL XOR  Compare with the one at HERE.
    0<> UNTIL    If equal, continue the comparison.
    127 # AL AND   Not equal. See if it is the last character in the name field.
    0= IF       Not the last character. Strings are not the same. Go for the next entry in the
    thread.
    DI POP      Rid of the HERE.
    BX INC     Get the code field address.
    BX PUSH    Push it on the data stack.
    DX BX MOV   Get the link field address back to BX again, checking precedence bit.
    BX INC BX INC  Increment to the name field address.
    0 [BX] AL MOV  Get the length byte again.
    64 # AL MOV   Examine the precedence bit.
    0<> IF       Not an immediate word.
    1 # AX MOV    Set indicator to 1 for immediate word.
    ELSE
    -1 # AX MOV   Not immediate, set AX to -1.
    THEN
    1PUSH       Push the indicator on stack and return.
    THEN
    THEN
    DX BX MOV   String comparison failed. Prepare to test the next entry in the thread.
    0 [BX] DX MOV  Get the link field address of the next entry in the thread from the link field
    of this entry.
    DX DX OR    Is the next link field address zero, end of the thread?
    0= UNTIL    Not the end of thread. Loop back for the next entry.
    AX AX SUB   End of the thread,
    1PUSH       push a false flag on stack and return.
END-CODE

```

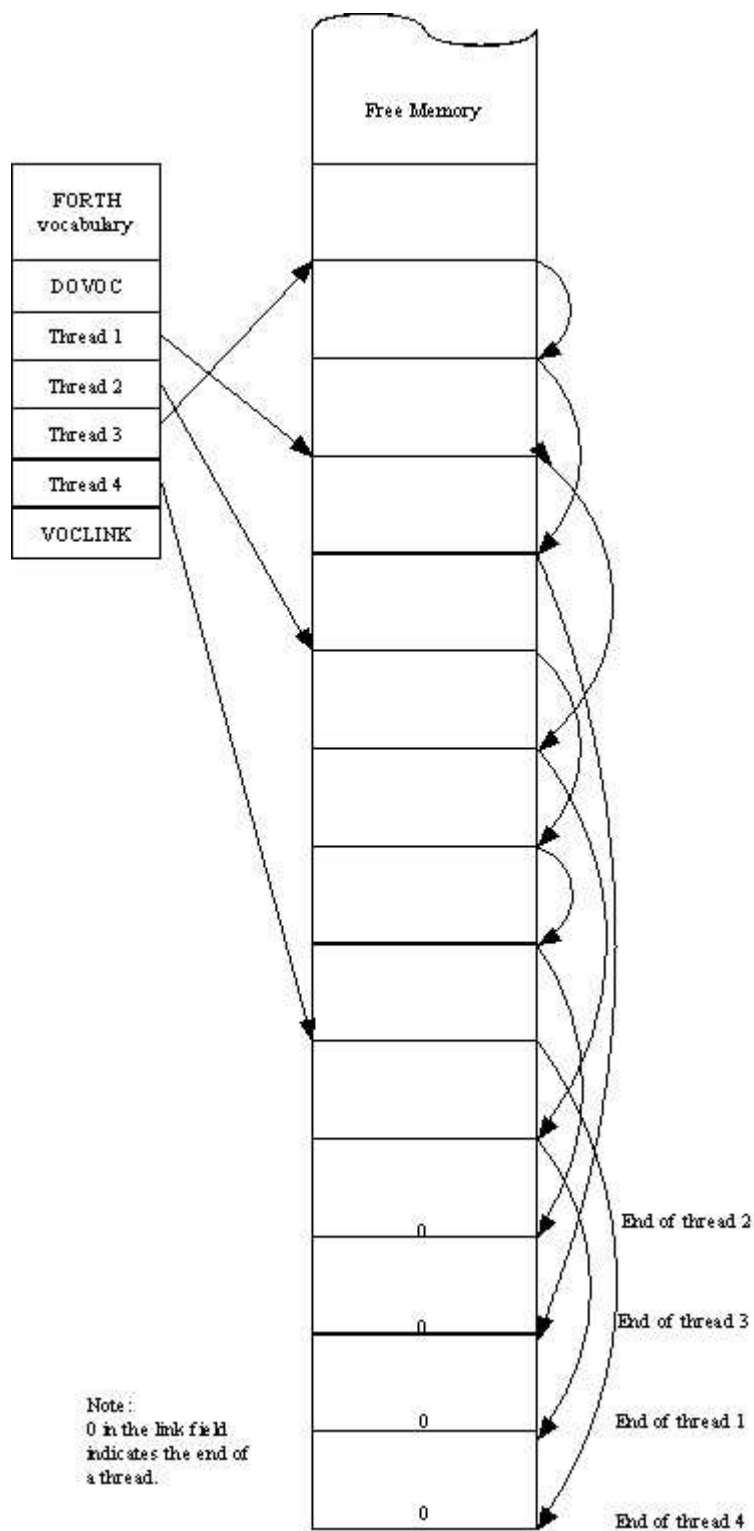



Figure 8.2 Four-way threading in a vocabulary.

(FIND) searches through one thread, with a given link field address of a dictionary entry. To pick up one thread among four for searching and to do the searching, a high level command FIND has to be used.

```

4 CONSTANT #THREAD      Number of threads implemented in this Forth system.

: FIND                  ( string-addr -- cfa true, if found; string-addr false, if not found)
  DUP C@ IF             If the string is not a null string, do the dictionary searching. Otherwise, do
                        the end of line processing.
  PRIOR OFF             PRIOR is a user variable storing the last vocabulary searched. Clear PRIOR to
                        begin searching.
  FALSE                This is a dummy flag for the next do-loop.
  #VOCS 0 DO            #VOCS=8, the number of vocabularies to be searched.
  DROP                 Drop the flag on stack.
  CONTEXT I 2* + @     Get the vocabulary address in the CONTEXT array.
  DUP IF                If the vocabulary address is zero, skip it because no vocabulary was specified
                        for this CONTEXT entry.
  DUP PRIOR @           Get the contents of PRIOR, the last vocabulary searched.
  OVER PRIOR !         Update PRIOR with the vocabulary to be searched now.
  = IF                 If the PRIOR vocabulary is the same as the present vocabulary, here is no need
                        of repeating the searching.
  DROP FALSE           Drop the vocabulary and replacing with a false flag. Loop back.
  ELSE                 Now search the new vocabulary.
  OVER SWAP            Save a copy of the string address.
  HASH                 Hash the string and return the address of the head of a thread in the present
                        vocabulary.
  @                    Pick up the thread, the link field address of the last entry in this thread in
                        the dictionary.
  (FIND)               Search the dictionary.
  DUP ?LEAVE           If tos is a true flag, a word is found in the dictionary. Leave the loop immediately.
                        If tos is false, repeat the loop and search the next vocabulary.

  THEN
  THEN
  LOOP
ELSE                     Null string processing.
  DROP                 Discard the string address.
  END? ON              Turn on the end-of-line flag.
  ['] NOOP 1           Push the NOOP address on the stack with a true flag so that the end-of-line process
                        will happen immediately.

THEN ;

```

FIND thus scans the CONTEXT array, where up to 8 vocabularies can be specified and are to be searched in the order of the array. When a vocabulary is to be searched, HASH selects one of the 4 threads, which are the link field addresses of the last entries in each of the threads stored in the parameter field of the vocabulary, and hands the proper link field address to (FIND) to scan the thread for a name matching the given string. When a vocabulary was searched, its address was preserved in PRIOR to avoid searching the same vocabulary repeatedly. This allows the same vocabulary to be specified in the CONTEXT array more than once without being searched more than once. FIND can also skip nulls in the CONTEXT array. Nulls and multiple vocabulary entries in CONTEXT are conveniences in manipulating vocabulary searching order, which will be discussed in a moment.

```

: DEFINED              ( -- addr flag )
  Parse out the next word in the nput stream and search the dictionary. If a matching
  entry is found, return its cfa and an 1 or -1. If not found, return HERE and a
  false flag.
BL WORD                Parse the next word, delimited by blank characters, and copy the word to HERE,
                        the word buffer.
CAPS @ IF              If the contents of CAPS is true, the word will be converted to upper case characters.
  DUP COUNT UPPER     Upper the cases.
  THEN
  FIND                 Now do the searching.
;

```

If an immediate command is found by FIND, the return flag is 1. If the found command is a regular,

non-immediate, command, -1 is returned. It is important for the colon compiler to know whether a command is immediate or not. The colon compiler normally compiles the code field addresses of regular commands, but executes the immediate command to take care of special compiling conditions or to build structures in a colon command.

In F83, because of the more complicated CONTEXT structure, it requires a few more commands to handle the vocabularies and to use them effectively. When a vocabulary is invoked, its parameter field address is stored into the first cell in the CONTEXT array. Next time a search is initiated, this vocabulary will be the first vocabulary to be searched. The command ONLY is used to initialize the CONTEXT array and places the address of a very small searching control vocabulary in the first and the last cell of the CONTEXT array. The commands in this control vocabulary allow us to select appropriate working vocabularies like FORTH, etc. The command ALSO copies the first CONTEXT entry to the second entry and moves the second and subsequent entry up by one cell, adding one entry to the searching order. This set of commands can be used to specify any searching strategy within the size of the CONTEXT array.

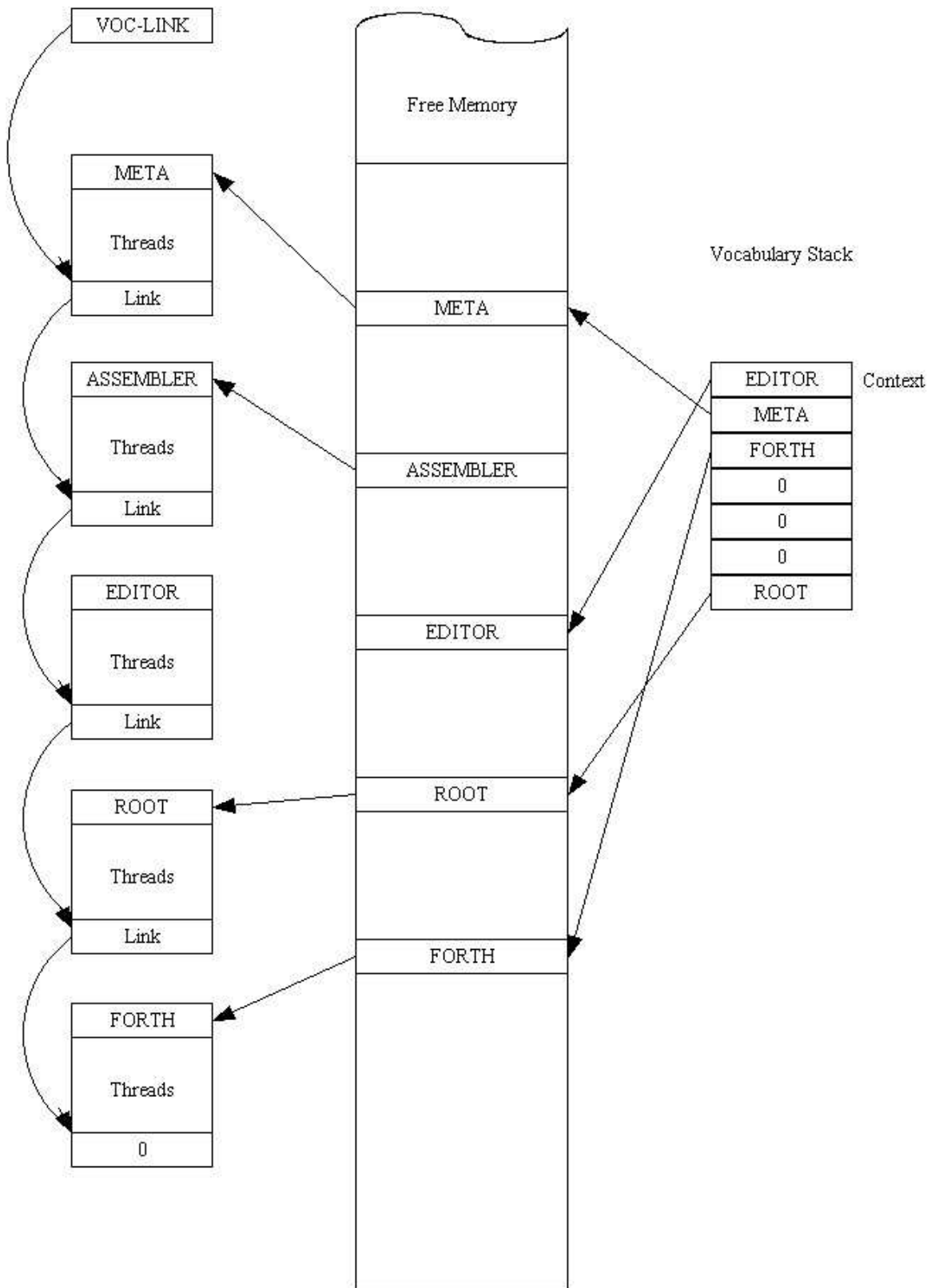

Figure 8.3 Vocabularies and the dictionary structure.

Chapter 9. Number Input and Output

The source code discussed in this chapter is in KERNEL86.BLK file, Screens 58 to 61.

The Forth interpreter can only recognize two types of commands: commands or Forth commands compiled into the dictionary, and numbers. A large portion of the Forth system is devoted to processing numbers, including inputting numbers from console or disk, doing arithmetic and logic operations on them, and outputting them to console or other devices in a required format. In the nucleus layer, we've seen lots of arithmetic and logic operators. In this chapter, we will discuss how numbers are converted from the external representation in ASCII strings to the internal representation in the binary form, and vice versa.

9.1. Representation of Numeric Data

A very interesting aspect of Forth in its external representation of numbers is that numbers can be presented in many different bases. Not only decimal, octal, hexadecimal, and binary, but also in any reasonable base from 2 to 70, limited by the number of ASCII characters available to represent digits. The reason is that in Forth the primitive number input and output commands are directly accessible to you, giving you tools that you can use at will to define and modify rules in doing number input and output.

Internally, all numbers are represented in 16 bit binary form and processed in 16 bit units. In the case that more bits are required to represent large integer numbers, two 16 bit numbers are used together as a 32 bit double precision integer. For data requiring less than 16 bits, they are generally right justified in the 16 bit field and the high order unused bits are cleared to zeros.

F83 uses many different data types. Their ranges are show in the following table:

Table 9.1. Data Representation

Date Type	Range
True flag	-1 or 32767
False flag	0
ASCII codes	0..127
Byte	0..255
Integer	-32768..32767
Unsigned integer	0..65535
Address	0..65535
Double integer	-2,147,483,648..2,147,483,647
Unsigned double integer	0..4,294,967,295

Forth is not a typed language. We can talk about data types and their external representations, but

once they are inside the Forth computer, they are all represented in the uniform 16 bit format. Forth doesn't care what type a number was when it is input into Forth. Thus you can do arithmetic on the flags and ASCII codes like any other number. You have to know what you are doing. You must use the right operator to process the data you entered. This is the price you have to pay for the convenience in using the data stack.

F83 maintains three user variables specifically for the purposes of number input/output:

VARIABLE BASE	The current base for number input and number output conversions. a 10 stored in BASE causes input number strings to be treated as decimal numbers. A 16 in BASE makes the conversions done in hexadecimal.
VARIABLE DPL	The decimal point location. It stores the location of the decimal point in an ASCII number string, from the right end of the string. In other words, the number of digits after the decimal point.
VARIABLE HLD	The number of digits stored in the number output buffer for output.

9.2. Input Number Conversion

The text interpreter parses a word out of the input stream and places the parsed word in the word buffer, just above the last entry in the dictionary. It first searches the dictionary to see if the word is a pre-defined Forth command. If it fails to match the parsed word to a command, the parsed word is left in the word buffer for the number conversion routine to convert it to a number. The following set of F83 commands support the number conversion process.

LABEL FAIL	A common return routine used when failed to convert the string to a number due to a number of reasons.
AX AX SUB 1PUSH	Push a false flag on the stack and return to the NEXT routine.
CODE DIGIT (char base -- n f)	Return a flag indicating whether or not the character is a valid digit in the current base. If so, return the converted value with a true flag. Otherwise, return the character with a false flag.
DX POP	Pop base into DX.
AX POP	Pop character into AX.
AX PUSH	Push character back to stack just in case of a conversion failure.
ASCII 0 # AL SUB	Subtract ASCII 0 (48) from the code of the given character.
FAIL JB	If char is below 0, it is not a valid digit. Jump to FAIL.
9 # AL CMP	Is char > 9?
> IF	No, a regular digit. Skip to DIGIT1.
17 # AL CMP	Is char between 9 and A?
FAIL JB	Yes. Invalid digit. Jump to FAIL.
7 # AL SUB	Eliminate the gap between 9 and A. A must be the next digit following 9.
THEN	
DL AL CMP	AL has the converted value. Is it in the range of BASE?
FAIL JAE	If the value is equal or above the base value, it is not a valid digit. Jump to FAIL.
AL DL MOV	Copy value to DL for DPUSH.
AX POP	Discard char from the stack.
TRUE # AX MOV	Put true flag in AX.
2PUSH	Push value and flag on stack and return.
END-CODE	

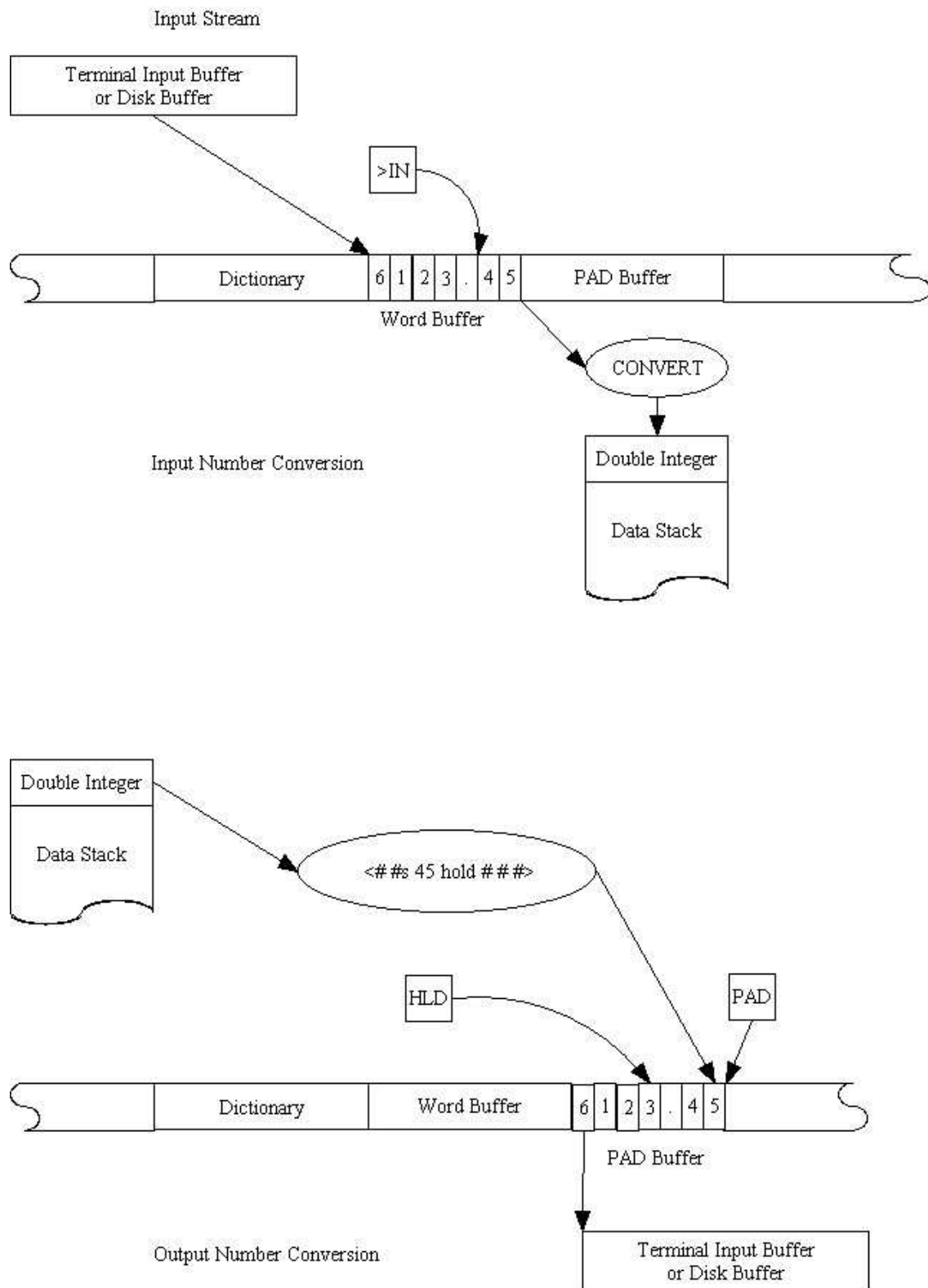

Figure 9.1 Input and output number conversions

The sequence of digits is from 0 to 9, and from A up if the base value is greater than 10. Theoretically the sequence can go up to tilde (~ ASCII 126). Then anything you type would be

converted to a number.

```

: DOUBLE? ( -- f )      Return a true flag if a period is encountered in the number string.
DPL @                  Get the contents of DPL. If no period is in the number string, DPL is -1 as
                        initialized.
1+                    0 if no period.
0<>                  Logic NOT.
;

: CONVERT ( ud1 addr1 -- Starting with the unsigned double integer ud1 on stack and the number string at
ud2 addr2 )           addr1, convert the string to a number and add to ud1 according to the current
                        base. Leave the resulting double integer and the address of the unconvertable
                        digit addr2 on stack.
BEGIN                This is an indefinite loop.
1+                    Get the next character in the string.
DUP >R C@            Get one digit and save a copy of its address on return stack.
BASE @ DIGIT        Convert one digit.
WHILE                Exit the loop if the digit is invalid.
SWAP BASE @ UM*     Left shift the upper half of the double integer by one digit.
DROP                Keep only the lower half of the product.
ROT BASE @ UM*     Left shift the lower half of the double integer by UM*. Result is a double integer
                        sitting on top of the value of converted digit and the left-shifted upper half
                        of ud1.
D+                    This is tricky, but the result s ud1*base+value.
DOUBLE?            Have we seen a period?
IF 1 DPL +! THEN   Yes, we get one more digit after the period. Increment DPL.
R>                 Recall the character address.
REPEAT
DROP                Discard the invalid digit left by DIGIT.
R>                 Address of the invalid digit.
;

: (NUMBER?) ( addr -- d Given a string at addr with at least one digit, convert it to a double integer.
flag )
0 0                  The initial value of the double integer serving as accumulator.
ROT                  Get addr to top of stack.
DUP 1+ C@           Get the first digit.
ASCII - =           Compare it to ASCII - sign.
DUP >R             Save the negative flag on return stack.
-                  Otherwise, start conversion at the current address.
-1 DPL !           Initialize DPL.
BEGIN
CONVERT             Convert the number string.
DUP C@             Get the invalid digit.
ASCII , ASCII /    them is a valid punctuation mark, equivalent to a period.
BETWEEN            A punctuation mark is encountered. Reset DPL.
WHILE 0 DPL !     Ignore the punctuation mark and continue converting the rest of the number string.
REPEAT
-ROT              Rotate the invalid character address below the double integer.
R>                 Get the negative flag.
IF DNEGATE THEN   If the number is preceded by a - sign, negate the double integer.
ROT C@ BL =       Compare the last invalid digit with blank and leave the result on stack as a flag.
;

```

F83 accepts numbers with an optional preceding - sign for negative numbers. Within the number string, four punctuation marks, ',', '-', '.', and '/' are allowed. When any of these punctuation marks appear in the string, DPL is reset to zero so that CONVERT can keep track of the number of digits following the punctuation mark, and the converting process continues on until an invalid digit other than these punctuation marks is encountered.

```

: NUMBER? ( addr -- d f ) Convert the number string at addr to a double integer. The number string may
                        be preceded by a - sign, but must be terminated by a blank. The location of the
                        last punctuation mark is saved in DPL. A true flag is left on the stack if
                        successful.
FALSE                Put up a default flag on stack.
OVER COUNT BOUNDS   Set up loop limits to scan the supposed number string.
?DO                 Scan the string for valid digit.
I C@ BASE @ DIGIT   Is this a valid digit?

```



```

NIP                I don't care its value now.
IF DROP TRUE LEAVE Leave the loop with a true flag if a valid digit is found in the string.
THEN
LOOP              The purpose of this test is to filter out a mistyped word in which case it is
                  just a waste of time to do the number conversion.
IF (NUMBER?)      Do the conversion if the string is potentially a number.
ELSE              No valid digit in the string.
  DROP            Discard its address.
  0 0             Put a null double integer on stack.
  FALSE          Top it with a false flag.
THEN              ;

: (NUMBER) ( addr -- d ) Convert a number string to a double integer. The string may have optional leading
- sign and embedded punctuation. It must be terminated by a blank.
NUMBER?           Conversion.
NOT               If not a number or not terminated by a blank,
?MISSING         print an error message and abort.
;

DEFER NUMBER      Vectored to (NUMBER).

```

With this set of input conversion tool, we can type in numbers like:

```
415-424-3001 12/25/1983 123.45 -0.4567 987,654,321 534,234.00
```

If we are in hexadecimal base the following numbers are also valid:

```
A1 F9 BAD-FAD FEED/BEAD -1B2A5D.0
```

However, after conversion, they are all internally represented by double integers. The embedded punctuation marks have no effect on the conversion except the contents of DPL.

9.3. Output Number Conversion

The primitive Forth output conversion routine converts a double integer to an ASCII string suitable for outputting to a console or to a printer. You can explicitly format the string and insert special characters into the string to design formats you desire. Let's look at these small tool commands first and then see how they are strung together to build number output commands often used in routine Forth programming.

```

: HOLD ( char -- ) Insert the character char into the output string. HLD contains a character pointer
to the output text buffer where the number output string is being constructed.
The number character string is built backwards from the least significant digit
to the most significant digit. To insert a character into this string HLD has
to be decremented.

-1 HLD +!
HLD @      Get the character pointer.
C!         Insert char to where HLD points.
;

: <# ( -- ) Initialize the number conversion process.
PAD        PAD returns the location of the text buffer used for output.
HLD !     Point HLD to PAD so that the number string can be built in the PAD buffer.
;

: #> ( d -- addr len ) Terminate the output number conversion and leave the address and length of the
number string on stack suitable for TYPE to print out.
2DROP     The double integer on stack is no longer needed.
HLD @     The address of the number string.
PAD       The end of the string.
OVER -    The length of string.
;

: SIGN ( n -- ) If n is negative insert a minus sign into the number string.
0< IF     If n is negative,

```

```

ASCII - HOLD      Insert the minus sign.
THEN ;

: # ( d1 -- d2 )  Convert one digit and add the digit to the number string. The conversion is to
                  divide d1 by base. The quotient d2 is left on stack and the remainder is converted
                  to ASCII code and add to the output buffer.
BASE @ MU/MOD     Divide d1 by base. The remainder and the double integer quotient are left on
                  stack.
ROT              Get the remainder to top.
9 OVER <         If the remainder is greater than 9,
IF 7 + THEN      add 7 to make A.
ASCII 0 + HOLD   Convert to ASCII code and HOLD it in the output buffer.
;

: #S ( d -- 0 0 ) Convert a double integer until finished.
BEGIN
#                Convert one digit.
2DUP OR          Is the quotient 0?
0= UNTIL         If it is zero, exit the loop. Otherwise, continue converting.
;

```

With these tools, we can format numbers for output in any format we want. However, it is always nice to look at how the F83 designers built some of the standard number output commands.

```

: (U.) ( u -- addr len ) Convert an unsigned single integer to a number string.
0                          Make the unsigned integer a double integer.
<#                          Initialize the conversion.
#S                          Convert all digits.
#>                          Prepare for output.
;

: U. ( u -- )           Output an unsigned single integer with one trailing space.
(U.)                       Convert.
TYPE SPACE                 Print.
;

: U.R ( u len -- )     Output an unsigned integer in a field of len columns.
>R                          Save the column width.
(U.)                       Convert.
R>                          Recall column width.
OVER - SPACES              Output appropriate number of spaces so that the number string will come out right
justified.
TYPE                       Output the string.
;

: (.) ( n -- addr len ) Convert a signed single integer to a number string.
DUP ABS                     Get the absolute value of n.
0                            Make it a double integer.
<# #S                       Convert all digits.
ROT SIGN                    Add a minus sign if n is negative.
#>                          Finish the output string.
;

: . ( n -- )           Output a signed integer with a trailing space.
(.)                       Convert.
TYPE SPACE               Type.
;

: .R ( n len -- )     Output a signed integer right justified in len columns.
>R (.)                   Convert n first.
R> OVER - SPACES        Pad with leading blanks.
TYPE                     Now print the number right justified.
;

```

9.4. Double Integer Output

```

: (UD.)              ( ud -- addr len )
                    Convert an unsigned double integer to a number string.
<# #S #> ;

```

```

: UD. ( ud -- )      Output an unsigned double integer with a trailing space.
(UD.)
TYPE SPACE ;

: UD.R ( ud len -- ) Output an unsigned double integer right justified in len columns.
>R (UD.)
R> OVER -
SPACES TYPE ;

: (D.) ( d -- addr len ) Convert a signed double integer to a number string.
TUCK      Save a copy of the upper half of the double integer under the double integer. We
          will need its sign.
DABS      Convert the double integer to its absolute value.
<# #S     Convert all digits.
ROT       Get the saved upper half of the original double integer
SIGN      Put up its sign.
#>       All done.
;

: D. ( d -- )      Output a signed double integer with a trailing space.
(D.)
TYPE SPACE ;

: D.R ( d len -- ) Output a signed double number right justified in len columns.
>R (D.) R> OVER -
SPACES TYPE ;

```

Chapter 10. Word Parsing

The source code discussed in this chapter is in the file `KERNEL86.BLK`, Screens 62 to 64.

10.1. Text Processing

In communicating with you through a console, the computer must be able to accept a line of commands and find out what is your intention. The computer then can carry out the commands and do some useful work. In most conventional operating systems, the task which accepts commands from console and interprets the contents of the commands is called a command line interpreter (CLI). The user has to observe a set of rules in entering commands, because the computer uses this set of rules to determine what has to be done, given these commands. These rules are the syntax rules, or more generally, the grammar of the command line interpreter. When the command line interpreter becomes more powerful and has more functions built into it, its syntax becomes more complicated and the syntax rules multiply very quickly.

Forth uses a very simple and straightforward syntax rule in interpreting command lines. The command line consists of a sequence of words, separated by blanks or spaces. The words represent either commands pre-compiled in the Forth dictionary or numbers. Thus the Forth command line interpreter or text interpreter can be extremely simple, comparing to CLI's in other languages or operating systems. The interpreter just has to parse out words using blanks as delimiters, searches the dictionary to locate the executable code of the commands, and executes the code. If a word is not a command in the dictionary, the interpreter will try to convert it into a number and push the number on the stack. If the word is neither a command nor a number, it is beyond the capability of the computer to do anything about it, and the interpreter will send an error message to you protesting your mistake in a very mild manner.

The tool that provides the interpreter with the ability to parse out words from a command line, or an input stream of characters, is the Forth command `WORD`. Before we get into the details of `WORD`, a few other supporting commands have to be clarified.

10.2. Input Stream and Input Buffers

First, what is an input stream? Where does the interpreter get the command lines? Forth interpreter can accept commands from two different sources: a console terminal or a disk. Two special areas in the computer memory are dedicated to store commands coming from these sources: a terminal input buffer or TIB for commands entered through the console, and one or more disk

buffers for commands coming from the disk. The terminal input buffer is managed by a number of variables and commands:

```
VARIABLE 'TIB          Contains the starting address of the terminal input buffer.

: TIB ( -- addr )     Return the address of the terminal input buffer.
  'TIB @ ;

VARIABLE #TIB         Maximum number of characters that can be held in the terminal input buffer.
VARIABLE >IN         Pointer to the character currently being processed. It is an offset from the
                    starting address of the input buffer, which is either the terminal input buffer
                    or a disk buffer.
```

The disk buffers are managed by the virtual memory management in Forth. The details of this virtual memory system are discussed in a separate chapter. Here we are only concerned with the one disk buffer which is assigned to the interpreter so that the interpreter will get its commands from this buffer. The disk block number is stored in a user variable:

```
VARIABLE BLK          Block number of source on disk to be interpreted.
```

The convention adopted by most Forth systems, including F83, is that if BLK contains a zero, the terminal input buffer is used for interpretation; otherwise, the disk block specified by BLK is used.

10.3. Low Level Parsing Commands

```
DEFER SOURCE          Vectored to (SOURCE). Return the starting address of the buffer used to hold
                    current input stream.

: (SOURCE)           ( -- addr len )
                    Return the string to be processed by the text interpreter. Addr is the beginning
                    address of the input buffer and len is the length of the input buffer.

  BLK @              Get the block number from BLK.
  ?DUP IF            If the block number is not zero,
  BLOCK              fetch the block of commands from disk and return with the address of the disk
                    buffer.
  B/BUF              Length of disk buffer is 1024 bytes.
  ELSE               If the block number is zero,
  TIB                 get the address of the terminal input buffer,
  #TIB @             and the length of it.
  THEN ;
```

Here are the hard stuff. Two code commands that scan the input stream to locate special characters in the stream.

```
LABEL DONE           A common returning point when the input stream is exhausted.
  CX PUSH            Push the contents of CX on stack and return. CX register has the remaining length
                    of the stream.

  NEXT

CODE SKIP            ( addr len char -- addr1 len1 )
                    Given the address and length of a string, and a character to look for, scan through
                    the string while we continue to find the character. Leave the address of the
                    mismatch and the length of the remaining string.

  AX POP             Move char to AX register.
  CX POP             Move len to CX register.
  DONE JCXZ          If length of string is zero, jump to DONE and return.
  DI POP            Move addr to DI register.
  DX DX MOV          Set ES=DS for string manipulations.
  DX ES MOV          Repeatedly scan the string until we find a character different from that in AX.
  REPZ BYTE SCAS    CX now has the count of characters in the remaining string. If CX is not zero,
  0<> IF
```

```

CX INC          DI is pointing to the first mismatched character.
DI DEC          Backspace.
THEN           Pointing to the last matching character.
DI PUSH        Addr1.
CX PUSH        Len1.
NEXT           Return.
END-CODE

CODE SCAN      ( addr len char -- addr1 len1 )
              Given the address and length of a string, run through the string until we find
              the character. Leave the address of the match and the length of the remaining
              string.

AX POP CX POP  Same as SKIP.
DONE JCXZ
DI POP
DS DX MOV      DX ES MOV
CX BX MOV      Set up looping parameters.
REP BYTE SCAS  Repeat if character mismatches. Scan the string.
0= IF          If the string is exhausted,
CX INC         Backspace.
DI DEC
THEN
DI PUSH        Restore string registers.
CX PUSH
NEXT           END-CODE

```

SKIP is used to skip over the leading spaces in front of a word, because words can be separated by a number of spaces allowing source commands to be free-formatted. SCAN, on the other hand, will stop at the first match. Separating these two functions into two commands gives F83 much more versatility in handle strings than older versions of Forth like figForth .

```

: /STRING      ( addr len n -- addr1 len1 )
              Index into the string by n characters. Return addr+n and len-n.
              Change n to the smaller of n and len.
OVER MIN
ROT OVER +    Addr+n.
-ROT -        Len-n.
;

: PLACE        ( from-addr len to-addr -- )
              Move the characters at from-addr to to-addr. The final string has a preceding
              length byte of len.
2DUP C!       Store the length byte.
1+            To-addr+1, address of the first character.
SWAP MOVE     Copy the string.
;

```

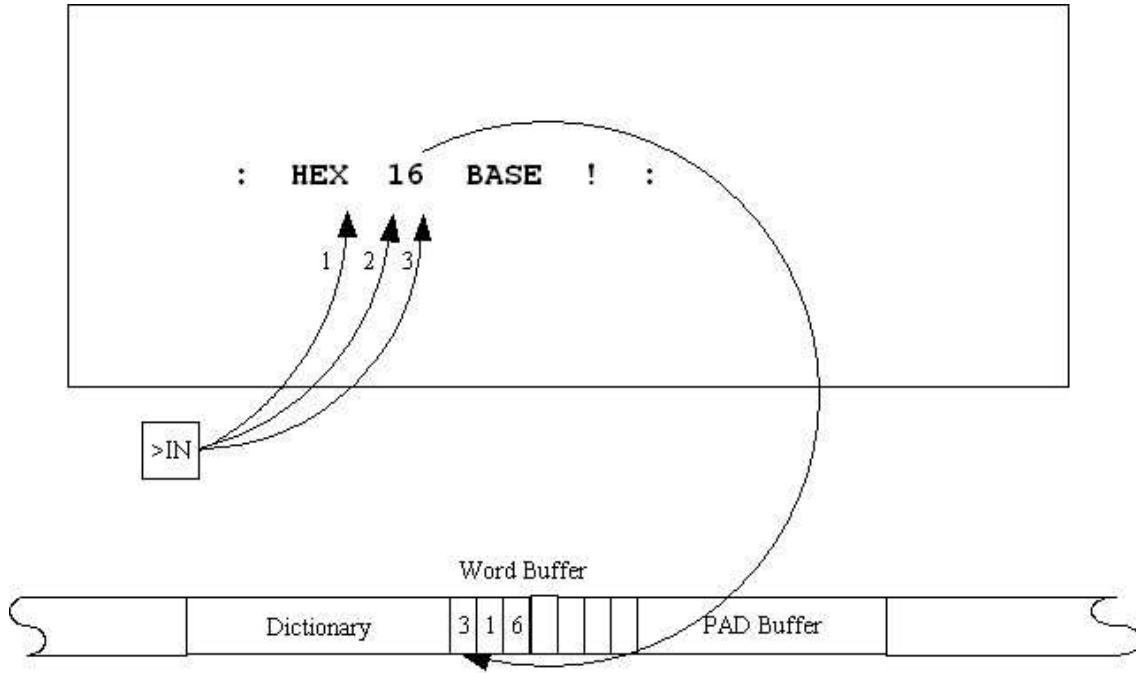

1. Start scanning after HEX in the Input Buffer.
2. Skip leading blank characters.
3. Scan string to next blank character.
4. Copy the parsed string into the Word Buffer.

Figure 10.1 Parsing with WORD

10.4. High Level Parsing Commands

The real word parsing actions are embodied in the following two commands, which scan the input stream and parse out words with specified delimiting character.

```

: PARSE-WORD      ( char -- addr len )
                  Scan the input stream until char is encountered. Skip over leading chars. Update
                  >IN pointer. Leave the address and length of the parsed word.

>R
SOURCE TUCK      Save char on return stack.
>IN @ /STRING   Get the address and length of the input buffer.
R@ SKIP        Get the current character pointer in >IN and modify addr and length accordingly.
OVER SWAP R> SCAN Skip over leading chars in the input stream starting at >IN.
>R            Scan for the next occurrence of char.
OVER - ROT     Save length of the remaining string.
R>            Addr and length of the parsed string.
DUP 0<> + - >IN +! Retrieve the length of string.
                  Update >IN to one character after the parsed word. However, if the parsed string
                  is a null string, do not move >IN.

;

: PARSE          ( char -- addr len )
                  Do the same as PARSE-WORD without skipping the leading char.

>R
SOURCE >IN @ /STRING SCAN instead of SKIP.
OVER SWAP R> SCAN Len.
>R            Addr and length of parsed string.
OVER - DUP     Update >IN to end of string.
R> 0<> - >IN +!

```

```

;
: 'WORD ( -- addr )      Leave on stack the address of the word buffer, which is on top of the dictionary.
                          In F83 'WORD is the same as HERE. They might differ as indicated in 83-Standard.
HERE ;

```

Finally, we get to the most important command **WORD**, which parses the next word in the input buffer and copies the word to the word buffer for the text interpreter to do searching or number conversion. **WORD** will skip over leading delimiters so that words in the input stream can be spaced out to conform to various formatting conventions.

```

: WORD ( char -- addr )  Parse the input stream for char and return a count delimited string in the word
                          buffer at HERE. Note that there is always a blank following the word in the word
                          buffer.
PARSE-WORD               Get the address and the length of the next word in the input stream.
'WORD PLACE              Move the word into the word buffer, with a length byte as the first character.
'WORD DUP COUNT +        The address following the string.
BL SWAP C!                Append a blank at the end of string.
; .

```

10.5. String Commands Defined Using PARSE

A couple of examples are handy here to illustrate the usefulness of these parsing commands:

```

: ( ( -- )              The Forth comment command. The input stream is skipped until a ) is encountered.
                          The enclosed comments are thus ignored by the text interpreter.
ASCII )                 Use ) as the delimiter.
PARSE                   Move >IN to the character after ).
2DROP                   Nothing will be done with the comments. Discard its address and length.
; IMMEDIATE              Declare ( to be immediate so that it will be executed inside a colon definition.

: .( ( -- )             Type the following string on the console during interpretation or compilation.
ASCII )                 Use ) as delimiter.
PARSE                   Parse out the next string upto but not including the ) character.
>TYPE                   With addr and len on stack, type out the string.
;

: >TYPE ( addr len -- ) Same as TYPE. The string is copied to the PAD buffer before outputting for
                          multi-tasking environment.
TUCK PAD SWAP CMOVE     Copy the string to PAD buffer.
PAD SWAP TYPE           Type from the PAD buffer which is private to a task.
;

```

10.6. End of Buffer Condition

A blank character appended to the end of the parsed word in the word buffer is very important to the F83 system. It serves many important functions. One of them is for the number conversion routine to recognize the correct end of a number string. Another function is to help the text interpreter to detect the end of an input stream so that the text interpreter can prepare itself to process the next input stream or command line. For those familiar with the figForth system, there the end of an input stream is artificially terminated by one or more ASCII NUL characters. During console inputting, when a carriage return is received from the keyboard, the input routine appends a NUL at the end of the input stream. When using source texts in disk blocks, each disk buffer has two trailing NUL as the tail of the buffer. These artificial NULs force the interpreter

loop to be terminated in a non-obvious and hard to document fashion. F83 tries to treat the end of line condition explicitly.

When WORD reaches the end of the input stream, the length of the parsed word will be zero. A string without character is then moved into the word buffer. The count byte is zero with a blank character appended to it. This null command, two bytes or one cell long, has a hex value of 2000. In the dictionary, there is a command of this name, whose hex value in the name field is A080. Masking off the MSB in these two bytes (the delimiters of the name field), the real name has a hex value of 2000, exactly the same as the parsed null command. The function of this null command is to turn on the end-of-buffer flag. Seeing that this flag is set, the text interpreter knows it has reached the end of the input stream and terminates the loop, readying itself for the next line of input.

Chapter 11. Text Interpreter

The source code of the text interpreter is in file KERNEL86.BLK, Screens 65 to 69.

11.1. The Operating System of Forth

The text interpreter is the heart of a Forth system. As a matter of fact, the text interpreter is 'the' operating system of Forth, if there is one in Forth. The text interpreter accepts input stream from console and extracts commands from the input stream. It looks up the commands in a dictionary and causes the system to perform the functions designed into these commands. After it successfully carries out the commands, it will come back to the console and ask for another line of commands. If all the commands designed into the dictionary have names similar to English commands commonly used, the Forth text interpreter makes a computer rather intelligent and easy to use, using a computer industry cliché, user friendly.

11.2. Entering the Text Interpreter

The functions of the text interpreter is best traced from the very beginning in the booting up of the Forth system to the point when a command line or input stream is accepted and processed. Instead of explaining all the low level commands first and build up layers of high level commands to reach the top level of the text interpreter, let's try this top-down approach: explaining the functions of the high level commands and then detailing the functions of the modules invoked in the high level command. The most logical command to start is ABORT, which is the starting point of the Forth system and also the point of return whenever an error condition is encountered.

```
DEFER ABORT          Vectored to (ABORT). Re-initialize all the Forth registers and start the text
                    interpreter afresh.

: (ABORT) ( -- )    Unconditional abort routine.
  SP0 @             Get the initial data stack pointer from the user variable SP0.
  SP!               Stuff that pointer into the data stack pointer register of the virtual Forth
                    computer.
  QUIT              Jump to QUIT routine which is the point of return for normal forced termination
                    of execution.
;

: WARM ( -- )      Perform a warm start.
  TRUE              Force an abort.
  ABORT" Warm Start" Abort with a message.
;

: COLD ( -- )      High level cold start.
  BOOT              Execute a user defined bootup definition.
  QUIT              Jump to QUIT, a normal re-start oint.
;

DEFER BOOT          Vectored to a user selected initializing routine. The default boot routine is
                    ABORT.

: QUIT ( -- )      The main Forth loop. Get more input from the console terminal and interpret it.
```

```

Respond with "ok" if every thing is well.
SP0 @ 'TIB !      Initialize the terminal input buffer to address just above the data stack.
BLK OFF          Store a zero in BLK. Force the interpreter to process input from the console
                 terminal.
[COMPILE] [      Store a zero in the variable STATE, forcing the system into the interpretive mode.
BEGIN           Enter the main Forth loop.
RP0 @ RP!       Initialize the return stack pointer.
STATUS         Indicate status of the system. A defer word normally vectored to CR, doing a
                 carriage return.
QUERY          Prompt the user to enter a line of commands on the console and copy this command
                 line to the terminal input buffer
. RUN           Process the command line.
STATE @ NOT     If STATE is zero, the system is n the interpretive mode.
IF ." ok" THEN  Then print the ok message.
AGAIN          The Forth loop is an infinite loop. After one command line is processed, it goes
                 back to ask for another line. It goes on this way forever.
;

: RUN ( -- )    An enhanced INTERPRET. It allows for multiline compilation, enabling you to enter
                 a colon definition that spans over several lines.
STATE @ IF      If STATE is not zero, the system must be in the compiling dictionary.
STATE @ NOT     After compiling one line of source codes, test STATE again.
IF INTERPRET THEN
                 If the system left the compiling mode, then interpret the rest of the line.
                 Otherwise, exit.
ELSE           The state is zero,
INTERPRET       interpret the command line.
THEN ;

```

11.3. INTERPRET

INTERPRET is a beautiful piece of code, a classic example of the simplicity and powerfulness of Forth language in describing complicated computational processes using high level commands. It is worthy of our time to read the code and do our best to gain the fullest understanding of it. The definition of INTERPRET reads:

```

: INTERPRET ( -- )  The Forth interpreter loop. It parses out a word from the input stream. If the
                    word is defined execute it, otherwise convert it to a number and push it on the
                    stack.
BEGIN              Begin the interpret loop.
?STACK            Check for stack underflow or overflow.
DEFINED           Get the next word from the input stream and return its cfa and a flag.
IF EXECUTE        If the word is defined, execute it using the cfa left on stack.
ELSE NUMBER       Otherwise, convert it to a number.
DOUBLE?           Is it a double precision integer?
NOT IF DROP THEN  No. Only a single precision number. Drop the upper half of the double number,
                    preserving only the lower half single integer.
THEN
FALSE             Put up a false flag for DONE?.
DONE?            Is it the end of line?
UNTIL            If we reach end of line here, exit the loop. Otherwise, loop back to interpret
                    the next word.
;

```

DEFINED is a very big command. It first parses a word out of the input stream and places it in the word buffer on the top of the dictionary. It then searches through the dictionary for a command with the same name. If a command is found, its code field address is placed on the data stack followed by a true flag. A valid code field address is then turned over to EXECUTE. EXECUTE executes this command by invoking the appropriate inner interpreter, which we had discussed in the chapter on inner interpreters. DEFINED is discussed in the chapter on vocabulary.

Now, if DEFINED failed to find a command with a matching name, control is passed to NUMBER, which converts the parsed word to a double precision number on the data stack. If a period was embedded in the number string, which causes DPL to differ from -1, the command DOUBLE? returns a true flag and the double number remain on the stack. Otherwise, the higher half of the double number is dropped from the stack and only a single precision number is left on the stack.

At the beginning of the loop, the data stack is checked for overflow or underflow by ?STACK. If the stack is ok, control falls into DEFINED to process the next word in the input stream. If a stack error condition is encountered, the system is forced into ABORT to start all over again. If an error condition is encountered during the number conversion process, an abort is also forced. These are the two conditions for abnormal exit from the INTERPRET loop.

11.4. DONE? and X

At the end of the INTERPRET loop, DONE? is executed to test the end-of-buffer condition. If it reached the end of the input buffer, the loop would be terminated and the control falls into the outer Forth loop in QUIT. Otherwise, the interpreter will loop back to parse and execute the next word in the input buffer.

A flow chart of this chain of activities might be helpful in visualizing the sequence of events when the Forth system is cranking in full steam, as shown in Fig. 12.1.

A number of loose ends have to be patched before we finish this chapter.

```

: ?STACK ( -- )           Check for data stack underflow or overflow. Abort if any of the error
                           conditions occurred.
  SP@                     Get the current data stack pointer.
  SP0 @ SWAP U<          If the stack underflowed,
  ABORT" Stack Underflow" Abort.
  SP@ PAD U<             If the stack grows too close to the top of the dictionary,
  ABORT" Stack Overflow" Abort also.
  ;                       Otherwise, return normally.

: DONE? ( n -- f )       Return a true flag if the inputstream is exhausted or the STATE doesn't match
                           with the current state.
  STATE @ <>             Is the state flag left on stack the same as that in STATE?
  END? @ OR              Or the end of line? Leave the or'ed flag on stack.
  END? OFF               Turn off the end-of-buffer flag to let the interpreter get a new line of command
                           and start over.
  ;

```

In F83 systems before Version 2.0, the end-of-buffer condition is detected and the END? flag is set by a command with a null string as its name. This null command was defined using a pseudo name of X and later patched to null. When the input stream is exhausted, the last word parsed out by WORD is this null command and it tells the text interpreter to stop processing the input buffer.

This technique had been used in most Forth systems including figForth . In F83 Version 2.0 and later, the end-of- buffer condition is detected and the END? flag is set in the word FIND; therefore, this mysterious null command is eliminated and the text interpreter is in much better shape. The discussion on the null command X is included here for completeness and for users with older versions of F83.

```
: X ( -- )           The null word to flag end-of-buffer and to terminate the interpreter loop.
  END? ON           Turn on the end-of-buffer flag in the user variable END?.
;

HEX A080 LAST @ !
IMMEDIATE  DECIMAL
```

The real name of X in the Forth dictionary is a null string, with a character count of 0 and a blank character. This null string is returned by WORD to the word buffer when the end of the input stream is reached. The contents of the name field of this null command is A080 in hex, with the MSB's in both bytes set as name field delimiters. As we reach the end of the input stream, this null command is returned by WORD and executed. It turns on the END? flag and terminates the interpret loop. Explicitly terminating the interpret loop at the end of input stream makes the definition of INTERPRET comprehensible. Another advantage is that the end-of-buffer condition does not have to be artificially synthesized by appending a NUL character at the end of the input line form the console or at the end of every disk buffer (as done in figForth), which can be easily corrupted and causes the Forth system to behave erratically.

Chapter 12. Compiler

The source code discussed here is in the file KERNEL86.BLK, Screens 70, and 76 to 78.

12.1. The Colon Definitions

Colon commands are the most prevailing type of commands in Forth. A colon command has a variable length parameter field where a list of execution addresses is stored. Functionally, a colon command is the equivalence of the sequence of commands whose execution addresses are stored in its parameter field. When the colon command is invoked, this sequence of commands are executed by the address interpreter. Comparing to other high level languages, a Forth colon command is similar to a procedure or a subroutine, which contains a sequence of procedures or subroutine calls:

Forth Colon Definition	FORTRAN Subroutine
: Z	SUBROUTINE Z
A	CALL A
B	CALL B
C	CALL C
D	CALL D
;	RETURN

where A, B, C, and D are other pre-defined commands in Forth or subroutines in FORTRAN.

Colon commands allow us to build higher level functions from existing modules. The building process can continue on until the final colon command becomes the solution to our programming problem.

What, then, is the advantage of colon commands over the procedures or subroutines in other languages, since they serve very much the same purposes? The answer is that although a Forth colon command is the same as a procedure or a subroutine in functionality, it serves the functions more efficiently and it can be debugged more easily. The result is a solution or a program of much higher quality at lower cost. We can summarize the advantages of Forth colon commands in two words: efficiency and modularity.

Efficiency

Efficiency in computer programming has three aspects: memory utilization, execution speed, and programming productivity. Forth colon commands excel in all these aspects as compared to other high level languages. Each reference to another pre-compiled command in Forth costs two bytes in memory, the execution address of the referred command. The calling of a command and

returning to the caller in Forth is also very fast due to the efficiency in the inner interpreters, especially in hosts of good architecture design. In executing high level language programs, by far the largest overhead is doing subroutine calls and returns, with a host of parameters to be passed between the caller and the callee. Since Forth uses the data stack to pass all the parameters between commands, the overhead in parameter passing is cut to the minimum. Ease in testing and debugging greatly improve the productivity of programmers using Forth as software development tool.

Modularity

Forth commands are true modules because they are memory resident and individually executable routines. Once a command is defined and compiled into the dictionary, it is immediately available for execution and for compiling into other commands. In other languages, procedures and subroutines are modules only in the abstract sense. They have to be compiled and linked to a mainline program before they can be invoked to do any useful work, within the context of the mainline program. In the example above, the commands A, B, C, D, and Z are all executable modules in Forth. In FORTRAN, none of the subroutines A, B, C, D, and Z are executable. They are only modules on paper.

Why is true modularity so important? It greatly simplifies the testing and debugging of a program of large size, because individual modules can be thoroughly tested before being integrated into modules at a higher level of construction. In debugging a conventional program, the most valuable tool is the break point facility, allowing you to stop the program at selected break points to examine the progress of operations. In Forth, each command can be tested at the interpreter level with a natural break point at its end, eliminating the need of a debugger.

Due to the small overhead in nesting commands, Forth encourages the breaking of large modules into many small modules which can be tested thoroughly and separately. This modularization gives us a chance to prove the correctness of a large program by proving the correctness of each component and the correctness of their interconnections.

12.2. Colon and Semicolon

So much for propaganda. Let's now look at how the colon compiler itself is defined.

```
: : ( -- )          Define a colon definition. The new definition is hidden until it is completed.
                        The runtime code for : adds a nesting level.
!CSP                Store the current stack pointer in a variable CSP for error checking at the end
                        of a definition. Normal compilation should not affect the depth of the data stack.
                        I stack depth is changed, it is a potential error condition.
CURRENT @ CONTEXT ! Select the current vocabulary as the context vocabulary to restore the environment
                        of compilation.
```

```

CREATE          Create a header in the dictionary using the name following
:.
HIDE           Smudge the name field of the new header so it is hidden from dictionary searches.
]             Enter the colon definition compiler to start constructing the list of execution
              addresses in the parameter field.
;USES        Insert the following code routine address into the code field of the new
              definition, making it a colon definition.
NEST ,        Compile the address of the address interpreter NEST here so that it can be put
              into the code field of new colon definitions.
;
: ; ( -- )    Terminate a colon definition. It compiles the runtime code of UNNEST to remove
              a nesting level and changes STATE to terminate compilation.
?CSP         Check the current stack pointer with the contents of CSP.  If they are not the
              same, abort.
COMPILE UNNEST  Compile UNNEST at the end of the new colon definition to force execution to return
              to the caller.
REVEAL       Unsmudge the name field of the new colon definition, making it available for
              dictionary searches.
[COMPILE] [    Compile [ here to terminate the compilation of the new colon definition.
; IMMEDIATE   ; must be executed in the compiling state.  It must be declared immediate.

```

The compilation process is very similar to the interpreting process in Forth. Instead of executing the word parsed out of the input stream, the execution address of the command is added to the top of the dictionary, where we are building the parameter field of a new colon command. If the word is a number, instead of leaving the number on the data stack, it is compiled into the new command as a literal so that when the new command is eventually executed, the same number can be retrieved and put back on the stack. The compiler is embodied in the command], which is the twin brother of INTERPRET, because they share lots of common tools and structure. In figForth and many older Forth systems, the compiling functions are actually rolled into INTERPRET as one single piece of command. The good doctors in the Forth Standard Team decided that it is unsightly that the Siamese twin should share their umbilical cord forever, and cut them loose. The compiling functions are then welded into]. F83 has no choice but to follow the doctor's order.

12.3. The Compiler Loop

```

: ] ( -- )    The compiling loop. It sets the compiling flag in STATE, and parses the next
              word out of the input stream. If the word is found in the dictionary, it is either
              executed or compiled depending on whether it is immediate or not. If it is a
              number, it is compiled into the dictionary as either a single or a double integer
              literal. Continue until the input stream is exhausted.

STATE ON      Set the flag in STATE and enter the compiling mode.
BEGIN        Loop to scan the input stream.
?STACK       Check for stack over- or underflow.
DEFINED      Parse out the next word and search the dictionary.
DUP IF       If it is found in the dictionary,
  0> IF      and if it is an immediate word,
    EXECUTE  then execute it.
  ELSE      If it is not an immediate word, compile its cfa into the dictionary.
  THEN
ELSE        It is not a word in the dictionary.
DROP       Discard the flag left by DEFINED.
NUMBER     Convert the word to a number.
DOUBLE? IF If a punctuation is detected in the string,
  [COMPILE] DLITERAL compile the double integer literal.
ELSE      No punctuation in the string.
DROP     Discard the upper half of the converted double integer,
  [COMPILE] LITERAL and compile the single integer literal.
THEN
THEN
TRUE      The compiling flag.
DONE?    If the input stream is exhausted, leave a true flag to exit the compiling loop.

```



```
UNTIL
;
```

Otherwise, loop back to compile the next word.

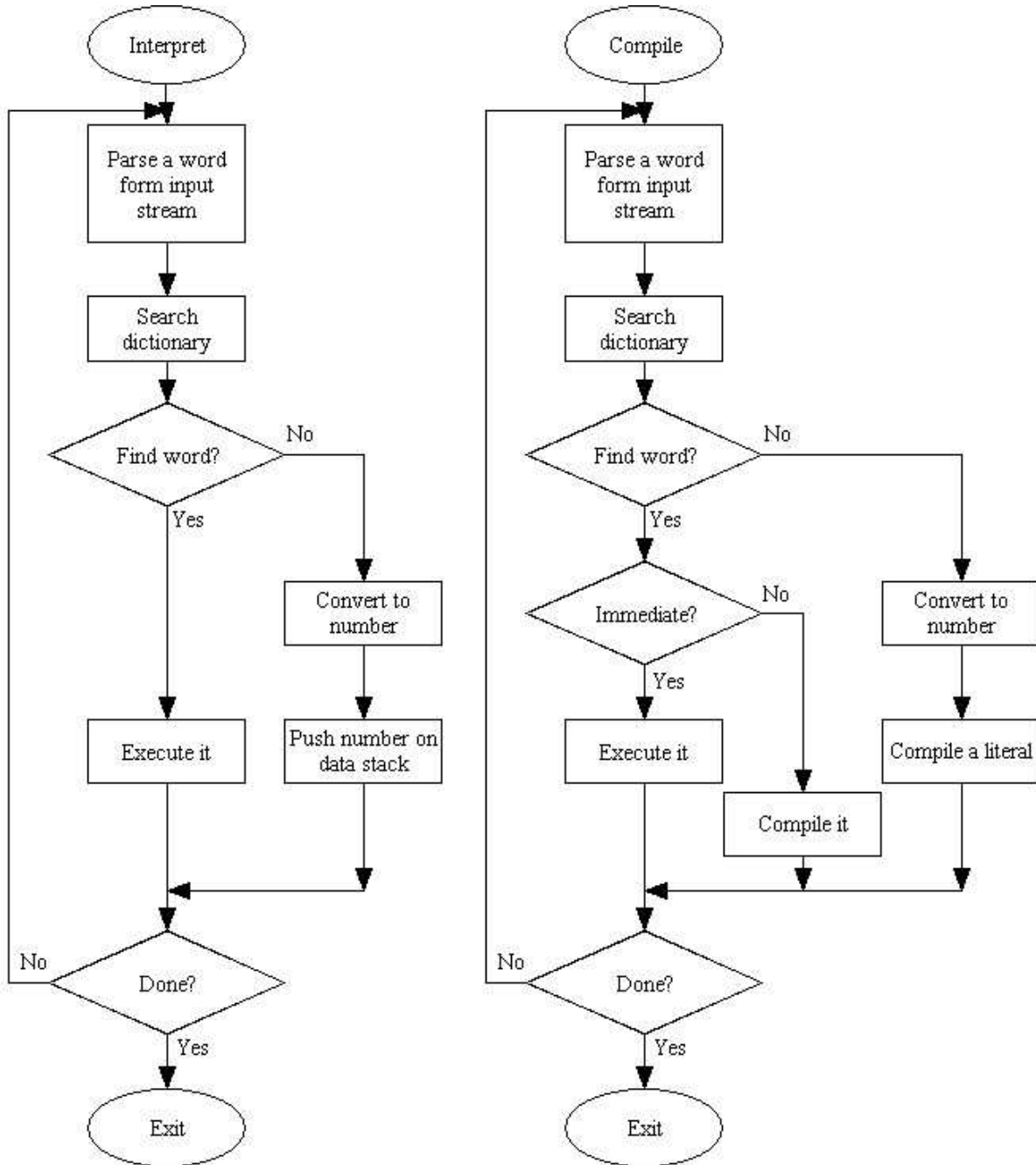

Figure 12.1 The interpreter and the compiler

```
: [ ( -- )
STATE OFF
; IMMEDIATE
```

Stop compiling and start interpreting.
 Turn off the compiling flag in STATE, forcing the Forth system into the interpreting mode.
 It is declared immediate so that its effect can be revealed even during compilation.

12.4. Low Level Supporting Commands

We have presented the compiler at the highest level. There are a long list of supporting commands behind these compiler commands to realize all the functions required in the compilation processes. Let's try to give recognition to all these unsung heroes.

```
VARIABLE DP          The user variable where the address of the first free memory above the dictionary
                    is stored. It helps the compiler to keep track of its memory.

: HERE ( -- addr )  Return the address above the dictionary, the free memory available for the
                    compiler.

DP @ ;

: 'WORD ( -- addr ) Return the address of the word buffer, same as HERE.
HERE ;

: ALLOT ( n -- )    Allocate more space on the dictionary by moving the DP pointer.
DP +! ;

: , ( n -- )        Copy the top stack item to the top of the dictionary. This is the compiler in
                    its most primitive form.
HERE !              Compile n to dictionary.
2 ALLOT             Move the DP pointer passing the item just compiled.
;

: C, ( byte -- )    Compile one byte to the dictionary.
HERE C!             Compile one byte.
1 ALLOT             Move DP.
;

: COMPILE ( -- )    Compile the next word in a colon definition to the dictionary when this definition
                    is executed. It can only be used inside a colon definition.
R>                  The address of the next word is on the top of the return stack. Retrieve it.
DUP 2+ >R           Increment the top of return stack so that the next word will not be executed.
@                   Get the execution address of the next word.
,                   Compile it to the dictionary.
;

: IMMEDIATE ( -- )  Mark the most recently defined word to make it an immediate word. An immediate
                    word will not be compiled by the ] compiler but will be executed.
64                  The precedence bit in the first byte of the name field.
LAST @              Get the name field address of the most recently defined word from the variable
                    LAST.
CTOGGLE             Set the precedence bit in the name field, marking the word immediate.
;
```

12.5. Immediate Commands

Two good examples of immediate commands are LITERAL and DLITERAL in]. They are used to compile literal numbers in a colon command. They are needed because the address interpreter treats the data stored in a colon command as execution addresses. If we need to put a number on the stack between two addresses, we cannot simply compile the number in-line, because then the number will be interpreted as an address. In-line literal numbers in a colon command must be preceded by a special runtime command (LIT), which will push the following literal to the stack when executed. To compile a number into a colon command, LITERAL is executed immediately to compile first (LIT) and then the number, building the correct literal structure in the colon command.

```

: LITERAL ( n -- )      Compile the single integer from the stack as a literal.
  COMPILE (LIT)         First compile the runtime routine (LIT).
  ,                     Then compile the number.
; IMMEDIATE             Make it an immediate word.

: DLITERAL ( d -- )    Compile the double integer from the stack as a double literal.
  SWAP                  Reverse the order of the double integer so that the right double integer will
                        be pushed on the stack when executed.
  [COMPILE] LITERAL     Do the literal compilation not now but when DLITERAL is executed. To force the
                        compilation of LITERAL, it must be preceded by [COMPILE].
  [COMPILE] LITERAL     Force compilation of the upper half of the double literal.
; IMMEDIATE

```

Words in a colon definition are normally compiled. Immediate commands are not compiled but executed immediately. To compile an immediate command like other commands in a colon command, the immediate command must be preceded by [COMPILE]. To compile a command only when the command is executed, the command is preceded by COMPILE. It is rather confusing for a new comer to Forth. But, you have to remember, building compiler is not an easy task for everybody. These commands encompass activities in the designing of a compiler to build commands which will have the correct behavior at runtime. You will have to go to a graduate school of computer sciences to hear these topics discussed only peripherally. To understand these concepts, you have to read more code in the Forth compiler and let it gradually sink in. Or, try to write a few compiler routines yourself and see how they function.

I can offer you one more hint: immediate commands are the equivalents of the compiler directives or assembly directives in the conventional programming languages. They may or may not generate executable code in the program, but they control the process of compilation or assembly and they are executed during the compilation or assembly, but not when the final codes are executed. We will discuss more of these immediate commands in the following chapter.

```

: [COMPILE] ( -- )      Force compilation of the following immediate word.
  ' ( tick )           Find the execution address of the next word.
  , ( comma )          Compile it.
; IMMEDIATE             It must be executed immediately.

```

[COMPILE] cannot wait to let the] compiler to find the address it needs, because] might have to execute the next command. [COMPILE] is executed inside the compiler loop and it has to find the address of the next command immediately to compile it. Therefore, [COMPILE] uses a special dictionary searching command ' (tick) to do the dictionary search:

```

: ' ( -- cfa )         Return the execution address of the next word. If the word cannot be found, abort.
  DEFINED              Parse the next word and search the dictionary for it.
  0=                   If the search failed,
  ?MISSING             Abort with an appropriate message.

;                       If the word is found, return its code field address.

: ?MISSING ( f -- )    Tell the user the word does not exist and abort.
  IF                  The flag is true,
  'WORD COUNT TYPE     Type the word failed to match.
  TRUE ABORT" ?"       Abort with a very mild message.
  THEN                 Return if the flag is false.
;

```

Chapter 13. Structures in Colon Definitions

The source code discussed in this chapter is in KERNEL86.BLK, Screens 70-71, and 74-75.

13.1. Compiler Directives

We have discussed in great detail the contents and the functions of the colon command compiler which compiles colon commands, and the address interpreter which executes colon command as a list of execution addresses. If that is all, the usefulness of colon commands is severely limited, as they will not be able to cope with the wide variety of situations a programmer must solve using his computer. Very few problems can be solved by linearly strung procedures or commands. We need the capability of altering the execution sequence on the fly, depending upon the results obtained in runtime. We need the capability to compile and use different types of data and data structures, which are used to encode input/output information and to hold intermediate information during processing. Compiler directives are used to allow you to specify explicitly alternate or repetitive execution sequence and compile special data structures inside a colon command. Compiler directives are also called immediate commands because they have to be executed immediately during compilation so that special structures can be built inside a colon command. Immediate commands can be distinguished from normal commands by the fact that a bit, the precedence bit, in the first byte of the name field is set.

The compiler loop] can compile normal, non-immediate commands and single or double integer literals. However, it incorporates an extremely powerful hook to take care of any special compiling conditions in the form of immediate commands. Whenever we have a situation that the compiler] is not able to handle, we will design an immediate command to do whatever is necessary to take care of the situation and then let the compiler] continue its normal compilation.

A few examples were shown in the chapter on the colon compiler. In fact, literals are handled this way. When the compiler fails to locate a command in the dictionary, it converts the word into a number and asks LITERAL or DLITERAL, two immediate commands, to compile the numbers into the dictionary in the form of two data types, single integer literal or double integer literal. This way, numbers can be compiled into colon commands, in-line with the execution addresses which are the default data type in colon commands.

There are other data types and different methods of interpreting them within the context of a colon command. F83 is very rich in these special commands, for the convenience of you the user. Let's look at them closely.

13.2. Compiling Numeric Data Structures

Two data types were taken care of: the single integer literal and the double integer literal. The immediate commands which compile them are LITERAL and DLITERAL. The runtime commands which interprets them, pushing the number on the data stack, is (LIT).

Two immediate commands are provided to compile ASCII codes. They also use (LIT) to interpret the compiled character literals:

```
: ASCII ( -- char )      Compile the next character in the input stream as an ASCII character literal.
BL WORD                 Parse out the next character.
1+ C@                   Get the ASCII code of this character from the word buffer.
STATE @                 Are we in the compiling state?
IF [COMPILE] LITERAL    Yes. Compile the character as a single integer literal. However, technically
                        it is a character literal.
THEN                    If interpreting, just leave the character on stack.
; IMMEDIATE

: CONTROL ( -- char)    Compile the next character in the input stream as a control character literal.
                        The character must be upper case.
BL WORD                 Get the next character.
1+ C@                   Get its ASCII code.
ASCII @                 Offset between the control character and the upper case character.
-                       Control ASCII code.
STATE @                 If compiling,
IF [COMPILE] LITERAL    Compile the control code as a literal.
THEN                    Leave the character on stack if interpreting.
; IMMEDIATE
```

We can always lookup the ASCII table and use the character codes directly in colon commands. ASCII and CONTROL, however, make very clear documentation to the intention of the programmer. Using these commands to invoke ASCII codes explicitly is highly recommended.

Ever heard of address literals? Well, there are really such things. Its usefulness has been demonstrated in many applications in which we want to locate a command in the dictionary in runtime. An example is to find the address of a colon command so that we can jump into the middle of it. The reason of doing so is not obvious and certainly is not orthodox Forth practice. Anyway, if you need the address of another command inside a colon command, the command ['] is the one to use.

```
: ['] ( -- )           Compile the address of the next word as a literal. At runtime, return that address
                        to the stack.
' ( tick )             Find the execution address of the next word in the input stream.
[COMPILE] LITERAL      Compile the address as a literal.
; IMMEDIATE
```

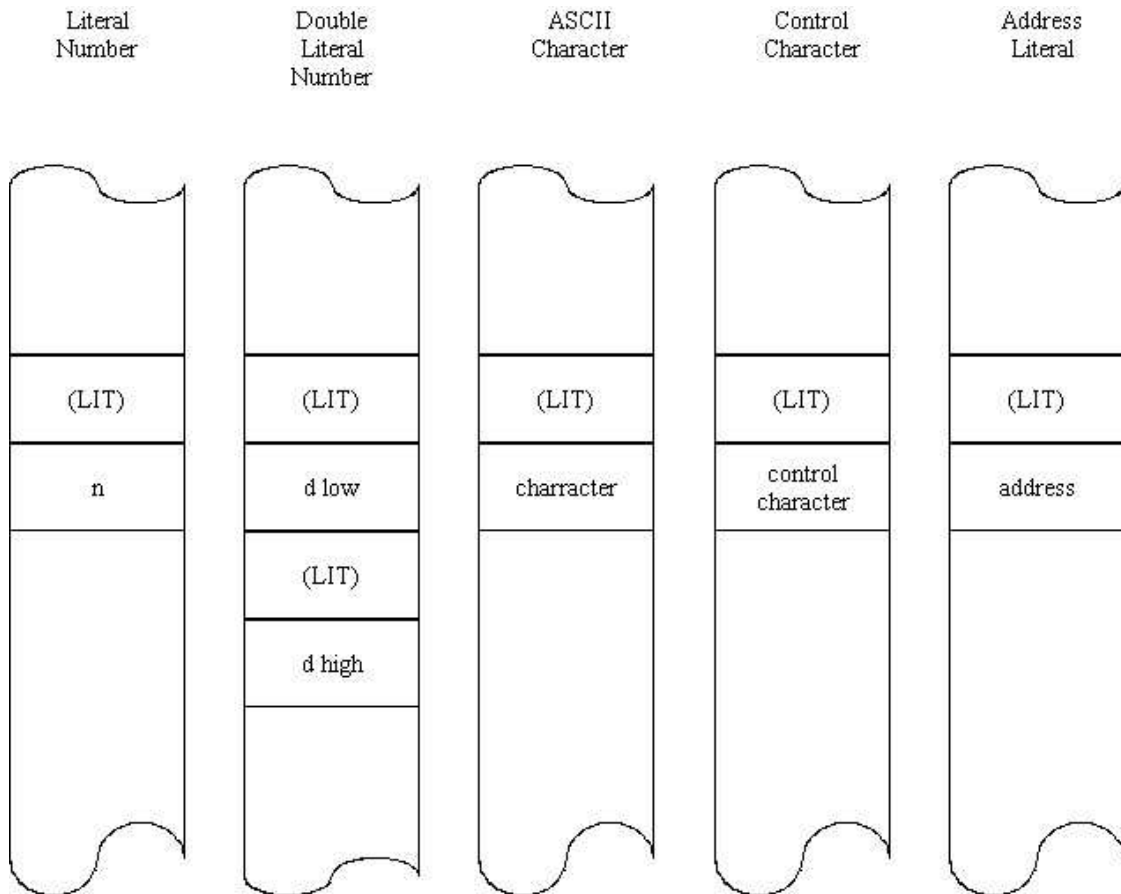

Figure 13.1 Numeric data structures.

13.3. Compiling String Literals

String literals are very useful data type. They can be used to compile messages in a colon command. At runtime, the message will be typed out on the console, creating a friendly environment for the end users.

```

: (") ( -- addr len ) Return the address and the length of an in-line string.
R> Address of the in-line string compiled immediately after (").
COUNT Get the addr and len of the string.
2DUP + The address of the executable code after the string.
EVEN Align to cell boundary.
>R Replace it on the return stack to continue the execution process.
;

: (".) ( -- ) Type out the in-line string and continue executing the word after the string.
R> Address of the in-line string.
COUNT Addr and len.
2DUP + EVEN >R Replace the address of the next word to be executed.
TYPE Output the string to console.
;

: ," ( -- ) Compile the following string to the dictionary.
ASCII " Use " as the delimiter of the string.
PARSE Parse the string out.
TUCK 'WORD PLACE Copy the string into the word buffer, just the right place to compile this string.
1+ ALLOT ALIGN All we have to do is to move the DP pointer to include the string i the dictionary.
;

```

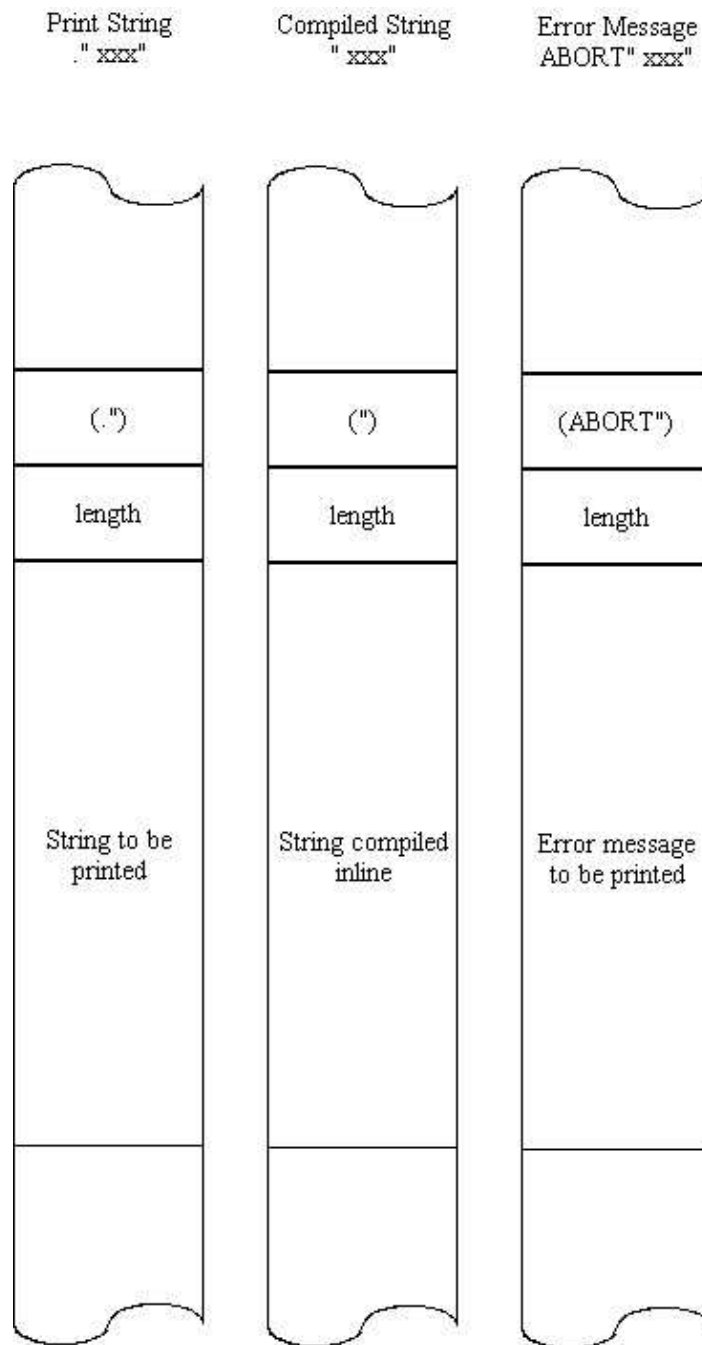

Figure 13.2 The string literals.

```

: ." ( -- )
  COMPILER (.)
  ,
; IMMEDIATE

: " ( -- )
  COMPILER (")
  ,
; IMMEDIATE

```

Compile the following string to be typed out later.
 Compile the runtime code (".") before the string so that the string will be interpreted correctly.
 Compile the string into the dictionary.
 This is a compiler directive. Declare it to be immediate.

Compile the string. At runtime, return its address and length.
 Compile the runtime routine (").
 Compile the string after (").
 Must be immediate.

An important command also using string literals is the command `ABORT"`. It forces the Forth system to return to the text interpreter with a clean state to start over again. It can also print out a message explaining why it has to take such a drastic measure to help you figure out what happened in the computer at run time.

```

: (ABORT") ( f -- )      The runtime routine compiled by ABORT".
R@ COUNT                Get the addr and len of the following string literal.
ROT                     Move the flag to the top of stack.
?ERROR                  Turn over to ?ERROR to process the error condition.
R> COUNT + EVEN >R      Move the top of return stack to the word after the string, to resume execution
                        as the error condition was not true.
;

: ABORT" ( f -- )       If the flag is true, issue an error message and quit.
COMPILE (ABORT")        Compile runtime routine.
."                       Compile the message.
; IMMEDIATE

DEFER ?ERROR            Vectored to (?ERROR).

: (?ERROR) ( addr len f -- )
-- )                    If the flag is true, execute WHERE to store useful debugging data, type a message,
IF                       and quit.
>R >R                   If the flag is true, prepare to quit.
SP0 @ SP!               Save the string parameters.
PRINTING OFF            Initialize the data stack.
BLK @ IF                Turn off the printer.
>IN @ BLK @ WHERE       If BLK is not zero, we are processing data from a disk block.
                        Save the character pointer to the input buffer and the block number and call WHERE
                        to provide debugging aids.

THEN
R> R>                   Restore the string parameters.
SPACE TYPE SPACE        Print the abort message.
QUIT                    Restart the text interpreter.
ELSE                     No error condition.
2DROP                   Clear the data stack.
THEN                     ;

DEFER WHERE             WHERE is vectored to an editor routine (WHERE) to display the block of source
                        with the cursor pointing to the word that causes the abort.

```

There are other data structures that can be compiled into the colon commands. However, many of them can be taken care of by variables and arrays derived from variables. Other recurring structures may be handled by the `CREATE-DOES>` technique.

13.4. Compiling Control Structures

Forth is a structured language. A structured language has provisions for you to do two things: successive refinement to decompose a problem into smaller parts hierarchically, and building modules with control structures. Control structures, or simply structures, are segments of a program or groups of program statements which have only one entry and one exit. The one-entry-one-exit property of control structures allows the structures to be stacked linearly to form larger segments which can be built into other structures at a higher level. Execution can take alternate paths or repeat a portion of the path only within a structure. Very complicated high level structures can be built on simple structures, enabling programmers to deal with real life problems efficiently.

In a previous chapter, I emphasized that Forth is a truly modular language because the commands in Forth are true modules, which can be independently executed and compiled, quite different from modules in other languages which can function only within the context of a mainline program. Forth commands are also structures, with one entry and one exit. There are some exceptions when error conditions are encountered. In these cases, execution is forced to abort to the text interpreter. Forth commands, as structures, can be stacked linearly together to form higher level structures, which are basically the colon commands. Besides linearly stacked structures, Forth provides a special set of commands which allows you to build other more sophisticated control structures inside colon commands so that alternate paths can be chosen and segments can be repeated in runtime. These structure building commands are all immediate commands, because they have to perform extra work to build the desired structures correctly while the compiler is running.

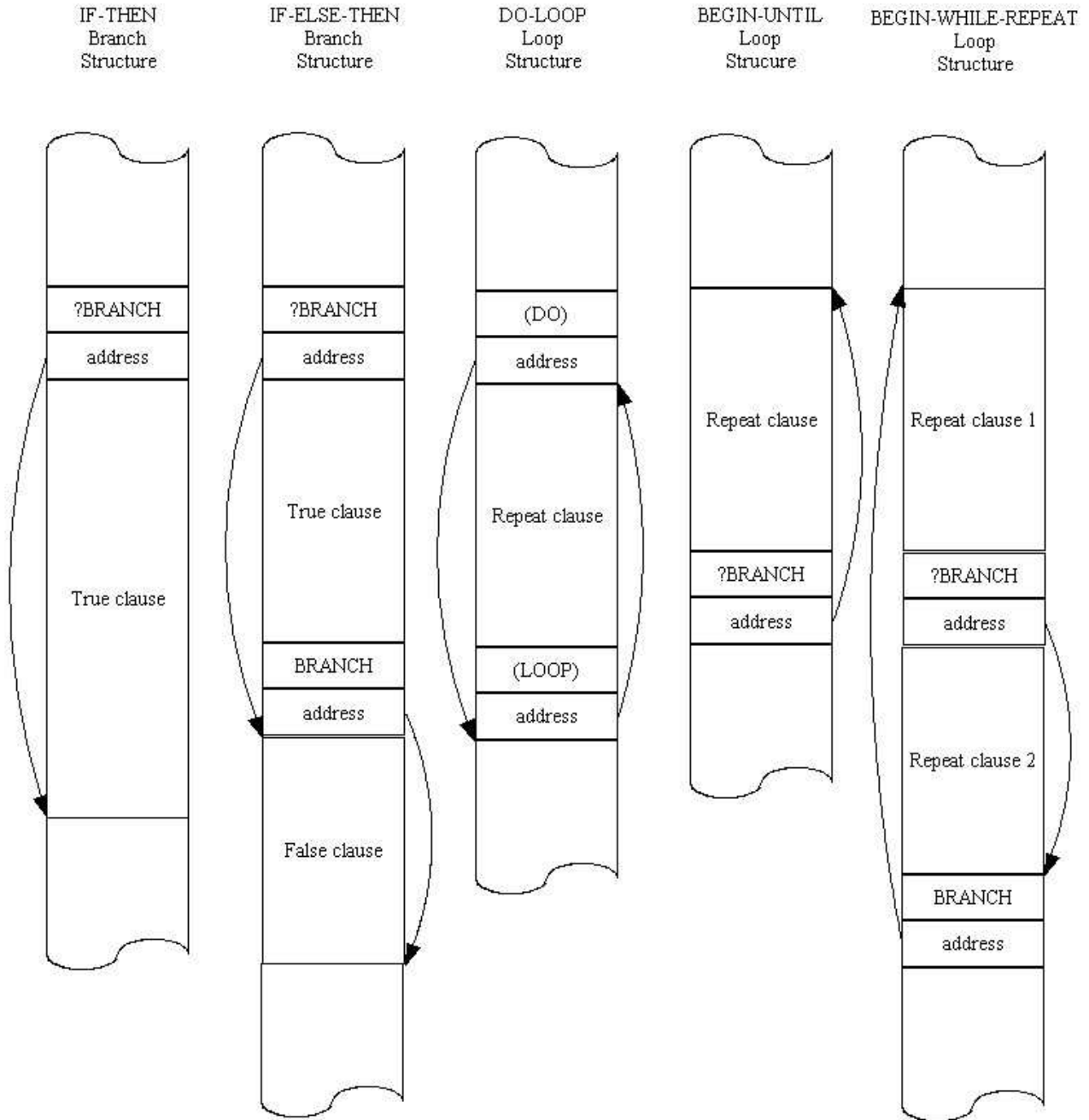

Figure 13.3. The control structures

The set of structure building commands in F83 are listed here according to the syntax of their usages:

```

IF <true clause> THEN
IF <true clause> ELSE <>false clause> THEN
BEGIN <repeat clause> UNTIL
BEGIN <repeat clause> AGAIN
BEGIN <repeat clause 1> WHILE <repeat clause 2> REPEAT
DO <repeat clause> LOOP
DO <repeat clause> +LOOP
?DO <repeat clause> LOOP
?DO <repeat clause> +LOOP

```

Inside the do-loops, the optional commands LEAVE and ?LEAVE can be used to force the termination of the loop.

13.5. Address Calculation for Control Structures

In the chapter on the kernel commands, we have already discussed the low level commands which change the execution sequence in runtime. What the structure building commands have to do is to compile these runtime routines into the colon command with additional branching addresses so that the execution sequence in runtime can be changed according to pre-defined rules. Thus a group of supporting commands are needed to calculate the branching addresses during compilation.

```

: ?CONDITION ( f -- )      Compile time error checking. If the flag is false, abort.
NOT                          Invert the flag.
ABORT " Conditionals Wrong"  Abort with a message.
;                             This simple error checking is adequate for most situations.

: >MARK ( -- addr )       Mark the point of a forward branch by saving its address on stack.
HERE                          Addr in which the forward branching address will be placed.
0 ,                            Compile a dummy address for the moment.
;

: >RESOLVE ( addr -- )    Resolve a forward branch.
HERE                          This is the address to jump to.
SWAP !                         Store this address in the memory addr where the forward jump originates.
;

: <MARK ( -- addr )       Set up a backward branch by leaving the current address on stack.
HERE                          This is the address the backward branch will jump to.
;

: <RESOLVE ( addr -- )    Resolve a backward branch.
, ;                             Compile the backward jump address at this point.

: ?>MARK ( -- f addr )    Set up a forward branch with error checking.
TRUE                          Put up a true flag for error checking.
>MARK ;                        Do the work.

: ?>RESOLVE ( f addr -- ) Resolve an backward branch with error checking.
SWAP ?CONDITION              Check conditional error first.
>RESOLVE ;                    Then resolve the forward branch.

: ?<MARK ( -- f addr )    Set up a backward branch with error checking.
TRUE                          The flag for error checking.
<MARK ;                       Backward jump address.

: ?<RESOLVE ( f addr -- ) Resolve a backward branch with error checking.
SWAP ?CONDITION              Error checking.
<RESOLVE ;                   Resolve the backward branching.

```

Error checking is a valuable service to you to make sure that you have laid down the control structures correctly. Structure commands not properly paired are frequent causes of system crashes, because execution can be steered to an unknown address.

13.6. Control Structure Compiler Directives

Here come the real heroes that compile the control structures in colon commands:

```

: IF ( -- f addr )      Set up the IF-ELSE-THEN structure.
  COMPILER ?BRANCH      Conditional branch.
  ?>MARK                Set up forward branch.
; IMMEDIATE

: ELSE ( f1 addr1 -- f2 addr2 )  Resolve the forward branch from IF and set up forward branch to THEN.
  COMPILER ?BRANCH      Unconditional branch.
  ?>MARK                Set up flag and address to jump to THEN.
  2SWAP ?>RESOLVE       Resolve the jump address at IF.
; IMMEDIATE

: THEN ( f addr -- )      Resolve the forward jump from either IF or ELSE.
  ?>RESOLVE             Resolve the jump address.
; IMMEDIATE

: BEGIN ( -- f addr )    Mark the address for backward branching.
  ?<MARK                ; IMMEDIATE

: UNTIL ( f addr -- )    Compile a conditional branch to BEGIN.
  COMPILER ?BRANCH      Compile the conditional branch runtime routine here.
  ?<RESOLVE             Put the address of BEGIN here to close the loop.
; IMMEDIATE

: AGAIN ( f addr -- )    Compile an unconditional branch to BEGIN.
  COMPILER ?BRANCH      Unconditional branch.
  ?<RESOLVE             Address of BEGIN.
; IMMEDIATE

: WHILE ( -- f addr )    Compile a conditional exit in the BEGIN-WHILE-REPEAT loop.
  [COMPILER] IF         Functionally, WHILE is identical to IF. To execute IF when WHILE is called, you
;                          have to use [COMPILER] to override the immediate effect of IF.

: REPEAT ( f1 addr1 f2 addr2 -- )  Compile an unconditional branch to addr1 left by BEGIN, and resolve the forward
  2SWAP                 branch for WHILE at addr2.
  [COMPILER] AGAIN      Get f1 and addr1 to top of stack.
  [COMPILER] THEN       Use AGAIN to compile the unconditional branch back to BEGIN.
; IMMEDIATE             Since WHILE is identical to IF, we can use THEN to resolve its forward branch.

: DO ( f addr -- )       Compile the header of a do-loop.
  COMPILER (DO)         Put the runtime (DO) here.
  ?>MARK                (DO) needs the address after LOOP, making it look like a forward branching for
;                          a real backward branching.
; IMMEDIATE

: ?DO ( f addr -- )      Compile the header for ?DO-LOOP.
  COMPILER (?DO)        ; IMMEDIATE
  ?>MARK

: LOOP ( f addr -- )     Complete the do-loop.
  COMPILER (LOOP)       Compile the runtime routine here.
  2DUP 2+ ?<RESOLVE     The backward branch address is 2 bytes after (DO), because (DO) needs two bytes
  ?>RESOLVE             to store the address after (LOOP), in case LEAVE needs it.
; IMMEDIATE             Put the address after (LOOP) to the memory just after (DO).

: +LOOP ( f addr -- )    Compile the ending of the +loop.
  COMPILER (+LOOP)      ; IMMEDIATE
  2DUP 2+ ?<RESOLVE
  ?>RESOLVE

: LEAVE ( -- )           Compile (LEAVE).
  COMPILER (LEAVE)      ; IMMEDIATE

: ?LEAVE ( -- )         Compile conditional leave.
  COMPILER (?LEAVE)    ; IMMEDIATE

```

These structure commands look very simple and indeed they are. All they have to do is to pick and compile the right runtime routine and resolve the branching addresses. The runtime routines

know what to do with the branching addresses and change the execution sequence if necessary. These branching addresses can be considered as special address literals, different from the normal execution addresses compiled by the] compiler.

As it is evident in the definitions of these control structure commands, these commands must be used in pairs, and they can be considered as the delimiters for structures in the colon command, clearly indicating the entry points and the exit points of the structures. IF must be followed by THEN. DO must be paired with either LOOP or +LOOP. BEGIN must be paired with UNTIL, AGAIN, or REPEAT. Structures can be nested but can not be overlapped. If the structures are overlapping, the system will behave erratically if not crashed.

The error checking in compiling the structures in F83 is not as extensive as that in the figForth model, in which different types of structures are assigned different error checking numbers instead of a true-false flag. figForth prohibits the compiling of improperly nested structures. Nevertheless, F83 is better than those earlier Forth systems without any error checking on the control structures. If you want speed in compilation, you can strip out the error checking in F83 by using >MARK in place of ?>MARK, etc., and change all the 2DUP to DUP. Then you are entirely on your own.

Part III. Utilities in F83 System

Chapter 14. The MS-DOS Files

The source code managing files in the F83 system is scattered in Screens 51 and 57 in KERNEL86.BLK and also in Screens 7 to 12 in EXTEND86.BLK. Some of them were discussed in the chapter on the virtual memory.

14.1. CP/M-DOS File Primitive Commands

The DOS file management system consists of a set of commands in the DOS vocabulary that access the BDOS functions of the CP/M-DOS operating system, such as creating, opening, and deleting files. There is also a command that parses a string and creates a file control block (FCB). A very useful command SAVE is also provided to save the contents of memory as an executable DOS file. A number of commands were also defined in the basic F83 system which are used to access the default file defined by the FCB1 control block.

```
VOCABULARY DOS          All the DOS words are put in this vocabulary. For CP/M systems, its name is CP/M,
                        of course.
DOS DEFINITIONS        Make DOS the current vocabulary so that all subsequent words will be added to
                        this vocabulary.
CREATE FCB1 B/FCB ALLOT Allocate space for the first FCB block of the current file.
CREATE FCB2 B/FCB ALLOT Allocate space for the second FCB block of the in-file.

: CLR-FCB ( fcb -- )   Initialize the specified FCB.
  DUP B/FCB ERASE      Clear the FCB to nulls.
  1+ 11 BLANK          Initialize the file name and extension to blanks.
;
```

The following commands are simply BDOS functions with Forth names. Descriptive names make the Forth programs or commands more readable.

```
: RESET ( -- )        0 13 BDOS DROP ;

: CLOSE ( fcb -- )    Close the given file and report errors.
  16 BDOS              Call BDOS to close the file.
  DOS-ERR?            If there is error,
  ABORT" Close error" report it.
;

: SEARCH0 ( fcb -- n )
  17 BDOS ;

: SEARCH ( fcb -- n )
  18 BDOS ;

: DELETE ( fcb -- n )
  19 BDOS ;
```

```

: READ ( fcb -- )      Read the next record and report any error.
20 BDOS               Read next record.
DOS-ERR?              If read error,
ABORT" Read error"    abort with a message.
;

: WRITE ( fcb -- )    Write the next record and report error if any.
21 BDOS               Write the record.
DOS-ERR?              Any error?
ABORT" Write error"   Report and abort.
;

: MAKE-FILE ( fcb -- ) Create a new directory entry for a new file. Report error if any.
22 BDOS               Create directory.
DOS-ERR?              Error?
ABORT" Can't make
file"
;

```

14.2. The File Control Block

The file control block FCB is a table containing essential information so that the DOS system can manage the file in association with the blocks. The next two commands build FCB blocks which is almost all that is needed to create files and gain access to them using the above commands.

```

: (!FCB) ( addr len fcb -- ) Use the string at addr and the length, len, to set up a file control block. This
is the primitive file name parsing word, which breaks the drive/filename/extension
string into a drive specifier, the file name, and the extension, and inserts them
into the proper fields in the FCB.

DUP B/FCB ERASE       Clear the entire FCB to zeros.
DUP 1+ 11 BLANK       Clear the name/extension fields to ASCII blanks.
>R                   Save the FCB address for later use.
OVER 1+ C@            Get the second character in the string on stack.
ASCII : = IF          If it is a ':', then get the first character and use it as the drive specifier.
OVER C@              Get the first character.
[ ASCII A ] LITERAL   Store ASCII code of A here as a literal.
-                   Subtract 65 (ASCII A) from the drive specifier. The result is the drive number.
R@ C!                Store it in the drive number field in FCB.
2 /STRING            Adjust the string address and length to point to the file name.
THEN
R> 1+                Address of the name file in FCB.
-ROT                 Get the string length to top of stack.
0 DO                 Now fill the file name field.
DUP C@ ASCII . =     Is the character a period?
IF                  Yes. End of file name and start of extension.
SWAP                 Swap the FCB field pointer to top of stack.
8 I - +              Compute the address of the extension field in FCB.
ELSE                 Not a period. Stuff the character in the name or extension field.
2DUP C@              Get the character from string.
SWAP C!              Store it in the FCB.
SWAP 1+              Increment the FCB pointer.
THEN
SWAP 1+              Increment the string pointer also.
LOOP
2DROP                Clean the stack to exit.
;

: !FCB ( FCB-addr -- ) Use the following string as the file name string and create an FCB for it. If
CAPS is false, allow lower case file names.
BL WORD              Parse out the next string and place it in the word buffer.
COUNT              Get the string length from the word buffer address left by WORD.
CAPS @ IF           If CAPS is true,
2DUP UPPER          convert the string to upper case.
THEN                Otherwise, allow lower case string.
ROT                 Get the FCB address to top of stack for (!FCB).
(!FCB)             Now, get (!FCB) to fill the FCB with the name string in the word buffer.
;

: SELECT ( drive -- ) Make the given drive the default drive.

```

14 BDOS DROP ;

14.3. High Level File Commands

The following commands are defined in the basic F83 system as shown in KERNEL86.BLK file, screen 57. However, their functions make them a natural part of this chapter on the MS-DOS files. One of the problems in reading Forth source code is that the order in loading the Forth source codes does not necessarily bear any relationship with the logical order of commands. In this book, I hope that grouping commands together according to their functionalities will help you to perceive more clearly the logical structures in the F83 system.

```
: FILE-SIZE ( fcb -- n ) Return the size of the current file in number of records.
  35 BDOS DROP           BDOS function 35 returns the file size in the field of random record number.
  RECORD# @             Get the file size.
;

: DOS-ERR? ( -- f )     Return a true flag if the previous DOS operation is in error.
  255 =                 BDOS returns 255 if an error occurred
.                       ;

: OPEN-FILE ( -- )      Open the current file and store the size of this file in MAXREC#.
  IN-FILE @ 15 BDOS     Open the in-file.
  DOS-ERR? IF          Is there an error?
    ." Open error"
    DISK-ABORT
  THEN                 If so, abort.
  DUP FILE-SIZE        Otherwise, size the file.
  1- SWAP              Number of the last record in file.
  MAXREC# !            Save it.
;

92 CONSTANT DOS-FCB    The zero page address where DOS puts a parsed FCB.

: DEFAULT ( -- )        Open the default DOS file. Move the parsed FCB block to FCBl and open the file.
                          If no file is in DOS-FCB, do nothing.
  FCBl DUP IN-FILE !    Make the default file as specified by FCBl both the in-file
  DUP FILE !            and the current file.
  CLR-FCB               Erase FCBl.
  DOS-FCB 1+ C@         Get the first character in the name field of the DOS file in DOS-FCB.
  BL <> IF              If the first character of file name is not blank, there is a DOS file.
    DOS-FCB FCBl 12 CMOVE Copy the drive number, file name, and extension into FCBl.
    OPEN-FILE           Open the current file.
  THEN ;

: CREATE-FILE ( n -- ) Create a new file and allocate n blocks to this file.
  FCBl2 DUP !FILES     Set the file pointers in both the current file and in-file to point to FCBl2.
  DUP !FCB              Build a FCB at FCBl2 and make it the current file. The file name is taken from
                          the input stream.
  MAKE-FILE             Call BDOS to make the file.
  MORE                  Allocate the require blocks.
;

: MORE ( n -- )        Add n blocks to the current file.
  1 ?ENOUGH             I need at least one stack item.
  CAPACITY SWAP         Current maximum size in blocks.
  SWAP DUP 8*           Record number to be added.
  FILE @ MAXREC# +!     Add to the maximum record field in the current FCB.
  BOUNDS ?DO           Now initialize the whole file to blanks.
    I BUFFER           Get a disk buffer.
    B/BUF BLANK        Clear the disk buffer to blanks.
    UPDATE             Mark the buffer as modified. Next time BUFFER is called to use this buffer, the
                          blanks will be written to the file.
  LOOP
  SAVE-BUFFERS          Flush the remaining buffers out to disk.
  FILE @ CLOSE         Close the file.
;
```

14.4. Save Core Image to a File

A very special usage of the file commands is to save the entire core image in a file which can be called for execution from DOS. This will save lots of compiling time to load in many blocks of utilities. It is also a good way to build an application program without giving the user all the Forth source code, a good way to protect your software product.

```
DEFER HEADER          Create a vectored word.
' NOOP IS HEADER      HEADER is used in the DOS system.

: SAVE ( addr len -- ) Use the name following as the file name and create an executable DOS file. Memory
                        from addr to addr+len is saved into this file. The current file is not disturbed.
FCB2 DUP !FCB         Build a new FCB at FCB2, using the name following SAVE.
DUP DELETE DROP       If this file already exists, delete it.
DUP MAKE-FILE         Create a new file.
HEADER                Build an executable header.
-ROT BOUNDS DO        Scan the given range of memory.
  I SET-DMA            Specify memory address for DMA transfer.
  DUP WRITE            Write one record of 128 bytes.
  128 +LOOP            Increment the index of length for next record.
CLOSE                  Close the file.
;

: SAVE-SYSTEM ( -- )  The high level command to save the code image to a file. You do not have to remember
                        the dictionary addresses.
256                    Starting memory address of the Forth dictionary.
HERE                   End of dictionary.
SAVE                   Make the executable file.
;
```

14.5. Directory Accessing

F83 can access the DOS directory on a disk directly without having to leave the Forth environment. They are convenience that makes you feel at home and eliminate the necessity of learning the DOS system and fight against it.

```
: .NAME ( n -- )      Print the name of the nth entry in the DOS directory.
#OUT @                Get the current output character count in #OUT.
C/L >                 If it exceeds the line length,
IF CR THEN            send a CR to start a new line.
32 * PAD + 1+         The address of the nth entry, already copied to the PAD buffer.
8 2DUP TYPE SPACE     Print the file name.
+ 3 TYPE 3 SPACES     Print the extension.
;

: DIR ( -- )          Print the DOS directory.
[ DOS ]                Switch context to CP/M vocabulary.
" ???????.???"        Put a file name template in PAD.
FCB2 (!FCB)           Create a new FCB with the ? marks in its name and extension fields.
CR PAD SET-DMA         Fetch the directory information to PAD.
SEARCHO                Search for the first directory entry that matches the ? mark name. Any valid
                        file name would do. The stack item returned is the entry number of the file in
                        PAD, just right for NAME.
BEGIN                  Scan the entire directory.
  .NAME                Print the file name and extension.
  SEARCH               Search the next matching file name, i.e., the next file name
  DUP DOS-ERR?         End of the directory?
UNTIL                  If any error flag is returned, we have reached the end of the directory. Exit
                        now. Otherwise, loop back to print the next file name.
DROP                  Drop off the invalid entry number.
;
```

```

: .FILE ( addr -- )      Given the address of an FCB, print the name of this file.
COUNT ?DUP IF          If the drive number is not zero,
  ASCII @ + EMIT ." : "
THEN                    then print the drive prompt.
8 2DUP                  Name field width.
-TRAILING TYPE          Print the file name without the trailing blanks.
+                        The address of the extension field.
." ."                  Print a period sign between name and extension.
3 TYPE SPACE           Print the extension.
;

: FILE? ( -- )          Print the name of the current file.
FILE @                  Get the FCB of current file.
.FILE                  Print its name.
;

```

F83 allows you to have two files opened at the same time: a current file and an in-file. The in-file is used for input and the current file is used for output. The command SWITCH can be used to switch these two files so you can input from the previous current file and output to the previous in-file.

```

: SWITCH ( -- )          Exchange the current file and the in-file.
FILE @ IN-FILE @        Two fcb's.
FILE ! IN-FILE !        Exchange the fcb addresses.
;

: !FILES ( fcb -- )      Set both the current file and the in-file to the given fcb.
DUP FILE ! Set current file.
IN-FILE !               Set in-file.
;

```

14.6. System Level File Commands

The utility commands defined above allow the F83 system to manage DOS files and the associated facility. As a user, you will probably have no need for them unless you have to dig down into the system level. To use the file management system, you need only a few commands at the top Forth level to create files and to gain access to their contents. This section describes these commands and their functions.

```

: FILE: ( -- fcb )      Use the following string as the file name and create a new file. The address of
                        the FCB is returned on the stack.
>IN @                   Save the input character pointer because we will use the next name more than once.
CREATE                  Create a Forth word using the following name. When this word is referenced, the
                        file of the same name in DOS will be opened and made the current file.
>IN !                   Restore the input character pointer to the front of the file name.
HERE DUP                The parameter field address of the file definition.
B/FCB ALLOT             Put the FCB in the parameter field.
!FCB                    Now stuff the FCB with the new file name.
DOES>                  Now comes the execution part of the file definition.
!FILES                  Initialize both the current and the in-file.
;

: ?DEFINE ( -- fcb )    Define the next word as a file if it is not already define. Leave its FCB address
                        on stack.
>IN @                   Save the input character pointer.
DEFINED                 Search the dictionary for the next word, which is supposedly a file name.
IF NIP >BODY            If the file definition is in the dictionary, discard the character pointer because
                        we will not need it. The cfa returned by DEFINED is then changed to pfa which
                        is the FCB of the defined file.
ELSE                    No. The file was not defined.
DROP                    Throw away the word buffer address.
;

```

```

>IN !           Restore the character pointer to the front of the file name.
FILE:          Define a new file with a new file definition in the dictionary.
THEN           ;

FORTH DEFINITIONS
All the file management words were put into the DOS vocabulary, which are not
accessible from Forth. The two most used words concerning files are to be defined
in the FORTH vocabulary so that they can be accessed conveniently.

: OPEN ( -- )   Open the following file and make it the current file.
[ DOS ]        OPEN has to refer to words in the DOS vocabulary.
?DEFINED       Find the file in dictionary. If failed, create a new file.
!FILES         Make this file the current file.
OPEN-FILE      Open it.
;

: DEFINE ( -- ) Define the following word as a new file without opening it.
?DEFINE DROP ;

: FROM ( -- )   Make the next word in the input stream the FROM file. It will be created if not
already being defined.
?DEFINE        Open a file.
IN-FILE !      Make it the in-file.
OPEN-FILE      And then open it.
;

DEFER LOAD     Interpret a screen.

```

In the previous Forth systems, including F83 Version 1, LOAD always interprets a screen from the current file. To allow more natural and more convenient access to multiple files, F83 Version 2 modified the LOAD command so it will load a screen from the in-file, which is set up as the input file. Most of the other file commands access the current file as default. To make sure that other file commands can still access the current file, LOAD only loads one screen from the in-file and then restores the current file.

```

: (LOAD) ( n -- ) Interpret one screen from the in-file.
FILE @ >R        Save the current file fcb.
BLK @ >R         Save the currently processed screen number on the data stack.
>IN @ >R        Save the word parsing pointer also.
>IN OFF         Start at the beginning of the screen.
BLK !           Store n into BLK to process screen n.
IN-FILE @ FILE ! Make the in-file the current file for interpreting.
RUN             Interpret the screen.
R> >IN !        Restore the parsing pointer.
R> BLK !        Restore the previous screen number.
R> !FILES       After loading from the FROM file, restore the current file.
;

' (LOAD) IS LOAD Vector LOAD to execute (LOAD).

1 CONSTANT INITIAL
In all the F83 source files, screen 1 is always a load screen which loads in the
code in the file. INITIAL is defined to load this screen.

: OK           ( -- ) Load applications in the current file.
INITIAL LOAD ;

: A:           ( -- ) Select drive A as the default drive.
0 SELECT ;

: B: ( -- )    Select drive B as the default drive.
1 SELECT ;

```

Chapter 15. Text Editor

The source code of the editors are in the file UTILITY.BLK, Screens 12 to 27.

An editor is the most often used utility in an operating system to support programming activity. The friendliness of an operating system depends heavily on the editor it provides to you. Since the source code in Forth is organized around blocks of 1024 bytes and the editor has to deal only with blocks of fixed size, the editor is simpler than the editors in other systems, which have to be able to handle large text files, usually of variable length.

The line editor in F83 system is compatible with the editor described in the popular book "Starting Forth". For details on the various commands in this editor, see the book by Leo Brodie. There are a few extensions, most notably the command NEW which allows you to enter multiple lines of text.

A screen editor is also provided in F83 so that you always have a full text screen showing on his terminal. The screen editor will be discussed in Chapter 16.

15.1. String Utility

The string manipulation primitives include string comparison and searching. The string search command is used in the line editor to find the desired string. The only unusual feature about this string package is the presence of a variable called CAPS, which determines whether or not to ignore the case of the source and target strings. If case is ignored then A-Z=a-z. The default is to ignore case.

Many string primitives are defined in the kernel, like string compare, lower-to-upper case conversion, etc. Many of them are defined in machine instructions to increase execution speed. Here their high level commands are shown for completeness and for reference. You should consult the sections in the kernel for the code commands actually used in the editor, in the file KERNEL86.BLK, Screens 41-43.

```
VARIABLE CAPS          If true, lower case characters are to be converted to upper case.

: UPC ( char -- char' )  Convert a character to upper case.
  DUP                   Copy char for comparison.
  ASCII a ASCII z       Is it between a and z?
  BETWEEN
  IF BL - THEN          If so, convert to upper case by subtracting 32.
;

: ?CHAR ( char --      Convert a character to upper case if CAPS flag is set.
  char' )
```

```

CAPS @           Is CAPS true?
IF UPC THEN     If so, convert; otherwise skip.
;

: COMPARE        ( addr1 addr2 count -- n ) Compare two strings at addr1 and addr2 of equal length.
                Case may be significant depending on CAPS. 0 is returned if the strings are equal.
                1 is returned if string at addr1 is greater than that at addr2. -1 is returned
                if the string at addr1 is less than that at addr2.

>R             Save the count.
0             The initial value of n to be returned.
-ROT          Put it under addr1.
R>           Retrieve the count.
0 ?DO        Scan through the strings.
  OVER I C@   Get a character from string 1.
  ?UPCHAR    Convert it to upper case if needed.
  OVER I C@   Get the corresponding character from string 2.
  ?UPCHAR    Convert.
  - DUP      Are the characters the same?
  IF        No. The characters are not equal.
  >R       Save the comparison result.
  ROT DROP  Discard the initial n.
  R>       Retrieve comparison result.
  0 < IF -1 If it is less than zero, return -1 because string 2 is larger.
  ELSE 1 THEN
             If the comparison is positive, return 1 to indicate that string 1 is greater than
             string 2.
  -ROT      Put the result below addr1, replacing the initial n.
  LEAVE    Quit the do-loop immediately.
  ELSE DROP
  THEN
  LOOP
  2DROP    Discard the addresses.
;

: INSERT        ( sa sl ba bl -- ) Insert a string at sa into the buffer at ba. The length of
                string inserted is the smaller of sl and bl.
                Save the smaller of sl and bl on the return stack.
ROT OVER MIN >R
R@ -          bl-sl or 0 if sl>bl.
OVER DUP     Buffer address ba.
R@ +        Address of the remainder of the buffer.
ROT CMOVE>   Shift the string in the buffer forward, making room for the string to be inserted.
R>          Restore the count of insert string.
CMOVE       Copy string to buffer.
;

: REPLACE      ( sa sl ba bl -- ) Copy a string from sa to ba. Characters copied is the smaller
                of sl and bl.
                Smaller of sl and bl.
ROT MIN
CMOVE       Copy from sl to ba.
;

: DELETE ( ba bl sl -- ) Delete sl characters from the start of buffer, ba. Fill the end of buffer with
                blanks.
                Save the smaller of bl and sl.
                The remainder of the buffer.
OVER MIN >R
R@ -
DUP 0>      Any character to be move forward in the buffer?
IF          Yes. Copy the remainder of buffer forward to the start of buffer.
  2DUP      Duplicate ba and remainder of buffer.
  SWAP DUP  Buffer address ba.
  R@ +     Address of remainder of buffer.
  -ROT SWAP CMOVE
            Copy the remainder of buffer to the beginning of the buffer.
THEN
+           Address of remainder of buffer.
R> BLANK   Fill the remainder of buffer with blanks.
;

VARIABLE FOUND A local variable to be used by SEARCH as a flag.

: SEARCH      ( sa sl ba bl -- n f ) Search for the string at sa inside the string at ba. If
                found, return the offset of the found string as n and a true flag. If not found,
                f is false and n is meaningless.
                Initialize FOUND to be false.
                Save buffer address ba.
                bl-sl.
FOUND OFF
OVER >R
ROT TUCK -
1+ 0 ?DO
  3DUP COMPARE
            Is the string found at this position?
  0= IF
            If found,

```

```

FOUND ON          Turn on the FOUND flag,
LEAVE            and quit the do loop immediately.
THEN
SWAP 1+ SWAP     Increment the buffer address ba to do the next comparison.
LOOP
DROP NIP        Discard s1 and sa.
R> -           Offset from the beginning of the buffer to the starting point of the found string.
FOUND @         Get the found flag.
;

```

These string commands are the basic commands used in implementing the string editing commands which are needed in both the line editor and the screen editor in this F83 system.

15.2. Terminal Dependent Deferred Commands

Several commands which will be used to control screen display in the screen editor are defined here as deferred commands so that commands defined in the line editor can be used also in the screen editor by re-vectoring these deferred commands.

```

DEFER AT ( col row -- ) Position the cursor at the given location specified by the stack numbers.
DOES>                A vectored word.
-ROT 2DUP #LINE !    Store col in #LINE.
#OUT !              Store row in #OUT.
ROT PERFORM         Execute the word vectored to by AT.
;
AT                  Execute AT vectors to itself.

DEFER BLOT ( col -- ) Delete the rest of the current line.

DEFER -LINE ( -- )   Delete the current line and scroll the rest of screen up by one line.

: DARK ( -- )       Clear the screen and home the cursor.
DOES>              Dark is a deferred word and can be re-vectored.
PERFORM            First execute the routine whose execution address was put into the parameter field.
#LINE OFF         Reset line count.
#OUT OFF          Reset character count.
;
DARK               Vector DARK to itself.

VOCABULARY EDITOR   Create a new EDITOR vocabulary.
EDITOR ALSO         Make it the current vocabulary so that following definitions will be included
DEFINITIONS         in it.

DEFER .SCREEN ( -- ) Display the entire screen.

: (AT) ( col row -- ) Do a carriage return in line editor mode.
2DROP CR          ;

: (BLOT) ( col -- ) Fill the rest of line with spaces.
C/L SWAP -        Characters in the rest of this line.
SPACES            Output spaces.
;

: (DARK) ( -- )     Clear the screen with line feeds.
24 0 DO CR LOOP   Send 24 carriage returns.
;

' (AT) IS AT        Initialize AT,
' (BLOT) IS BLOT    and the rest of the deferred words to support the dumbest possible terminal.
' (DARK) IS DARK
' NOOP IS -LINE
' CR IS .SCREEN

```

15.3. The Cursor Commands

The cursor in the line editor is a pointer pointing to the character position where the next editing actions will occur. The cursor position is stored in a variable R#, as the offset from the beginning of the screen buffer to the address of the current character. All cursor commands use or modify this variable. Often the cursor is represented by a caret '^' on CRT display.

```
VARIABLE R#                Defined in the nucleus.

: TOP ( -- )              Go to the top of the screen.
R# OFF                    Initialize R# to zero.
;

: C ( n -- )              Move the cursor by n characters, right or left.
R# @                      Current cursor position.
C/SCR 1-                  1023, a 10 bit mask.
AND                       Ensure the cursor is within the screen.
R# !                      Replace it.
;

: T ( n -- )              Go to the beginning of line n.
TOP                       Reset R#.
C/L *                     Beginning of the nth line.
C                          Set the cursor. Always within screen.
;

: CURSOR ( -- n )         Return the current cursor position.
R# @                      ;

: LINE# ( -- n )          Return the current line number.
CURSOR C/L /              Divide the cursor position by characters per line.
;

: COL# ( -- n )           Return the current column number.
CURSOR C/L MOD            The modulo of cursor position.
;

: +T ( n -- )             Increment the current line by n.
LINE# +                   Get the new line number.
T                          Select it as the current line.
;

: 'START ( -- addr )      The buffer address of the start of the screen.
SCR @                     The current screen number.
BLOCK                     The address of the buffer.
;

: 'CURSOR ( -- addr )     The actual address of the current character in the buffer pointed to by the cursor.
'START                    Beginning of the screen.
CURSOR +                  Add cursor offset to get the address in the buffer.
;

: 'LINE ( -- n )          The address of the beginning of the current line. 'CURSOR Address of the cursor.
COL# -                    Subtract the column number to get back to the beginning.
;

: #AFTER ( -- n )         return the number of characters after the cursor on the current line.
C/L                       Characters per line.
COL# -                    Characters after cursor.
;

: #REMAINING ( -- n )     Return the number of characters after the cursor on screen B/BUF Characters per
CURSOR -                  screen.
                           Characters after cursor on screen.
;

: #END ( -- n )           Number of characters between the beginning of current line to the end of screen.
#REMAINING                Characters from cursor to end of screen.
COL#                       Characters from start of line to cursor on current line.
+ ;
```

15.4. Editing Buffers

PAD returns the address of a text buffer used by Forth system for string output and temporary storage. The Starting Forth editor requires two additional text buffers: an insert buffer and a find buffer. The insert buffer stores a text string which will be inserted into the screen during editing, and the find buffer stores a string to be used in string search. These two buffers are assigned immediately above the PAD buffer and they all float some distance above the top of the dictionary. Since they are using the free memory space between the data stack and the dictionary, they do not require fixed allocation in the RAM memory.

Some of other editing utility commands are also defined here.

```
VARIABLE CHANGED      A variable indicating that the current screen has been edited so that date stamp
                      can be applied automatically.

: MODIFIED ( -- )     Mark the screen as updated and also set the CHANGED flag.
  CHANGED ON          Set CHANGED flag.
  UPDATE              Set the UPDATE flag.
;

ASCII ^ CONSTANT EOS  EOS is the character to denote the end of a string on input. It allows multiple
                      editing commands on one line.

: ?TEXT              ( addr -- addr+1 n )
                      Accept a string to addr. For a null string, do not disturb the string already
                      at addr.
>R                  Save addr on return stack.
EOS PARSE           Scan the input stream for ^ or end of line.
DUP                 Get the character count of the input string.
IF                 If character count is not 0, do the string copying.
  R@                Retrieve addr.
  C/L 1+ BLANK      Clear one line at addr.
  HERE COUNT        The string is in the word buffer.
  R@ PLACE          Copy the string to addr.
ELSE 2DROP          Clean the stack after PARSE.
THEN
R>                 Get the addr back.
COUNT             Replace it by addr+1 and count.
;

10 CONSTANT ID-LEN   Length of the id stamp buffer.
CREATE ID ID-LEN ALLOT Id stamp buffer containing the user name and date stamp.
ID ID-LEN BLANK      Initialize the id stamp buffer.
84 CONSTANT C/PAD    All text buffers are to be 84 characters long.

: 'INSERT ( -- addr ) Return the address of insert buffer.
  PAD C/PAD +        84 bytes above PAD.
;
```

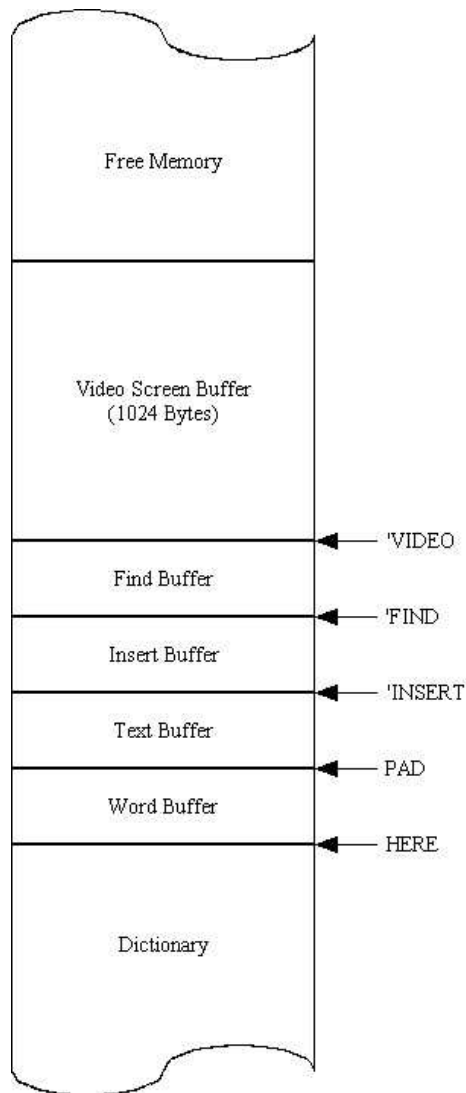

Figure 15.1 The editing buffers.

```

: 'FIND ( -- addr )      Return the address of find buffer.
'INSERT C/PAD +        84 bytes above the insert buffer.
;

: 'VIDEO ( -- addr )    Return the screen editor buffer.
'FIND C/PAD +          4 bytes above the find buffer.
;

: .FRAMED ( addr -- )  Print a string at addr framed with single quotes.
." '"                 Print preceding quote.
COUNT TYPE           Print the string.
." '"                 Print following quote.
;

: .BUFS ( -- )         Display the contents of the insert and find buffers.
CR ." I "             Header for insert string.
'INSERT .FRAMED       Print insert buffer.
CR ." F "             Header of find string.
'FIND .FRAMED         Print find buffer.
;

: ?MISSING             ( n f -- n, or abort ) If flag is false, print the find buffer and abort. Otherwise,
return only n.
0= IF                 If flag is false, do the following.
DROP                  Discard n.

```

```

'FIND .FRAMED          Print contents of find buffer.
." not found "        This is used when a string cannot be found in the screen.
QUIT                  Give up and return to the text interpreter.
THEN                  ;

: KEEP ( -- )         Copy the current line into the insert buffer.
'LINE                 Address of current line.
C/L 'INSERT PLACE     Copy the line to insert buffer.
;

: K ( -- )           Exchange the contents of the insert and find buffers.
'FIND PAD C/PAD CMOVE Copy find buffer into PAD buffer.
'INSERT 'FIND C/PAD   Copy insert buffer to find buffer.
CMOVE
PAD 'INSERT C/PAD     Copy old find string to insert buffer.
CMOVE
;

: 'F+ ( n1 -- n2 )   Add the length of the found string to n1.
'FIND                 Address of the find buffer.
C@                    Length of find string.
+                      ;

: W ( -- )           Abbreviation of SAVE-BUFFERS.
SAVE-BUFFERS         ;

: 'C#A ( -- addr count ) Return the address of the cursor and the characters after cursor on the current
line.
'CORSOR               Address of the cursor.
#AFTER                Characters after cursor.
MODIFIED              Update flags.
;

: (I)                ( -- len 'insert len 'cursor #after)
Get input string into the insert buffer and leave addresses and lengths necessary
to do the insertion.
'INSERT ?TEXT         Get input text and copy it into the insert buffer.
TUCK                  Tuck a copy of len under address of insert buffer.
'C#A                  Push cursor address and character count on stack.
;

```

15.5. Line Editing Commands

Line editing commands modify the contents of the current line in the current screen. Many of these commands expect a string immediately following the command in the same input line. The string may be a null string, i.e., the command is followed immediately by a carriage return. In this case, the contents of the appropriate buffer are used in place of input string. The text string is shown as <text>, which is a sequence of ASCII characters. Blanks or spaces can be included in the string. The string is terminated either by a carriage return or by the carat character '^'.

```

: I ( -- )           I <text> inserts text string on the current line at the cursor.
(I)                  Get the insert string.
INSERT               Insert it on the current line.
C                    Move the cursor to the end of the inserted string.
;

: O ( -- )           O <text> overwrites text string on the current line at the cursor.
(I)                  Get the insert string.
REPLACE              Write over the current line with the insert string.
C                    Move cursor to end of inserted string.
;

: P ( -- )           P <text> replaces the current line with <text> and blank fill the rest of the
line.
'INSERT ?TEXT         Get insert string.
DROP                  Discard character count.
'LINE C/L CMOVE      Copy the entire line.

```

```

MODIFIED          Update flags.
;

: U ( -- )       U <text> inserts a line under the current line. Subsequent line in the screen
                  are pushed down by one line. The last line is lost.
C/L C            Move the cursor to next line.
'LINE C/L OVER #END
INSERT          Insert a dummy line at the next line and push all subsequent line down.
P              Put the insert string at the next line.
;
: X ( -- )       Delete the current line and save it in the insert buffer.
KEEP           Save the current line in the insert buffer.
'LINE #END C/L DELETE
MODIFIED        Update flags.
;

: SPLIT ( -- )   Break the current line in two at the cursor.
PAD C/L 2DUP BLANK
                Clear the PAD buffer.
'CORSOR #REMAINING
INSERT          Address of cursor and characters to end of screen.
MODIFIED        Insert a line of blanks at the cursor.
;

: JOIN ( -- )    Put a copy of next line after the cursor.
'LINE C/L +     Beginning of the next line.
C/L            Copy one line,
'C#A INSERT     to the cursor.
MODIFIED
;

: WIPE ( -- )    Clear the screen to blanks.
'START B/BUF BLANK
MODIFIED        Fill the screen with blanks.
;

: M ( m n -- )   M copies the current line to nth line in the mth screen. M is neutralized because
                  the editor should not affect other screens and M moves the current line to another
                  screen.
TRUE ABORT" Use G!"
                Always abort.
;

: G ( screen line -- )
                  Get a line from another screen and insert it in front of the current line.
C/L *          character offset to the line.
SWAP IN-BLOCK +
                Get the source block from the in-file. Add offset to the source line.
C/L 'INSERT PLACE
                First put the source line in the insert buffer.
C/L NEGATE C   Move the cursor to the line above.
U              Insert the source line.
C/L C          Move the cursor back.
;

: BRING          ( screen first last -- )
                  Get a range of lines from another screen.
1+ SWAP DO     Scan the range of lines.
  DUP          Source screen number.
  [ FORTH ] I  Select the loop index in FORTH, not the I defined above in EDITOR.
  G            Get one line.
LOOP
DROP           Discard the screen number.
;

```

15.6. String Editor Commands

The main task of the string editor is to locate a string inside the current screen and place the cursor at the end of the found string. This allows you to modify strings in a screen quickly, and to make local modifications as you debugs source code. The string pattern to be searched is put in the find buffer.

```

: FIND? ( -- n f )  Get the find string from the input stream and search for a matching string in
                    the screen starting at the current cursor position. Return the character offset

```

```

of the found string as n and a true flag if the string is found. Return a false
flag if not found, and n is meaningless in this case.
Address of the find buffer.
Get the input text into find buffer.

'FIND
?TEXT
'C#A SEARCH
SEARCH
;

: F ( -- )
FIND?
?MISSING
'F+ C
;

: E ( -- )
'FIND C@
DUP NEGATE C
'C#A ROT DELETE
;

: D ( -- )
F
E
;

: R ( -- )
E
I
;

: S ( n -- )
1 ?ENOUGH
FIND?
IF 'F+ C EXIT THEN
DROP
FALSE
OVER SCR @ DO
N
TOP
'FIND COUNT
'C#A SEARCH
SEARCH
IF
'F+ C
DROP TRUE
LEAVE
ELSE DROP
THEN
KEY? ABORT" Break!"
LOOP
?MISSING
;

: (TILL) ( -- )
'FIND ?TEXT
'C#A SEARCH
?MISSING
;

: TILL ( -- )
'C#A (TILL)
'F+ DELETE
;

: JUST ( -- )
'C&A (TILL)
DELETE
;

: KT ( -- )
'C#A (TILL)

```

```
'F+           The end of string.  
'INSERT PLACE Copy the characters into insert buffer.  
;
```

15.7. Screen Editor

The line editor works on the source screen one line at a time. It serves well all the editing functions. The only problem is that the text screen displayed on the terminal scrolls up with the entering of new lines at the bottom of terminal screen. After some editing, compiling and testing, the text screen starts to disappear over the top of the terminal and you must type L command to re-display the text again. As the terminals getting smarter and smarter, it is nice if we can use some of the extra functions in the terminal to keep the text screen at the top of the terminal all the time. This is basically what a screen editor does. Any time the text screen is modified, the modification will be written on the displayed text screen immediately.

If all the terminals were built the same way, it would be a simple exercise to write a screen editor. However, terminals are built with different screen control commands. The screen editor must be tailored to the specific terminal to use its specific cursor and display control commands. The screen editor in F83 uses all the commands developed in the line editor for editing functions. The terminal-specific functions are concentrated in four commands: AT, DARK, BLOT, and -LINE, which manage a continuous display of the edited text screen. The display is updated automatically as each command line is executed.

Lines	Contents
0	Screen Number and File Name
1	Commet
	ID Stamp
	15 Lines of Screen Text
16	
17	Current Line
18	
	Scrolling Command Window
23	

Figure 15.2 Screen editor display

15.8. The Screen Display Commands

The display on the terminal is assumed to have a 24 by 80 character format. The screen editor displays the screen number on the top line or line 0 on the screen display. Lines 1 to 16 are used to display 16 lines of text in the current screen. Line 17 display the current line. Lines 18 to 23 are used as a scrolling window for command input and character output. The text screen stays at the top of display and always shows the updated text of the current screen under editing.

```

3 CONSTANT DX          Column offset for screen text. Allow room for line numbers.
1 CONSTANT DY          Row offset for screen text. Allow room for screen number.

: .LINE ( -- )         Display the current line, with the cursor shown as an up-arrow or caret.
LINE# 2 .R SPACE      Display the current line number.
'LINE COL# >TYPE      Display the text before cursor.
ASCII ^ EMIT          Display ^, current position of the cursor.
'CORSOR #AFTER >TYPE  Display the text after the cursor.
;

: REDISPLAY ( line# -- ) Update the image of line n on the terminal.
0 OVER DY +          Column and row of line n on the display.
AT                   Move the display cursor to the display coordinates.
DUP 2 .R SPACE       Print the line number.
DUP C/L *            Character offset of line n.
'START +             Address of line n in screen buffer.
C/L TYPE            Display the entire line.
SPACE .             Display the line number.
#OUT @ BLOT         Erase the rest of the line.

```

```

;

: CHANGED?      ( line# -- f )
                Return a true flag if the line has changed since last display.  It is sensitive
                to case changes.
C/L *
DUP 'START +    Character offset to the line.
SWAP 'VIDEO +   Address of the line in the buffer.
C/L COMP        Address of same line in the video buffer.
;               Compare the lines in text screen and video buffer.
                Return true if two line are different.

: .ALL ( -- )   Redisplay all lines which have changed, the screen number, the cursor line, and
                scroll the command region.

DISK-ERROR @ 0= If no disk error, display the screen.
IF
  DX 0 AT .SCR   Display the screen number.
  #OUT @ BLOT    Erase the rest of the line.
  [ FORTH ]     Switch context to FORTH because
  ?STAMP        Stamp the screen if not done.
  L/SCR 0 DO     Scan all the lines in the screen.
    I CHANGED?  Has this line been changed?
    IF I REDISPLAY
      THEN      If changed, redisplay the new line.
    LOOP
  'START 'VIDEO B/BUF Update the video buffer.
  CMOVE
  0 18 AT .LINE  Display the current line under the displayed screen.
  0 19 AT -LINE  Delete line 18 on display and scroll up the rest of screen display.
  0 23 AT        Position the display cursor at the bottom of display, assuming 24 line display.
  #OUT OFF      Clear output character count.
THEN
;

: EDIT-AT ( -- ) Move the display cursor to show the position of the editor cursor for editing
                functions.
CURSOR C/L /MOD Convert cursor offset to screen coordinates.
SWAP DX +       Column number.
SWAP DY +       Row number.
AT              Move the display cursor.
;

: NEW ( n -- )  Move the display cursor to the beginning of line n and accept text for following
                lines until a null line (a line begins with a carriage return) is entered, i.e.,
                2 CR's gets you out of NEW.
L/SCR SWAP DO   Scan from line n down.
[ FORTH ] I     Loop index.
[ EDITOR ] T    Position editor's cursor.
EDIT-AT         Position the display cursor.
>IN OFF         Reset the input character offset.
QUERY           Wait for a line of input text.
SPAN @          Number of characters in the input text.
IF              If not a null line,
  P             Put the text in the current line.
ELSE            For a null line,
  [ FORTH ] I   Get the current line number,
  REDISPLAY     Put back the old line.
  LEAVE         Quit here.
THEN
.SCREEN         Refresh the display.
LOOP
.SCREEN
;

: GET-ID ( -- ) Check the ID stamp field.  If it is empty, prompt for user's id and date.
ID ID-LENGTH    Get the ID string address and length.
-TRAILING NIP 0= Is the length 0?
IF              Yes.  Prompt the user.
  CR ." Enter you ID: "
  ID-LEN 0 DO   Display a string of dots.
  ASCII . EMIT
  LOOP
  ID-LEN BACKSPACES Backspace over the dots.
  ID ID-LEN EXPECT Input the id stamp to the id stamp buffer.
THEN
;

```



```

: STAMP ( -- )      Put the stamp at the end of line 0 in the current screen.
ID                 Id buffer address.
'START C/L +      End of line 0.
ID-LEN 1- -      Backup the length of stamp text.
ID-LEN 1-
CMOVE             Copy the stamp to screen.
;

: ?STAMP ( -- )    Update the ID if the screen has changed and clear the change flag.
CHANGED @ IF     Changed?
STAMP            Stamp the screen.
CHANGED OFF     Reset changed flag.
THEN ;

2VARIABLE AUTO    Addresses of CR and STATUS to patch vectors for CRT and TTY, respectively.
VARIABLE EDITING? Set during editing.
VARIABLE CHANGED Set if the edited screen has been changed.

: INSTALL ( -- )   Initialize the screen editor.
EDITING? @ NOT IF If not in the editing mode, initialize screen editor.
['] .SCREEN       Address of the screen refresher.
AUTO @ !         Vector it through AUTO.
EDITING? ON      Turn on editing flag.
CHANGED OFF     Turn off changed flag.
THEN
DISK-ERROR OFF  Turn off the disk error flag always.
;

```

15.9. The Screen Editor Commands

```

FORTH DEFINITIONS  The following screen editing commands should be made accessible from the common
                   FORTH vocabulary.

: DONE ( -- )      Normal exit from the screen editor. Update the id stamp, tell you if the screen
                   was modified, flush the screen to disk file, and remove automatic screen refresh.

[ EDITOR ]
EDITING? @ IF     If still in the editing mode,
PREVIOUS
EDITING? OFF     turn off editing flag,
CR SCR ?        type the screen number,
>UPDATE @ 0< NOT IF and look at the update field.
." Un" THEN     Not updated. Print prefix.
." modified"    Complete the message.
?STAMP         Update the ID stamp.
W             Save contents to disk file.
THEN
DISK-ERROR OFF  Turn of disk error flag to normal scrolling mode.
AUTO 2@ !
Revector CR
;

: ED ( -- )        Re-enter the screen editor. Clear and initialize the display and begin automatic
                   screen refresh.

[ EDITOR ] GET-ID Get id stamp.
INSTALL         Initialize the screen editor.
EDITOR         Make EDITOR the context vocabulary.
'VIDEO B/BUF ERASE Clear the video buffer.
DARK          Home the cursor and clear CRT.
.ALL         Print the screen on CRT.
;

: EDIT ( n -- )    Set n as the current editing screen and call ED to do screen editing.
1 ?ENOUGH      Abort if the stack has less than one item.
SCR !         Store n in SCR, making screen n the current editing screen.
[ EDITOR ] TOP Move editor cursor to top of screen.
ED           Do screen editing.
;

: (WHERE) ( pos scr -- ) When an error occurred during compilation, the position and screen number where
                           error occurred are saved on the data stack. (WHERE) uses these two numbers to
                           invoke the screen editor and show the screen to be edited.

DISK-ERROR @ 0= Make sure the error is not caused by disk reading.
IF

```

```

EDIT                Do screen editing.
[ EDITOR ] 1- C     Position the display cursor before the error.
'WORD COUNT 'FIND  Put the word in trouble into the find buffer.
PLACE
THEN ;

```

15.10. Configuring The Terminal

Each terminal manufacturer has its own way of controlling the display on the terminal screen. To use the full power of a screen editor, the screen editor must know how to position the display cursor at any position on the display screen and a few other things like initialize the display, erase one line and delete one line. In F83 system, terminal configuration commands are provided for a number of popular terminals. If your terminal is not in this list, you will have to define the proper commands. You can follow the pattern as provided. It is not a very difficult task.

An example is shown here. You should consult the F83 listing for other terminals.

```

: SMART ( -- )      Initialize vectored routines for the IBM PC.
['] CRLF           Execution address of carriage return.
['] CR >BODY       Vector address in the deferred word CR.
AUTO 2!           Store them in the AUTO area.
['] .ALL IS .SCREEN Vector .SCREEN to .ALL.
;

CODE IBM-AT ( col row  Position cursor at the specified location on CRT screen.
-- )
AX POP DX POP AL DH MOV  Copy col and row into DX.
BH BH XOR              Clear BH register.
2 # AH MOV             Cursor positioning code.
16 INT                Call BIOS.
NEXT
END-CODE

CODE IBM-DARK ( -- )  Clear screen and home the cursor.
2 # AX MOV            Home code.
16 INT                Call BIOS.
NEXT
END-CODE

CODE IBM-BLOT ( col -- ) Clear from cursor to end of line.
80 SWAP -             Remaining characters on the line.
SPACES                Output that many spaces.
;

CODE IBM-LINE ( -- )  Delete the current line and scroll the rest of the screen.
BP PUSH              Save BP register.
BH BH XOR            Clear BH.
3 # AH MOV 16 INT    Call BIOS for cursor position.
DH CH MOV            Line number moved to CH.
CL CL XOR            Column number cleared to zero.
24 256 * 79 +        Bottom line and right-most column
# DX MOV              copied to DX register.
7 # BH MOV
6 256 * 1 + # AX MOV Code stored in AX.
16 INT                Call BIOS.
BP POP                Restore BP.
NEXT
END-CODE

: IBM ( -- )          Initialize the screen editor for IBM PC.
SMART                 Vector CR and .SCREEN.
['] IBM-AT IS AT      Vector the rest of terminal specific commands.
['] IBM-DARK IS DARK
['] IBM--LINE IS -LINE
['] IBM-BLOT IS BLOT

```

Chapter 16. Viewing Source Screens

The source code about viewing is scattered in UTILITY.BLK, screen 7, EXTEND86.BLK screen 12, and KERNEL.BLK Screens 66 and 76.

Forth with its hosts of commands can be looked upon from two opposing points of view. For the Forth advocates, it is called modularity because commands can be individually executed or compiled to build higher level commands. For others it is called fragmentation, because functions are scattered in hundreds of small bits and pieces. To decipher a colon command, you have to know the exact functions of every command in this command. It is not an easy job to find them because they seldom are grouped in one place.

F83 has more than 1000 commands in it. How can you find any particular command in this mess?

The designers of F83 provide us with a viewing facility which allows us to locate the source code of all the commands in the dictionary and display the block of texts that contains the source of the command we look for. To accommodate this facility, the format of Forth commands in the dictionary is changed from the traditional form of name field, link field, code field and parameter field to that as shown in Fig. 16.1.

16.1. The View Field

The view field is used to store information about where the source code of the command is located. It is two bytes long and divided into two sub fields: the lower 12 bits contain the block number of the source code and the upper four bits contain the file number of a DOS file containing the block. Let's first examine some of the low level commands associated with the view field:

```
: VIEW# ( -- addr )      Return the view field in the current FCB.
FILE @                  Address of the current FCB.
40 +                    Offset by 40 bytes to the view field.
;

: ,VIEW ( -- )          Compile the view field in a new definition.
VIEW# @                 Get the view file number of the current file.
4096 *                  Shift it to the upper 4 bit file number subfield.
BLK @ +                 Add the block number of the screen under compilation.
;

: "CREATE ( -- )        Create the header of a new definition. This definition was discussed in the
                        chapter on the vocabulary structure.

: >VIEW ( cfa -- vfa )  Go from code field to the view field.
>LINK                   Go to link field first.
2-                       View field is two bytes ahead of the link field.
;
```

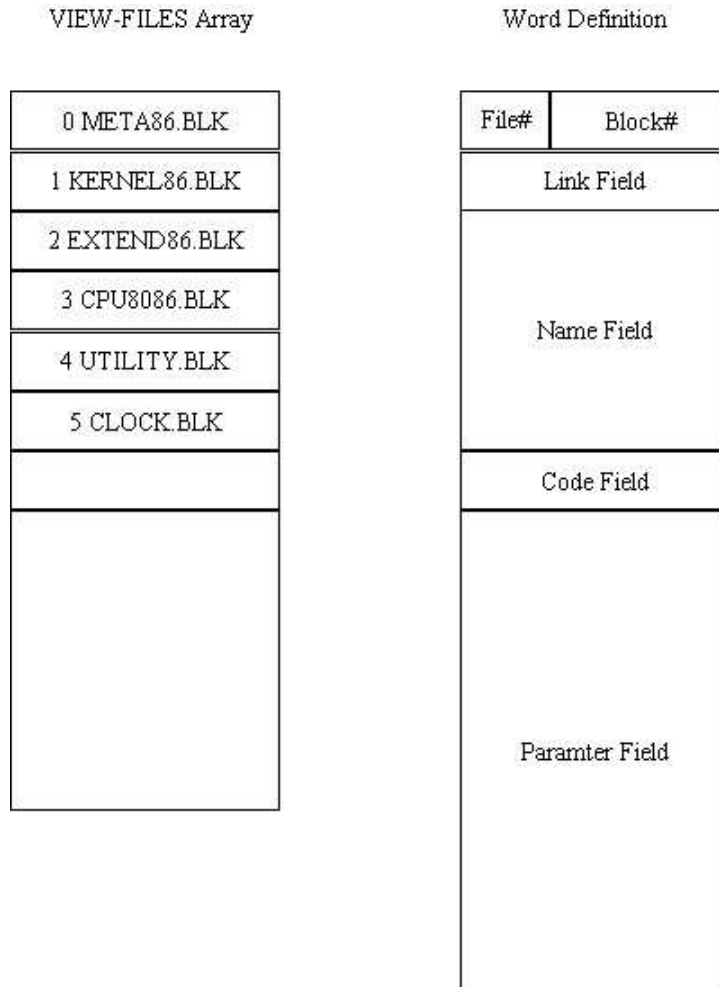

Figure 16.1 The view field and the view files.

```
: VIEW> ( vfa -- cfa ) Go from view field to code field.
2+ To link field.
LINK> From link field to code field.
;
```

16.2. The View Files

The view field in a command has a view file number in the view field. From this number the viewing command will have to find the file and open it for viewing. The view file number for different source files are assigned and pertinent information are stored in an array called VIEW-FILES. In the file control block (FCB) in the definition of each source file, bytes 40 and 41 are used to store the view file number. This provides the file number to store into the view field when the command was first compiled into the dictionary.

```
CREATE VIEW-FILES An array where the view files are arranged in sequential order so that the viewing
32 ALLOT command can find and open the source file of a word definition.
There is enough space to define 16 files for viewing.

: VIEWS ( n -- ) Assign the view file number on the stack to a file and store the fcb address in
```

	the corresponding entry in the VIEW-FILES array.
[DOS]	
?DEFINE	Search the dictionary for the word name following VIEWS. It must be a file name and the fcb address is returned.
2DUP 40 + !	Store number n into the view# field in the FCB of the file
BODY>	Get the execution address of the file definition.
SWAP 2*	The address offset into the VIEW-FILES array.
VIEW-FILES + !	Store the fcb address into the VIEW-FILES array.
;	

Now, view files can be assigned view file numbers to fill the VIEW-FILES array:

```
1 VIEWS KERNEL86.BLK
2 VIEWS EXTEND86.BLK
3 VIEWS CPU8086.BLK
4 VIEWS UTILITY.BLK
```

These are the source files in the F83 system. All the commands loaded from these files can be viewed. If you have some application programs in another file, you will have to assign a view file number to it using the VIEWS command as above. After that, you can load in your application and can view the commands loaded in from your file.

16.3. The Viewing Command

Assuming that all the source code files are on the default disk drive, it is very easy to display a screen which contains the command you want to examine. The command is as following:

```
VIEW <name>
```

where <name> is the name of the command you want to review. The command VIEW will locate the word <name> in the dictionary and find out the file and the screen number of the source code of this command. It will then open that file and read the screen from the file and display the screen on the CRT terminal.

: @VIEW	(cfa -- scr# file#) From the code field address of a definition, find its view field and return the screen number and the file number stored in the view field.
>VIEW	Get the view field address.
@ DUP 4095 AND	Mast off the top 4 bits in the view field and leave only the screen number.
DUP 0=	If the screen number is 0,
ABORT" entered at	abort because the word is not loaded from a file.
terminal"	
SWAP 4096 / 15 AND	Extract the view file number from the top 4 bits.
;	
: VIEW (--)	Allow the user to see the source screen of the following word. If the VIEW# is zero, then the current file is used. Otherwise, the associated field is opened and viewed.
'	Find the cfa of the following word.
@VIEW	Get the screen number and the view file number.
?DUP IF	If the file field is zero, use the current file. If not zero,
2* VIEW-FILES + @	find the cfa of the view file in array VIEW-FILES.
." is in "	Print the file name first.
2DUP >BODY .FILE	
." screen " .	And also the screen number.
EXECUTE	Make the file our current file.
OPEN-FILE	Open it for reading.
ELSE	The definition is in the current file.
." may be in the	
current file: "	
FILE?	Print the file name,
." screen " DUP >	and the screen number.

```
THEN
LIST          Show the screen.
;
```

View file number 0 is reserved for the current file if it has not been assigned a view file number. Up to 15 files can be stored in the VIEW-FILES array for viewing. If you have to use the second drive to store some of the files, the drive number in their FCB must be assigned accordingly.

Chapter 17. WORDS

The source code in this chapter is in file UTILITY.BLK, Screens 3 and 5.

The command WORDS (VLIST in older Forth systems) displays all the commands defined in a vocabulary. It is very useful in inspecting the dictionary contents, and also in determining the progress of compilation when a large application is being loaded. The implementation of this command in F83 system is slightly more complicated because the vocabulary is hashed into four threads.

17.1. Output Formatting Commands

To display a sequence of variable length names on the CRT terminal or printed on a printer, it is necessary to wrap a whole word around the end of a line instead of breaking a word. A few commands allow us to detect the end of line condition and insert a carriage return before printing the last word.

```
VARIABLE LMARGIN      The column number of the left margin.
0 LMARGIN !
VARIABLE RMARGIN      The column number of the right margin.
70 RMARGIN !

: ?LINE ( n -- )      If the current line does not have space for n more characters, move to the next
                      line.
#OUT @                Current character count.
+ RMARGIN @ > IF      Add n to it. If it is greater than the right margin,
CR                    Move to the next line.
LMARGIN SPACES        Align to the left margin.
THEN                  ;

: ?CR ( -- )          Move to next line if we had passed the left margin already.
0 ?LINE
;
```

17.2. WORDS

In the parameter field of the command of a vocabulary command like FORTH, EDITOR, or DOS, etc., there are four addresses pointing to the ends of four thread in the dictionary. They are the link field addresses of the four newest commands defined in the vocabulary. To print out the entire list of names in the vocabulary, we have to trace through these four threads and print out command names in the descending order according to the addresses. These four addresses are first moved to the top of the dictionary. The largest address is first used to print the name which was defined last. This address is replaced by the next address in its thread, and the process is repeated until all names are printed.

```
: LARGEST            ( addr n -- addr' val ) Given an address and a number on the stack, return the
```

OVER 0 SWAP	address and the value of the largest entry in the array.
ROT 0 DO	Add 0 and addr on the stack.
2DUP @ U<	Scan through the array.
IF	Compare contents of an array entry with the current largest value.
-ROT 2DROP	If the entry is greater,
DUP @ OVER	discard the old address and its value,
THEN	and replace them with the new address and its value.
2+	Next address to be scanned.
LOOP	
DROP	Discard the address used for scanning.
;	
: WORDS (--)	List the words in a vocabulary. It can be interrupted by pressing any key.
CR LMARGIN @ SPACES	Align to the left margin.
CONTEXT @	The context vocabulary.
HERE #THREADS 2*	Copy the array of thread ends to the word buffer.
CMOVE	
BEGIN	Begin the printing loop.
HERE #THREADS	Pick the largest address in the thread array.
LARGEST	
DUP WHILE	If it is not zero, print a name. Otherwise, the vocabulary is exhausted.
DUP L>NAME	From the link field, move to the name field.
DUP C@ 31 AND	The length of the name.
?LINE	Make sure there is enough room at the end of a line.
.ID	Print one name.
SPACE SPACE	Add 2 spaces.
@ SWAP !	Replace the largest address in the thread array by the address of the next word in the thread.
KEY? IF EXIT THEN	Exit if a key is pressed.
REPEAT	Continue until all names are printed.
2DROP	Discard the address and a value, which is zero.
;	
ROOT DEFINITIONS	WORDS must also be defined in the ROOT vocabulary.
: WORDS WORDS ;	WORDS can now be accessed any where in the F83 system.
FORTH DEFINITIONS	

Chapter 18. Disk File Utility

The source code in this chapter is in UTILITY.BLK, Screens 4, 7 and 8.

18.1. Displaying Screens In a File

The line editor allows us to examine and modify screens, one at a time. For large application which requires many screens, it is necessary to have some commands which allow us to scan the contents of a file so that we will know which screen to examine in detail. These cammands are also useful in generating hardcopy of source code on a printer.

```
: .SCR ( -- )          Print the current screen number and the file name.
. " Scr # " SCR ?     Print the screen number,
8 SPACES FILE?       and the file name.
;

: LIST ( n -- )       List the specified screen in the 16 by 64 character format. Pressing a key stops
the printing. LIST also makes n the current screen.
1 ?ENOUGH            Make sure n is on the stack.
CR DUP SCR !         Make n the current screen.
.SCR                 Print screen number and file name.
L/SCR 0 DO           Scan 16 lines.
  CR I 3 .R SPACE    Print the line number first.
  DUP BLOCK          Get the screen from the file and return the buffer address.
  I C/L * +          Line address in the buffer.
  -TRAILING >TYPE    Print one line of text.
  KEY? ?LEAVE        Quit if a key is pressed.
LOOP
DROP CR              House keeping.
;
```

To print multiple screens on paper, it is nice to arrange three screens to a page. By convention, the first screen number is a multiple of three so that a group of three screens forms a unit in arranging your source code. TRIAD is the command to print screens in this style.

```
: TRIAD ( n -- )      Print three screens on a page. The nth screen must be printed. The top screen
has a screen number modulo 3.
12 EMIT             Form feed.
3 / 3 *             Modulo 3 boundary.
3 BOUNDS DO         Print only 3 screens.
  I LIST             One screen at a time.
LOOP
;
```

The top line in a screen is usually a comment line. Besides the documenting function, it also allows you to scan a range of screens and identify the contents of screens easily. F83 also puts an ID stamp at the end of the top line. The command INDEX prints the top lines of a range of screens. It is very handy as a substitute of a screen directory.

```
: .LINE0 ( n -- )     Print line 0 of nth screen.
DUP 3 MOD           If n is evenly divisible by 3,
0= IF CR THEN       send out an extra line feed.
CR DUP 3 .R SPACE   Print the screen number.
BLOCK               Get the screen from file.
```

```

C/L -TRAILING >TYPE      Print the top line.
;

: INDEX ( start end -- ) List the top lines in a range of screens.
  2 ?ENOUGH              It needs two parameters.
  1+ SWAP DO             Scan the range of screens.
  I .LINE0               Print top line only.
LOOP
CR                        ;

: IND ( n -- )           Start printing index lines from screen n. Continue until a key is pressed.
BEGIN                   Start with screen n.
  DUP .LINE0            Print one top line.
  1+                    Increment n .
  KEY? UNTIL           Stop when a key is pressed.
DROP                    ;

```

18.2. Disk Buffers

Screens or blocks of 1024 bytes are the basic units for Forth program source code. The size of block is convenient to develop modularized programs because the block of text fits comfortably inside a standard CRT screen, while allow enough room to do loading and testing of the source code. Since the screens can be compiled independently, it is the common practice to use a load screen which loads other screens in the order that is required by the application. Therefore, screens do not have to be arranged in a specific order. However, there are times when we would like to move texts screens around and physically arrange them in some order, especially if the texts are to be printed and communicated to other people. Disk copying utility in F83 enables you to copy single or multiple screens within a file and also from one file to another.

To fully appreciate the disk copying utility in F83, it is necessary to understand fully the disk buffer structure used in the F83 system to handle the traffic from and to the disk files. Let us briefly review the F83 disk buffers.

In the high RAM memory, a number of disk buffers are assigned by the system at boot up time. Each buffer is 1024 bytes in size to hold a block of text or data, corresponding to the data stored in a corresponding block in a disk file. The number of disk buffers is specified in a constant #BUFFERS. Immediately before the first disk buffer, there is an array storing the essential information about the disk buffers. Each disk buffers has a corresponding entry in this array. An entry consists of four cells for the block number, a pointer to the parent file, the address of the disk buffer, and an update flag. Whenever a block is accessed, its array entry is moved to the beginning of the array, indicating it is the most recently accessed buffer. The buffer with an array entry at the end of the array is the least accessed buffer and will be re-assigned to receive other disk block when necessary.

In doing multiple block copying, it is generally desirable to read/write all the disk buffers together and in sequence to minimize the disk head movements and the start/stop of the disk drive. F83

disk copy utility tries to optimize the disk accessing, as it normally uses four disk buffers.

More detailed information on the disk I/O is covered in the chapters dealing with the nucleus and DOS of the F83 system.

18.3. Single Block Copying

To copy one block of text or data to another block in the same disk file, the most efficient way is not physically copying the block, but to bring the source block into one disk buffer and reassign that buffer to the destination block with the update flag set. The data in the buffer will be flushed into the destination block when the buffer is needed for other disk I/O transaction.

```
: ESTABLISH ( n -- )      Set the block number of the most recently referenced block to n, thus assign the
                           buffer to the nth block.
FILE @ SWAP              Get the current file fcb.
1 BUFFER#                Get the address of the first entry in the buffer pointer array.
2!                       Store n into the first cell in that entry, forcing the most recently referenced
                           block to become the nth block. The current file number is store into the second
                           cell.
;

: (COPY) ( from to -- )  The primitive word to copy one block to another.
OFFSET @                 Get the block offset number of the current file.
+                         The actual block number of destination.
SWAP                     Get the source block number to top of stack.
IN-BLOCK                 Get the source block into the most recently referenced buffer.
DROP                     The buffer address is not needed.
ESTABLISH                Claim this buffer for the destination block.
UPDATE                   Update the buffer so that it will be written back to the destination block.
;

: COPY ( from to -- )    To be careful, copy a block and explicitly flush it to disk.
FLUSH                    Empty the disk buffers to disk files. Important when accessing multiple files.
(COPY)                   Do the copying.
FLUSH                    Flush the destination block.
;
```

18.4. Multiple Block Copying

When we copy a range of consecutive blocks from one place to another, complication arises if the destination range overlaps with the source range. To avoid conflicts in the overlapped copying, the direction of copying must be carefully selected.

```
VARIABLE HOPPED          The number of screens to skip when copying.
VARIABLE U/D             The direction of copying to avoid overlap.
DEFER CONVEY-COPY        A deferred word. It will be used to copy within one file and copy between files.
' (COPY) IS CONVEY-COPY  For the moment, define it to copy blocks in the same file.

: HOP ( n -- )           Specify the number of screens to skip in copying.
HOPPED ! ;

: .TO ( n1 n2 -- n1 n2 ) Print a message while copying.
CR OVER .               Print n1.
." to "                 Print n2.
DUP .
;

: (CONVEY) ( blk n --    Move a range of screens in the direction specified by U/D.
```

```

blk+-n )
0 ?DO          Copy n blocks.  If n=0, exit immediately.
KEY? ?LEAVE   Stop if user hit a key.
DUP DUP       Source block number.
HOPPED @ +    Destination block number.
.TO          Print something to indicate that the computer is workin hard.
CONVEY-COPY   Copy one block a time.
U/D @ +      The next source block.
LOOP
FLUSH        Flush the blocks still in the disk buffers.
;

: CONVEY      ( first last -- )
              Move a set of screens.  First determine the direction of copying to prevent
              overlap.  Move the blocks as a set whose size is determined by the number of
              available disk buffers.

FLUSH        Clear the buffers.
HOPPED @     Get the screen number to skip.
0< IF       If copying from high block to low block,
  1+ OVER -  Number of blocks to copy.
  1         Copy in the forward direction.
ELSE        Copying from low block to high block.
  DUP 1+ ROT -  Number of blocks to copy.
  -1         Copy in the backward direction.
THEN
U/D !       Store the direction code into U/D.
#BUFFERS /MOD  Groups of blocks to be copied together.
>R (CONVEY) R>  Copy the remainder blocks which do not fill the pipeline.
0 ?DO      Pipe the rest of block through all the buffers.
#BUFFERS (CONVEY)  Copy #BUFFERS blocks all at once.
LOOP
DROP      Leftover block number.
;

```

If you know the destination block number and do not want to use HOP to specify the number of blocks to be skipped, you can use the following commands to do the copying:

```
<first> <last> TO <destination> CONVEY
```

where 'first', 'last', and 'destination' are block numbers indicating the range of source blocks and the first destination block number.

```

: TO          ( first last -- first last )
              Calculate the blocks to be hopped and store the number in HOPPED.
SWAP        Get 'first' to top of stack.
BL WORD     Read the next number.
NUMBER DROP Convert the number to an integer.
OVER -      The hopping distance.
HOP         Store it in HOPPED.
SWAP       Restore the 'first last' order on data stack.
;

```

18.5. Multiple File Block Copying

F83 Version 2.0 and above was modified so that when screens are copied, it is always read from the in-file and written to the current file. Therefore, it is not necessary to define special commands to copy screens from one file to another. You must remember that when you OPEN a file, you assign the file to both the current file and the in-file. If you open another file using the FROM command, this file becomes the in-file which is always to be read. In the early versions of F83 the role of in-file was not clearly defined, and many block copying commands had to be redefined in the FILES vocabulary. The following discussion applies only to the F83 Versions 1.x.

One of the advantages in using the DOS operating system to host a Forth system is that we can organize the disk storage into named files which help us using the disk storage more conveniently by grouping related screens into separated files. However, it is often necessary to transfer common utility from one file to another. The multiple file screen copying utility in F83 system makes it easy to copy either single screen or a range of screens from one file to another by new versions of COPY and CONVEY. These commands are redefined in the FILES vocabulary so that they can be accessed independent of the existing COPY and CONVEY commands in the FORTH vocabulary.

```

ONLY FORTH ALSO FILES  Make FORTH and ONLY the resident vocabularies and FILES the context and current
DEFINITIONS           vocabulary.

: COPY ( from to -- )  Copy a screen from the FROM file to the current file.  The FROM file must be declared
                        by the FROM xxx commands, where xxx is the FROM file name.
SWAP                  Get the source block number to top of stack.
EXCHANGE             Exchange the FROM file with the current file.
BLOCK                Read the source block from the FROM file.
SWAP                  Get the destination block number to top of stack
EXCHANGE             Restore the current file.
BLOCK                Get the destination block from the current file.
B/BUF CMOVE          Copy the contents of the source screen into destination screen buffer.
UPDATE               Update the destination block so it will be copied back to the current file.
;

: CONVEY              ( first last -- )
                        Copy a range of screens from the FROM file to the current file. The screen range
                        is the current file is offset from that in the FROM file by the number in HOPPED.
['] CONVEY-COPY >BODY Get the parameter field of the word CONVEY-COPY.
@                    The execution address of (COPY).
>R                   Save it on the return stack.
['] COPY              Execution address of the COPY in the FILES vocabulary, which does copy between
                        files.
IS CONVEY-COPY        Vector CONVEY-COPY to the COPY we just defined above.
CONVEY                Now, CONVEY will copy a range of screens from FROM file into the current file
                        because CONVEY-COPY is vectored to the new COPY command.

R> ['] CONVEY-COPY    Restore CONVEY-COPY to the old single file COPY.
>BODY !
;

```

This is an example in using a deferred word to do different thing by vectoring it to different commands. The commands using the deferred word do not have to be change at all.

Chapter 19. Memory Dump

Source code discussed here is in the UTILITY.BLK file, Screens 28 to 30 and KERNEL86.BLK screen 87.

Source code and text data can be displayed or printed using commands like LIST, SHOW, and TYPE at the primitive level. Non-ASCII data like object code and numeric data cannot be displayed conveniently. The dumping utility provided in F83 allows you to review the binary data in a conveniently formatted form. Large area of memory and large numeric data set can be either displayed on terminal or listed on printer.

19.1. The Dumb DUMP

A simple and primitive dump command is included in the kernel of F83 system. It helps you to debug the system before it is fully checked out.

```
: DUMP ( addr len -- ) Dump a range of memory from addr in bytes.
0 DO Set up the loop.
CR Start a new line.
DUP 6 .R SPACE Print the address first.
16 0 DO Dump 16 bytes.
DUP C@ Get one byte.
3 .R Print one byte.
1+ Increment address.
LOOP
16 +LOOP Loop for more lines.
DROP ;
```

19.2. The Smart DUMP

More sophisticated dumping routines present data in both numeric and ASCII forms because in many cases the ASCII data are intermixed with binary data. It is convenient to have both types of display side by side. It is also nice if one can scan the memory forward and backward. The more elaborate dumping utility in F83 has many features not available in other systems.

```
: .2 ( n -- ) Display a 2 digit number followed by a space.
0 Make a double number of n.
<# # # #> Convert two digits.
TYPE SPACE Type two digits with a trailing space.
;

: D.2 ( addr len -- ) Display a line of 2 digit numbers.
BOUNDS
OVER + SWAP Convert addr len to the limit-index format.
?DO Skip if len=0.
I C@ .2 Print one number.
LOOP ;

: EMIT. ( char -- ) Emit one character if it is printable. Otherwise display a period.
127 AND Mask off MSB.
DUP Save a copy of char.
```

```

BL 126 BETWEEN      Is it between 32 and 126, the printable range?
NOT IF DROP ASCII . If not printable, replace char with '.'.
THEN
EMIT                Send either char or '.' .
;

: DLN ( addr -- )   Dump 16 bytes of data starting at addr. Display address first, then 2 sets of
                    8 bytes, followed by the ASCII equivalent.
CR                  New line.
DUP 4 U.R 2 SPACES Display the address.
8 2DUP D.2 SPACE   Display 8 bytes.
OVER + 8 D 2 SPACE Second set of 8 bytes.
16 BOUNDS DO       Scan 16 bytes
  I C@ EMIT        Print ASCII characters.
LOOP               ;

: ?.N ( n1 n2 -- n1 ) If n1=n2, display a downwards pointer, otherwise display the number.
2DUP =             n1=n2?
IF ." \/" DROP     Equal. Display pointer and drop n2.
ELSE 2 .R THEN     Otherwise, display n2.
SPACE              ;

: ?.A ( n1 n2 -- n1 ) If n1=n2, display a 'v' symbol. Otherwise display one character.
2DUP =
IF ." V" DROP
ELSE 1 .R THEN     Display only one character.
;

: .HEAD ( addr len -- addr1 len1 ) Display the header field of a dump, making it easy to index into the data portion
of the dump.
SWAP               Get addr to top of stack.
DUP -16 AND        Mask off the least significant 4 bits in the address.
SWAP               Second copy of address.
15 AND             Preserve only the lower 4 bits.
CR 6 SPACES        Skip the address field.
8 0 DO I ?.N LOOP Print numeric field markers.
SPACE
16 8 DO I ?.N LOOP Second set of field markers.
SPACE
16 0 DO I ?.A LOOP ASCII field markers.
ROT +              Leave addr1 and len1 on stack, enabling full line display.
;

: DUMP ( addr len -- ) Dump a range of memory specified on stack. The dump is always in HEX, but the
current base is preserved.
BASE @ -ROT        Save base under addr.
HEX                Use hexadecimal conversion.
.HEAD              Print the display header.
BOUNDS DO          Scan the memory range.
  I DLN            Display a line.
  KEY? ?LEAVE     Quit if any key is pressed.
  16 +LOOP        16 bytes per line.
BASE !            Restore the original base.
;

: DU ( addr -- addr+64 ) Dump 64 bytes at the specified address and increment the addr so that next block
of memory can be display next
DUP 64 DUMP        Dump 64 bytes in a block.
64 +              Increment addr.
;

: DL ( line# -- )    Dump the specified line in the current screen to verify non-printable characters.
C/L *              Starting character count.
SCR □LOCK          Get the current block buffer address.
+                  Address of the specified line.
C/L DUMP           Dump one line.
;

```

Chapter 20. Decompiler

The source code of the decompiler is in UTILITY.BLK, Screens 31 to 42.

A decompiler is a program which can translate an object program in machine executable form back to the source program a human being can read. This is normally impossible because traditional compilers produce more object code than source code, showing a 'code expansion'. However, decompilation is rather easy in Forth because there is an one-to-one correspondence between the source code and object code in Forth, as a word or a command in Forth is compiled to an execution address in the object. Exception to this one-to-one relationship occurs in the control structures and some other special compiler directives. A Forth decompiler must be able to deal with these exceptions.

The final command doing the decompilation is SEE, which is used in the following fashion:

```
SEE <name>
```

where <name> is the name of a Forth command. The decompiled source code will be displayed on the terminal as a sequence of Forth commands similar to the original source code.

20.1. Positional Case Defining Command

This is the simplest among the CASE control structures effecting an n-way branching. In the parameter field of the case command, there are a sequence of execution addresses. One address in the list is selected by the number on the stack and executed. In this version of case, additional range checking is also implemented for safety.

```
: OUT ( n pfa -- )      Display an error message if the index is out of range for a case word whose parameter
                        field address pfa is on th stack.
CR ." Subscript out of Initial error report.
range on "
DUP BODY>              Get the code field address first.
>NAME                  Then the name field address.
.ID                     Print the name of the case word
.." Max is " ?          Print the range allowed by the case word.
." tried " .           The index tried.
QUIT                    Abort.
;

: MAP ( n pfa -- addr ) Given the pfa of a case word and the index n for case selection, return the execution
                        address selected. Abort if the index is out of range.
2DUP @                 Fetch the range from pfa
U< IF                  Is the index n within range?
2+ SWAP 2* +           Address of the execution code.
ELSE OUT               Abort if out of range.
THEN
;
```

The case defining command is CASE: . It is used in the same way as a regular colon defining command. The name of the new case command follows CASE:, and then a list of regular Forth

commands followed by ; . A range number should be on the stack before CASE: is encountered to specify the number of branches in the case command.

```
n CASE: <name> <list of FORTH words> ;
```

When the new case word <name> is executed, it uses the top item on the stack as an index to select one of the Forth commands in the list and executes it.

```
: CASE: ( n -- )      A positional case statement. The range n is used for error checking. At runtime,
                     the nth word is executed, depending on the value on stack when executed.
CONSTANT             Compile the range n as a constant.
HIDE                 Smudge the name field as : would do.
]                   Now, use the colon compiler to compile the cases. Compilation will be terminated
                     by the ; command.
DOES>               ( index -- ) At runtime, use the index to find the execution address among the
                     compiled cases and execute it.
MAP                 Return the address pointing to one of the cases compiled.
PERFORM             Execute it.
;
```

Because of the multitude of special compiler directives used in the F83 system, we need a big case statement to handle all the exceptions. This CASE: defining command, though very simple by borrowing facilities in the colon compiler, is extremely powerful to take care of a wide range of n-way branching structures. The limitation is that all the cases must be defined as single commands. This is not a problem because it is a good practice to modularize the cases into single testable commands before putting them into a big case structure.

20.2. Associative Defining Command

An associative commands also has a list of values in its parameter field. At runtime a value on the top of the data stack is compared with the list of values in the associative command. If a match is found, the index of the matched value in the parameter field is returned. This is the inverse of an array.

```
: ASSOCIATIVE: ( n -- ) Store the maximum range of the associative array as a constant. The values will
                       be compiled explicitly by the , (comma) command.
CONSTANT             Compile n as a constant.
DOES>               ( value -- index ) Search value in the parameter field and return the index if
                       found.
DUP @               Get the range n.
-ROT                ( n value pfa -- )
DUP @               Get another copy of n.
0 DO                Scan the list in parameter field.
  2+                Next number in the list.
  2DUP @ =          Match?
  IF                Yes.
    2DROP DROP      Clear the stack.
    I 0 0           Put on the index and flags.
  LEAVE             Quit the loop.
THEN
LOOP
2DROP               Return only the index. If no match, return n+1.
;
```

Associative and case commands are using to build tables to drive the decompiler.

20.3. Decoding Different Classes Of Commands

There are several types or classes of commands which execute differently and thus require different actions to decode them. The decompiler does not have to do much other than printing the names of the commands and taking care of the additional information compiled into the object code with the command.

```
DEFER (SEE)           A deferred word vectored to decompile deferred words.
HIDDEN DEFINITIONS   Hide all the supporting words in the HIDDEN vocabulary.

: .WORD ( ip -- ip+2 ) Display the name of a colon word and increase the ip by 2.
  DUP @              Execution address.
  >NAME .ID          Print the name.
  2+                 ;

: .INLINE ( ip -- ip+4 ) Display an inline literal and its value.
  .WORD             Print the name.
  DUP @ .           Print the value.
  2+                 Increment ip again.
;

: .BRANCH ( ip -- ip+4 ) Display a word that has an inline branch address.
  .WORD             Print the name of the branch word.
  DUP @ OVER - .    Print the branching offset.
  2+                 Increment ip again.
;

: .QUOTE ( ip -- ip+4 ) Handle the special case of COMPILE xxx .
  .WORD             Print COMPILE.
  .WORD             Print name of xxx.
;

: .STRING ( ip -- ip' ) Display a word with inline string argument.
  .WORD             Print name.
  COUNT 2DUP TYPE   Type out the inline string.
  SPACE
  +                 Add the string length to ip to skip over the inline string.
  EVEN              Align the cell boundary.
;

: DOES? ( ip -- ip' f ) Increment simulated ip and return a true flag if DODOES is called as the first
  instruction in the parameter field.
  DUP 3 +           Skip over the CALL DODOES code.
  SWAP @            Get the machine code.
  DOES-OP =         Is it a CALL instruction?
;
;                 Return the flag.
```

Association Table	Execution Table
(LIT)	.INLINE
?BRANCH	.BRANCH
BRANCH	.BRANCH
(LOOP)	.BRANCH
(+LOOP)	.BRANCH
(DO)	.BRANCH
COMPILE	.QUOTE
(.)	.STRING
(ABORT)	.STRING
(;CODE)	(;CODE)
UNNEST	.UNNEST
(")	.STRING
(?DO)	.BRANCH
(;USES)	.FINISH
All others	.WORD

Figure 20.1 Decoding different types of commands.

```

: .(;CODE) ( ip -- ip' )  Decompile a DOES> word.
  .WORD                  Print name.
  DOES?                 Is it a DOES> word?
  IF ." DOES> "         Yes. Print DOES>.
  ELSE DROP FALSE       Otherwise, replace ip with a 0.
  THEN
;

: .UNNEST ( ip -- 0 )    End of a colon definition.
  ." ; "                Print ; .
  DROP 0                Replace ip with 0.
;

: .FINISH ( ip -- 0 )   Display current word and quit.
  .WORD
  DROP 0                Replace ip with 0, indicating end of decompilation.
;

```

20.4. Sorting and Execution Tables

The associative commands EXECUTION-CLASS collects all the special cases that must be decompiled differently from normal Forth commands like DUP, +, etc. At runtime if the address pointed to by IP matches the address of a command in this table, the corresponding index will be returned. This index will be used to select an execution address in the following case table and the appropriate decompilation function will be invoked. These two tables make up the basic mechanism of this table driven decompiler.

```
14 ASSOCIATIVE:          14 classes of special compiler words are to be processed.
EXECUTION-CLASS
' (LIT) ,                Each execution address must be compiled explicitly using , .
' ?BRANCH , ' BRANCH , ' (LOOP) , ' (+LOOP) ,
' (DO) , ' COMPILE , ' (." ) , ' (ABORT" ) ,
' (;CODE) , ' UNNEST , ' (" ) , ' (?DO) ,
' (;USES) ,

15 CASE: .EXECUTION-CLASS  A giant case statement handles the special case decompilation. Each entry
                          corresponds to an entry in the EXECUTION-CLASS associative table. In case
                          of no match, .WORD will be executed, assuming a normal Forth word.
.INLINE .BRANCH .BRANCH .BRANCH .BRANCH .BRANCH
.QUOTE .STRING .STRING .(;CODE) .UNNEST .STRING
.BRANCH .FINISH .WORD
;
```

CASE: must end with a ; , because it uses the colon compiler to do the compiling.

20.5. Decompiling Different Command Classes

When the decompiler is given a command to decompile, it has to determine first which type this command is. If the command is simple, like constant or variable, all the decompiler has to do is to tell you its name. Decompilation is only needed for the more complicated colon commands. Therefore, we need another case and associative table pair to handle different types of commands.

```
: .PFA ( cfa -- )      Given the code field address of a colon word, decompile the list of execution
                      addresses in its parameter field.
>BODY                Transform cfa into pfa.
BEGIN                Scan the parameter field.
  DUP @              Get an execution address.
  EXECUTION-CLASS    Identify which class the word belongs.
  .EXECUTION-CLASS    Decompile it.
  DUP                Dup the ip or the flag.
  0= KEY? OR         If it is 0 or a key was pressed, terminate the loop.
  UNTIL              Otherwise continue decompiling.
  DROP              Last flag.
;

: .IMMEDIATE ( cfa -- )  Indicate whether the current word is immediate or not.
>NAME                Get to the name field.
C@                  The count byte at the beginning of the name field.
64 AND              Is the precedent bit set?
IF                  Yes.
  ." IMMEDIATE"      Print that it is immediate.
THEN
;

: .CONSTANT ( cfa -- )  Decompile a constant and print its value.
DUP >BODY ?         Print its value first.
```

```

." CONSTANT "          Print the type.
>NAME .ID              And the name.
;

: .VARIABLE ( cfa -- )  Decompile a variable. Print its location and value.
DUP >BODY .            Print its location.
." VARIABLE "          Type.
DUP >NAME .ID          Name.
." Value = " >BODY ?   Value.
;

: .: ( cfa -- )        Decompile a colon definition.
." : "                 Print the almighty colon.
DUP >NAME .ID          Name.
2 SPACES
.PFA                   Decompile the parameter field.
;

: .DOES> ( cfa --)     Decompile a word defined by a CREATE-DOES> defining word.
DUP >NAME .ID          Name.
." DOES> "            Type.
BODY>                  Address of the high level runtime code or the interpreter.
.PFA                   Decompile the interpreter.
;

: .USER-VARIABLE       ( cfa -- )
                        Decompile a user variable. Print its offset from the base of user area and its
                        current value.
DUP >BODY ?            Offset.
." USER VARIABLE "    Type.
DUP >NAME .ID          Name.
." Value = " >IS .    Value.
;

: .DEFER ( cfa -- )    Tell the user that this is a deferred word and decompile its current definition.
." DEFERRED "          Type.
DUP >NAME .ID          Name.
." IS "                Deferred.
>IS @ (SEE)            Decompile the vectored word.
;

: .USER-DEFER          ( cfa -- )
                        Tell the user that it is a user deferred word and decompile its current definition.
." USER DEFERRED "    Type.
DUP >NAME .ID          Name.
." IS "                Deferred.
>IS @@ (SEE)          Decompile the current definition.
;

: .OTHER ( cfa -- )    Decompile words whose type is not known.
DUP >NAME .ID          Print the name first.
DUP @                  Contents of code field.
OVER >BODY =           Is it pfa?
IF                      Yes. Must be a code definition.
  DROP
  ." is code"          Print type.
  EXIT                 Quit because we have no disassembler.
THEN
DUP DOES? IF           Is it a 'does' word?
  DROP
  DOES> EXIT           Decompile it as a DOES> word.
THEN
2DROP
." is unknown"         Tell the truth also.
;

```

20.6. Command Classification

Different classes of commands are characterized by the inner interpreters which execute the commands. Commands of the same class share the same inner interpreter, whose address is stored in the code field of these commands. Inner interpreters are code routines in the Virtual Forth

Computer and generally they do not have names and cannot be referred to directly. However, we can find the address of an inner interpreter by looking at the code field of any command in the corresponding class.

```

6 ASSOCIATIVE:          Categorize different classes of words that the decompiler will handle. For
DEFINITION-CLASS       each class defined by the same defining word, the code field is identical.
                        Thus standard classes can be recognized.
' QUIT @ ,             Colon word.
' 0 @ ,               Constant.
' SCR @ ,             Variable.
' BASE @ ,           User variable.
' KEY @ ,            Deferred word.
' EMIT @ ,          User deferred word.

7 CASE: .DEFINITION-CLASS Define a table of routines to handle decompilation of each class of definition.
.:      Colon word decompiler.
.CONSTANT
.VARIABLE
.USER-VARIABLE
.DEFER
.USER-DEFER
.OTHER      Code and DOES> words
.;

```

20.7. The Decompiler SEE

```

: ((SEE)) ( cfa -- ) Given an arbitrary code field address, decompile it based upon its definition
                    class. Upon completion, indicate whether or not the word is immediate.
CR DUP DUP @      Get the contents of the code field.
DEFINITION-CLASS Determine the type of definition.
.DEFINITION-CLASS Decompile it.
.IMMEDIATE        If it is an immediate word.
;

' ((SEE)) IS (SEE) (SEE) is a deferred word so that .DEFER and .USER-DEFER can make use of it before
                    it is actually defined. Now patch it in.
FORTH DEFINITIONS All the above supporting word are defined in the HIDDEN vocabulary. Now switch
                    context back to FORTH and declare it the current vocabulary so that the decompiler
                    word SEE will be available to the user in the FORTH vocabulary.

: SEE ( -- )      SEE <name> decompiles the word whose name follows SEE.
'                Get the code field address of the word <name>.
(SEE)            Decompile it
;

```

Association Table

NEST
DOCONSTANT
DOCREATE
DOUSER-VARIABLE
DODEFER
DOUSER-DEFER
All others

Execution Table

"
.CONSTANT
.VARIABLE
.USER-VARIABLE
.DEFER
.USER-DEFER
.OTHER

Figure 20.2 Decompiling different types of commands.

Chapter 21. Printing Utility

The code discussed in this chapter is in UTILITY.BLK, Screens 43 to 48.

The printing utility in F83 is designed for an EPSON printer. Using the compressed character size in the EPSON printer, 6 screens can be squeezed on a single 8.5" by 11" sheet of paper. You can print 6 consecutive screens to a page, or 3 screens of source code with 3 corresponding shadow screens to a page, which is nice to show source and comments side by side. To use these high density printing formats, it requires that your printer can print 128 characters per line. If your printer cannot handle 128 characters per line, the old faithful TRIAD should be used to print 3 screens to a page.

21.1. Variables and Setup

```
: EPSON ( -- )          Set up the EPSON MX-80 printer to print 132 columns per line.
CONTROL O EMIT        Send control O to printer, initialize compressed mode.
;

DEFER INIT-PR         Printer initialization. Default is EPSON printer.
' NOOP IS INIT-PR
DEFER FOOTING         Print message at the bottom of a page.
66 CONSTANT L/PAGE   Lines per page.
0 CONSTANT LOGO      The screen number of the logo screen where copyright notice can be stored and
                     displayed.
VARIABLE #PAGE       Current page number during printing.

: PAGE ( -- )        Do a form-feed and start a new page. It also increments the page number and resets
                     line and column numbers.
DOES>                Vectors word.
PERFORM              Do the form-feed in place of NOOP.
1 #PAGE +!           Increment page number.
#LINE OFF            Reset line number.
#OUT OFF             Reset column number.
;
PAGE                 Initialize itself.

: FORM-FEED ( -- )   EPSON form feed control character.
CONTROL L EMIT
;

: (PAGE) ( -- )     Print enough linefeeds to get to the next page.
L/PAGE               66 lines.
#LINE @              Current line number.
OVER MIN ?DO        Use the lesser of the two.
CR                  Out put that many linefeeds.
LOOP ;

' (PAGE) IS PAGE

: (SEMIT) ( char -- ) Send a character to either printer or the console, but not both.
PRINTING @ IF       If printing flag is true,
(PRINT)              Send to printer.
ELSE (CONSOLE)      Otherwise, send to console.
THEN ;

HIDDEN DEFINITIONS  HIDDEN is a vocabulary collecting words for internal usage to avoid cluttering
                     up FORTH vocabulary with all kinds of junk words.

CREATE SCR#S 14 ALLOT An array to hold a screen count and up to six screen numbers to be printed.

: PR-START ( -- )   Initialize all printing functions.
```

```

PRINTING ON          Start the printer.
#LINE OFF           Top of page.
['] (SEMIT) IS EMIT Re-vector EMIT to send characters to the printer.
SCR#S OFF           Reset screen numbers.
1 #PAGE !           Page number starts from 1, not 0.
INIT-PR             Initialize the printer.
;

: PR-STOP ( -- )    Stop the printer as the character output device.
['] (EMIT) IS EMIT Vector EMIT to (EMIT) to send characters to the CRT terminal.
PRINTING OFF        Turn off printing flag.
;

```

Vectoring the output command EMIT allows us to change the function of EMIT dynamically. The power of vectored execution is quite vividly demonstrated here. The output character string can be directed to any output device by defining individual device output commands and store appropriate execution address in the parameter field of EMIT. EMIT was defined as a deferred command, which takes an address in the parameter field and executes it. PR-START and PR-STOP simply change the address in the parameter field of EMIT and the output can be directed at will.

21.2. Print Two Screens Side By Side

```

: TEXT? ( scr# -- f ) Given a screen number, return true if the first character in the screen is printable
                        and the screen is not blank.
BLOCK DUP C@          Get the first character in screen.
BL ASCII ~ BETWEEN   Is this character printable?
IF                    Yes.
  B/BUF -TRAILING     Count of non-blank characters.
  NIP                 Drop the buffer address.
  0<>                 Return true if not a blank screen.
ELSE                  First character nonprintable.
  FALSE              Push the false flag.
THEN                  ;

: PR ( scr# -- )      Add a screen to the SCR#S array and also increment the screen count at the beginning
                        of SCR#S.
DUP CAPACITY >=      Is scr# out of range?
IF DROP LOGO THEN    Yes. Substitute with logo screen.
1 SCR#S +!            Increment the screen count.
SCR#S DUP @           Fetch the screen count.
2* + !                Store scr into the appropriate cell in the SCR#S array.
;

: 2PR ( scr1 scr2 line# Print the specified line from two screens given on the stack. First the line
-- )                  in scr1, followed by the line in scr2.
CR DUP 2 .R SPACE     Print the line number.
C/L * >R              Save the character number.
PAD 129 BLANK         Clear the PAD buffer.
SWAP BLOCK            Buffer address of scr1.
R@ +                  Address of first character in the specified line.
PAD C/L CMOVE         Copy one line from scr1 to PAD.
BLOCK R> +            Address of the first character of the line in scr2.
PAD C/L + 1+          Second half of PAD buffer with an additional space.
C/L CMOVE             Copy the line from scr2.
PAD 129 -TRAILING     Print the entire 129 characters.
TYPE
;

: 2SCR ( scr1 scr2 -- ) Print 2 screens across on a page. Call 2PR on a line by line basis.
CR CR 4 SPACE         Space between screens.
OVER 4 .R             Print header of scr1.
61 SPACES DUP 4 .R   Header of scr2.
16 0 DO              Scan down 16 lines.
  I 2PR              Print.
LOOP

```

```
2DROP          Discard the screen numbers.
;
```

21.3. Print 6 Screens on a Page

To print 6 screens on one page, one has to manage the screens and also put headings and footings on the page, making it look good and convenient to read.

```
: P-HEADING ( -- )      Print a heading for each new page.
CR CR 5 SPACES          Top blank.
." page#" #PAGE ?      Print page number.
8 SPACES
FILE? CR               Print the file name.
;

: P-FOOTING ( -- )      Print the footing for each page and also do form feed.
CR CR 58 SPACES        Some space.
." Forth 83 Model"     Footing.
PAGE                   Form feed.
;

' P-FOOTING IS FOOTING
```

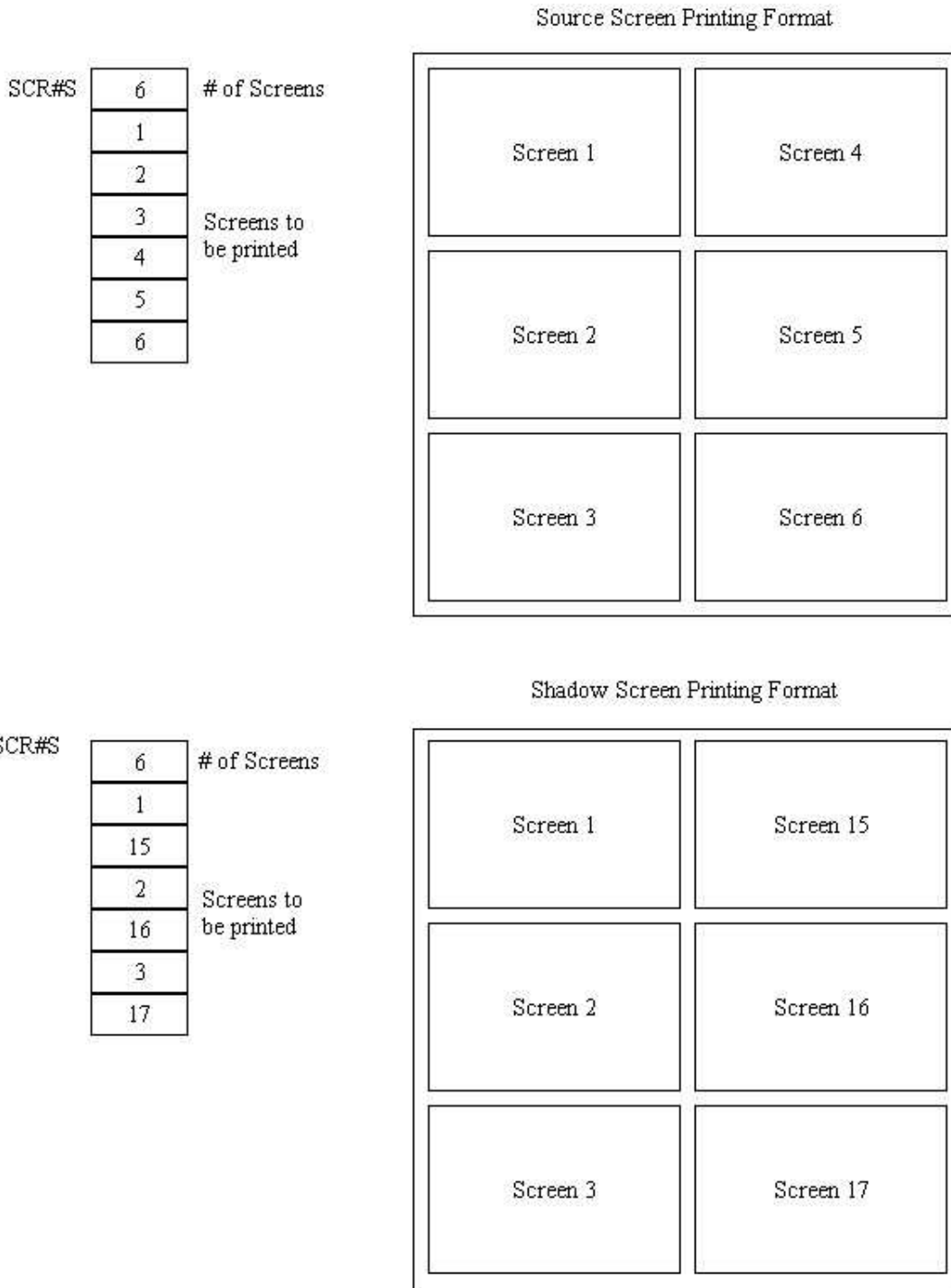

Figure 21.1 Two printing formats.

```

: PR-PAGE ( -- )      Print a page worth of screens, 6 to a page without shadows.
P-HEADING            Print the heading.
SCR#S OFF            Reset the screen count.
SCR#S 2+             Address of first screen number to be printed.
3 0 DO              3 screens per column.
  DUP @             Screen number for 1st column.
  OVER 6+ @         Screen number for 2nd column.
  2SCR              Print two screens side by side.
  2 +              Next cell in SCR#S array.
LOOP
DROP                Discard the SCR#S pointer.

```

```

FOOTING          Print footing.
;

: PR-S-PAGE ( -- )  Print a page worth of screens with shadows   Source screen on the left and shadow
                    screens on the right.

P-HEADING
SCR#S OFF
SCR#S 2+
3 0 DO
  DUP @          Screen number of source.
  OVER 2+ @     Screen number of shadow.
  2SCR          Print.
  4 +          Next pair of screens.
LOOP DROP
FOOTING
;

: PR-FLUSH ( -- f )  Fill the SCR#S array with LOGO screen if a page is partially filled.  Return true
                    flag if there is more to print.
SCR#S @         Screen number.
DUP IF         Yes, more screens to print.
BEGIN
  SCR#S @       Screen number again.
  5 <          If screen number is less than 5, the SCR#S must be filled.
  WHILE 0 PR    Fill the array with 0's.
  REPEAT
  LOGO PR       Put the LOGO screen as the last.
  THEN
  0<>          Return the flag.
;

```

21.4. SHOW

There are two versions of SHOW defined in the F83 system to print screen files. One version prints consecutive screens and the other prints 3 screens of source with their respective shadows. The first version is defined in the FORTH vocabulary and the second one in the SHADOW vocabulary so that they are both accessible to you.

```

1 20 SHADOW SHOW   Print source with shadows.
1 20 FORTH SHOW    Print source without shadow.

FORTH DEFINITIONS  Define the SHOW without shadow screens in the FORTH vocabulary.

: SHOW ( first last -- )  Print 6 consecutive screens on a page.  Blank screens are not printed.
[ HIDDEN ] PR-START     Call PR-START in the HIDDEN vocabulary to turn on the printer.
1+ SWAP DO              Run through the range of screens.
I TEXT?                 Is this screen printable?
IF I PR THEN            Yes.  Include it in the SCR#S array to be printed.
SCR#S @                 Get the number of screens in SCR#S array.
6 =                     Full?
IF PR-PAGE THEN        Yes.  Print one page.
LOOP
PR-FLUSH                Fill the last page.
IF PR-PAGE THEN        Print it if necessary.
PR-STOP                 Turn off the printer.
;

SHADOW DEFINITIONS  Now get the SHADOW vocabulary to define the second version of SHOW with shadow
                    screens.

: SHOW ( first last -- )  Print 3 source screens with their shadow screens.
[ HIDDEN ALSO ]         Push HIDDEN into the resident vocabulary array so that other vocabulary can be
                        invoked while HIDDEN is still available for searching.
PR-START                Turn on printer.
1+ SWAP DO
I TEXT?                 A valid source screen?
IF                       Yes.
I PR                     Put it in SCR#S array.
[ SHADOW ]              We need some words in the SHADOW vocabulary.

```

```

>SHADOW          Get the number of shadow screen.
PR              Put it in SCR#S also.
THEN
SCR#S @ 6 =     End of SCR#S?
IF PR-S-PAGE THEN Yes. Print page with shadows.
LOOP
PR-FLUSH
IF PR-S-PAGE THEN
PR-STOP
;

ONLY FORTH ALSO Reset the vocabulary order and make FORTH a resident vocabulary as well as the
DEFINITIONS     context (transient) and current vocabulary.

: LISTING ( -- ) Print the entire current file with shadow screens.
0              First source screen.
CAPACITY      Last screen in current file.
2/ 1-        Last source screen in file.
[ SHADOW ]    We want the SHOW with shadow, which is in SHADOW vocabulary.
SHOW          Print the entire file in the shadow screen format.
;

```

Source screens printed with their corresponding shadow screens side by side serve very well as program reference and documentation.

Part IV. 8086 Specific Utilities

Chapter 22. Debugger

The source code of the debugger is in CPU8086.BLK, Screen 18 to 20, and in UTILITY.BLK, Screen 49 to 51.

The debugger in F83 is designed to let you single step through the execution of a high level command. To invoke the debugger, type

```
DEBUG xxx
```

where xxx is the name of the colon command you want to trace. DEBUG patches the NEXT routine with a special routine DEBNEXT to display the contents of the data stack at every step when DEBNEXT is encountered. The real single step action occurs only when the command xxx is executed. When xxx is executed, you will get a single step trace showing the commands within xxx that is about to be executed, and the contents of the data stack. At each step, you can use the commands C (continue), F (Forth), and Q (quit) to control the stepping process.

F allows you to execute any Forth command to poke around, until you type

```
RESUME
```

to continue with the debugging. Q stops the debugging process and restores xxx to its original condition.

22.1. Low Level Supporting Commands

VOCABULARY BUG	The vocabulary holding all the debugger supporting words.
BUG ALSO DEFINITIONS	Declare BUG as the current vocabulary to add new words to it.
VARIABLE 'DEBUG	A variable holding the code field address of the word to be traced.
VARIABLE <IP	Lower limit of tracing range for IP, the interpretive pointer.
VARIABLE IP>	Upper limit of IP for tracing.
VARIABLE CNT	Count of tracing through debug NEXT.
ASSEMBLER HEX	Invoke the assembler to use the LABEL word in ASSEMBLER vocabulary.
LABEL FNEXT	A machine code subroutine restoring NEXT back to its original form.
0AD # AL MOV	AD is the machine code of indirect jump.
AL >NEXT #) MOV	Put this jump code in >NEXT.
D88B # AX MOV	The address of the real NEXT code.
AX >NEXT 1+ #) MOV	Put this address after the jump code. This is the original NEXT
.RET	
LABEL DNEXT	A copy of NEXT that gets executed during debugging in place of the regular NEXT.
AX LODS	Load IP into AX and increment IP by 2.
AX W MOV	Copy IP into W register.
0 [W] JMP	Indirect jump through W register.
LABEL DEBNEXT	The debugger's version of NEXT. If IP is between <IP and IP>, the contents of the execution variable 'DEBUG are executed. The word pointed to by 'DEBUG must

```

drop the IP pushed on data stack by DEBNEXT and must be terminated by PNEXT for
more tracing.
<IP #) IP CMP U> IF IP greater than <IP?
IP> #) IP CMP
U<= IF IP less than IP>? If both true, do the following:
CNT #) AL MOV
AL INC
AL CNT #) MOV Increment CNT.
2 # AL CMP AL=2?
0= IF Yes. Do the following every other time.
AL AL SUB
AL CNT #) MOV Clear CNT counter.
FNEXT #) CALL Restore the original NEXT.
IP PUSH Push current IP on data stack.
'DEBUG #) W MOV Copy the execution address in 'DEBUG to W register.
0 [W] JMP Indirect jump through W. The trace routine is executed.
THEN
THEN
THEN
DNEXT #) JMP None of the about cases are true. Execute the regular NEXT.

CODE PNEXT ( -- ) Patch the regular NEXT in FORTH to jump to DEBNEXT. This puts us in the debug
mode and allows for tracing single steps.
E9 # AL MOV E9 is the machine code of JMP.
AL >NEXT #) MOV Copy this code into >NEXT.
DEBNEXT >NEXT 3 + - #
AX MOV
AX >NEXT 1+ #) MOV Copy the address of DEBNEXT to the cell next to >NEXT. >NEXT is now patched to
execute DEBUG by jumping to DEBNEXT.

NEXT
END-CODE

FORTH DEFINITIONS Next instruction must be defined in FORTH vocabulary.

CODE UNBUG ( -- ) Restore FORTH's NEXT to its original condition and disable tracing.
FNEXT #) CALL Call FNEXT to fix NEXT.
NEXT
END-CODE

```

22.2. High Level Trace Commands

```

BUG ALSO DEFINITIONS Put the following words in the BUG vocabulary. Only the very last word TRACE
needs to be in the FORTH vocabulary for ease of accessing.

: L.ID ( nfa len -- ) Print the name of a word left justified in a field of at least ten characters.
SWAP DUP .ID Print the name.
DUP NAME> Get the code field address.
1- - + SPACES Fill in spaces.
;

VARIABLE SLOW When true, step continuously. When false, single step.
VARIABLE RES When true, resume debugging.

: (DEBUG) ( low-addr hi-addr -- )
Prepare to trace the words between the specified range for IP pointer.
1 CNT ! Store 1 into CNT to run DEBNEXT every other time through NEXT.
IP> ! Set the high limit of IP.
<IP ! Set the low limit.
PNEXT Patch NEXT to DEBNEXT.
;

: 'UNNEST ( pfa -- pfa' )
From the starting address of a parameter field, find the end of this field indicated
by UNNEST.

BEGIN
1+ DUP @ Get the execution address of the next word.
['] UNNEST Is it UNNEST?
UNTIL Exit if UNNEST is found and leave its address on stack.
;

: TRACE ( ip -- ) Display the contents of the data stack and the name of the next word about to
execute in the routine being debugged. It then waits for a key unless SLOW is
true. If the key is C, F, or Q, special action is taken; otherwise, a single step

```



```

>R          is performed.
.S          Save ip.
R>         Display the data stack.
CR @ >NAME  Restore ip.
10 L.ID    Get the name field of the word pointed to by ip.
SLOW @ NOT Print its name.
KEY? OR    If SLOW is false,
IF         or a key is received, do the following:
  SLOW OFF Reset SLOW flag.
  RES OFF  Reset RESume flag also.
  ."  -->" Print a prompting message.
  KEY      Wait for a key here.
  UPC      Change the key code to upper case always.
  ASCII C OVER = IF If the key is C,
  SLOW @ NOT complement SLOW.
  SLOW ! THEN
  ASCII F OVER = IF If this key is F,
  DROP      throw away the key code,
  BEGIN     and entry a Forth interpreter loop.
  QUERY RUN Interpret any Forth command.
  RES @     Continue if RES is false.
  UNTIL
  THEN
  ASCII Q OVER = If the key is Q,
  ABORT" Unbug" abort debugger.
  DROP THEN
  PNEXT      Patch NEXT again to continue tracing the next word.
;

' TRACE 'DEBUG ! Vector 'DEBUG to execute TRACE. This is the function of DEBNEXT.

FORTH DEFINITIONS Put the final debugger commands in the regular FORTH vocabulary so that the user
can invoke it conveniently. Other debugging words are hidden in the BUG
vocabulary.

: DEBUG ( -- ) Patch NEXT to DEBNEXT and set the range of IP to be debugged.
'          Get the execution address of the next word following DEBUG.
2-        Convert cfa to pfa.
DUP [ BUG ] 'UNNEST Find the IP range.
(DEBUG)   Set IP range and patch NEXT.
;

: RESUME ( -- 0 ) Turn on RES to enable tracing to continue.
[ BUG ] RES ON Set RES flag.
0           Leave a dummy stack item to replace the key code dropped.
PNEXT      Patch NEXT to continue debugging.
;

ONLY FORTH ALSO Re-initialize the vocabulary searching order.
DEFINITIONS

```

Chapter 23. Multitasker

The source code of the multitasker is in CPU8086.BLK, Screen 22-23, and in UTILITY.BLK, Screen 52-54.

23.1. Multitasking

Multitasking is the technique to use one computer to do several things at the same time. Most of the microcomputers run rather inefficiently in the single user, interactive mode, because the computer wastes most of its time in waiting you to type in commands. This waiting time can be utilized to perform useful work, like printing a long file, keeping a timer clock, watching over the heater or the air conditioner and other instruments, etc. If properly scheduled, all these activities can be handled by a single computer, allocating each task sufficient time to do its work and still satisfies your programming needs.

Most mainframe computers and minicomputer operating systems have the multitasking function and can support many users and tasks to run at the same time. They use rather complicated hardware and software to schedule and run the tasks, and to manage a host of peripheral devices like disk drives, tape drives, printers, plotters, etc. Scheduling and resource allocation are big headaches in these operating systems, contributing a fair share to the complexity in the operating system.

People generally conceive Forth as a toy language only suitable for single user microcomputers. This is probably due to the limited capability presented in the public domain figForth model, which has become the most widely distributed Forth dialect. However, in many more expensive commercial Forth implementations, especially those developed by Charles Moore himself and later marketed by Forth, Inc. under the trade name polyForth, multitasking was a standard feature using the very simple but effective round-robin scheduling technique.

F83 also includes the elementary commands to implement multitasking. The basic system design takes the task switching into consideration, so that tasks can be easily added to the system when needed. Task switching is very fast because of the brevity of code involved. Here we will go through the entire system to describe the multitasker in great details.

23.2. User Variables and the User Area

Special commands managing multitasking or multiuser Forth system are collected in a special

vocabulary USER. Some of them have the same names but different functions as other regular Forth commands. They have to be used with care. They allocate space for user variables in the user area which is a unique memory area for every task in the system.

```
VARIABLE #USER          Count of the number of user variables allocated in a user area.
VOCABULARY USER        Declare the user vocabulary.
USER DEFINITIONS       Put all subsequent words in the USER vocabulary.

: ALLOT ( n -- )       Allocate space in the user area for a task.
#USER +!               Move the user area pointer forward for n bytes.
;

: CREATE ( -- )        A special header builder for user variables.
CREATE                 Build a regular header.
#USER @ ,              Compile the current user area pointer in the parameter field, to be used as the
;USES                  offset of the user variable from origin of the user area.
DOUSER-VARIABLE ,     Get the code field address of the new user variable.
                       Patch the code field using DOUSER-VARIABLE as the runtime interpreter for user
                       variables.

: VARIABLE ( -- )      New defining word for user variables.
CREATE                 This is the newly defined CREATE.
2 ALLOT                Allocate two bytes in the user area, not on top of dictionary.
;                       Allocate two bytes in the user

: DEFER ( -- )         New defining word for deferred words in the user area.
VARIABLE               Create a new user variable.
;USES                  Patch code field with
DOUSER-DEFER ,         address of the runtime routine DOUSER-DEFER.
```

When tasks are switched, the environment of the task currently under execution must be preserved before the task is put to sleep, so that when the task is woke up the next time around it will be able to pick the execution sequence where was left off and continue the task until finished or put to sleep again. What defines the environment of a task is a set of parameters stored in a set of 'user variables' and an area where the data stack and the return stack used by the task are allocated. Each task must have its own copy of these user variables and stacks. As the essential information are stored independently for each task, task switching becomes very easy because only a minimal amount of information has to be preserved explicitly during task switching.

Following is the list of user variables needed in every task:

Table 23.1. User Variables

TOS	Top of data stack.
ENTRY	Entry point to be jumped to when the task is activated.
LINK	Point to next task in the round- robin circle.
SP0	Origin of the data stack.
RP0	Origin of the return stack.
DP	Top of dictionary.
#OUT	Number of characters emitted.
#LINE	Number of lines typed.
OFFSET	Block offset from block 0 in the current file.
BASE	Numeric base for I/O conversion.
HLD	Point to the last character converted in the PAD buffer.
FILE	Point to FCB (file control block) of currently opened file.
IN-FILE	Point to the FCB of the input file.
PRINTING	A flag. True if printer is active.
EMIT	Send a character to the output device currently active.

One should note that these user variables have their names in the main dictionary while the parameters are stored in the user area. Only one copy of the names needs to be defined. Every user or task will have its own copy of the user variables. The functions of these user variables will become apparent in the following sections.

23.3. Pause and Restart

PAUSE and RESTART are the two most crucial commands in the task switching process. (PAUSE) stops the current task and passes control of the CPU to the next task in the round-robin loop. It saves all necessary information in the user area so that the task can continue the next time it gains the control of the CPU.

```

CODE (PAUSE)                Stop executing the current task and pass control to the next task.
IP PUSH                    Save the Interpretive pointer on the data stack.
RP PUSH                    Save the return stack pointer.
UP #) BX MOV               Fetch the user area pointer into BX register.
SP 0 [BX] MOV             Save the data stack pointer in user variable TOS.
BX INC BX INC
BX INC BX INC             Increment BX and point it at the user variable LINK.
0 [BX] BX ADD             Calculate the address of the user area from the offset in LINK.
BX INC BX INC             Now point to the ENTRY user variable of the next task.
BX JMP                    Execute the next task.
END-CODE

CODE RESTART                The reverse of (PAUSE). Retrieve the stored information and start executing the
                           task left asleep during the last pass.
-4 # AX MOV               Store -4 in the AX register for later use.
BX POP                    Pop the LINK address of the next task to be waked up.
AX BX ADD                 Point BX to the TOS user variable.
BX UP #) MOV              Copy this address into UP as the user pointer for the next task.
AX POP AX POP             Discard two items from the stack. They were pushed on the stack by the interrupt
                           routine waking up this task.
0 [BX] SP MOV             Restore the data stack pointer.
RP POP                    Restore the return stack pointer.
IP POP                    Restore the interpretive pointer.
NEXT                      IP contains the pointer pointing to the next word to be executed in this task.
                           NEXT will continue the execution left off last time.
END-CODE

CODE PAUSE                 A dummy word allowing multitasker to be switch on and off.
NEXT                      In the single user mode, PAUSE returns immediately without doing anything.
                           However, its code field will be patched so that the word. (PAUSE) will be invoked
                           in the multitasking mode of operation.
END-CODE

```

A few more commands are defined to manipulate data stored in the user area to control the tasks:

```

HEX 80 CONSTANT INT#      8086 software interrupt number, used to wake up a task.

```

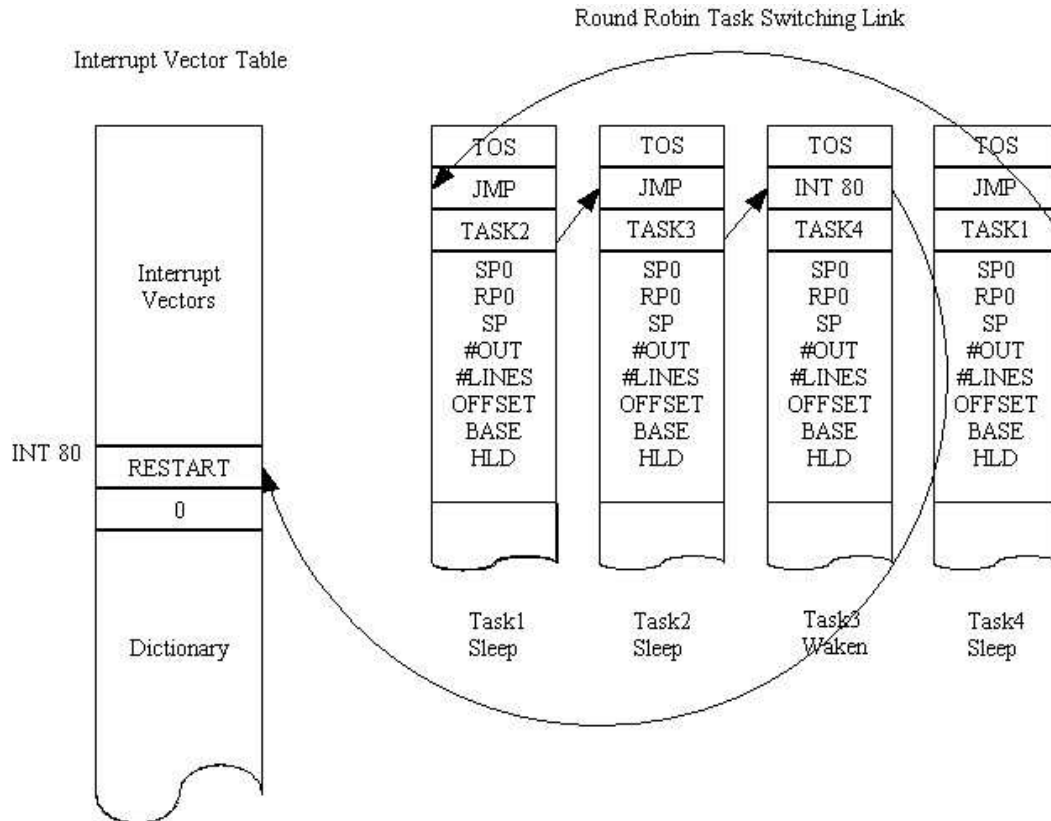

Figure 23.1 The round-robin task scheduler.

```

: LOCAL          ( base addr -- addr1 )
                  Get the address of a user variable in another task's user area.
UP @             The origin of current user area.
-               Offset of current user variable from its origin.
+               Add offset to the origin of the other user area (base), returning the address
;               of the same user variable in the other task.

: @LINK ( -- addr ) Return a pointer to the entry point in the next task.
LINK           Address of LINK in this task.
DUP @ +        Get the ENTRY in the next task.
2+            LINK field in the next task.
;

: !LINK ( addr -- ) Set the LINK field of the current task, given the origin of the user area of the
LINK -         next task.
                The relative distance from LINK to the other task.
2+            Relative distance from this LINK to the other LINK.
LINK !        Store it in the current LINK.
;

: SLEEP ( addr -- ) Make the addressed task pause indefinitely.
E990          90 is NOP and E9 is JMP in 8086 machine instruction. JMP (link) passes CPU to
              the next task whose address is in the LINK field right after the ENTRY field.
              Get the task address to top.
SWAP          Get the address of the ENTRY field in the target task.
ENTRY LOCAL   Store the sleep code in its ENTRY field and force that task to pass control
!             immediately to its next task.
;

: WAKE ( addr -- ) Wake up a task so that it will execute in its next turn.
80CD          Machine instruction INT 80H which wakes up this task by a software interrupt with
              vector number 80H.
SWAP          Get the task's user area address.
ENTRY LOCAL ! Store that wake code in the ENTRY field of the target task and make it an active

```

```

;
; member in the round-robin loop.
;
: STOP ( -- )      Make the current task pause indefinitely.
UP @              Get the address of the current task.
SLEEP            Put it to sleep.
PAUSE           Stop right now.
;

```

23.4. The Multitasker

The Forth multitasker is implemented using a round-robin scheduler and dispatcher technique. All tasks are linked into a loop. A task must use the PAUSE command explicitly to relinquish CPU control to the next task. If a task does not need the CPU service, it will pass the CPU control directly to the next task. When a task needs CPU, it will put a wakeup code in the ENTRY field in its user area. Next time when the control of CPU is passed to it, it will be able to grab the CPU and restart or continue on the execution left off last time. Each task therefore must include PAUSEs at suitable intervals to let other tasks have a piece of the action. Otherwise a task can hold onto the CPU indefinitely and no other task can use the CPU. The cooperative nature of this scheme thus requires that each task be designed to pause regularly. The advantage is that each task can stop and restart at known points and the commands to do the multitasking are simple and fast.

```

CODE MULTI ( -- )      Install the multitasker's schedule/ dispatcher loop by patching the appropriate
; interrupt vector and enabling PAUSE.
; ' (PAUSE) @ # BX MOV  Copy the contents of code field of (PAUSE) to BX register. It is the starting
; address of the (PAUSE) code routine.
BX ' PAUSE #) MOV      Patch the code field of PAUSE with code of (PAUSE) so that the task will pause
; at PAUSE.
; ' RESTART @ # BX MOV  Get the RESTART code address.
DS AX MOV             Save DS register on data stack.
AX PUSH
AX AX SUB             Clear AX register.
AX DS MOV             Clear DS register.
CS AX MOV             Copy code segment into AX.
AX INT# 4 * 2+ #) MOV  Store the code segment in the second cell of the interrupt vector for this task.
BX INT# 4 * #) MOV    Store the RESTART address in the first cell of the interrupt vector. Hereafter,
; INT 80H will activate this task
;
AX POP
AX DS MOV             Restore the data segment register.
NEXT
END-CODE
;
: SINGLE ( -- )      Remove the multitasker's scheduler/dispatcher loop.
['] PAUSE >BODY      Get the parameter field address of PAUSE, which points to a simple NEXT routine.
['] PAUSE !          Restore the code field of PAUSE so that PAUSE will return immediately rather
;                    than go through (PAUSE) for the multitasker.
;

```

23.5. Task Definition

A task must be first defined as a command in the dictionary. At the same time, user area and space for two stacks must also be allocated for this task. The new task must then be installed in the round-robin loop. When functions must be performed by this task, a command to be executed by this task must be passed to it and the task must be waken. The tools to create and activate new

tasks are discussed in this section.

```

: TASK: ( size -- )      Create a new named task and initialize its user variables.
CREATE                  Build an header for the task.
TOS                    Address of the user area for the current task.
HERE                   The user area of the new task.
#USER @                Size of the user area.
CMOVE                  Copy the current user variables into the new user area for the new task.
@LINK                  New user area.
UP @ -ROT              Save the current user area pointer at the bottom of the data stack.
HERE UP !              Put new user area address in the user area pointer UP.
!LINK                  Store address of current user area in the LINK field of the new task.
DUP HERE +             Address of the space after the new user area and dictionary space.
DUP RP0 !              Initialize the return stack pointer of the new task.
100 - SP0 !            Initialize the data stack pointer of the new task.
SWAP UP !              Restore the user area pointer to the current user area.
HERE ENTRY LOCAL !LINK Store the address of the new task in the LINK field of the current task.
HERE #USER @ +         Starting address of the dictionary for the new task.
HERE DP LOCAL !        Initialize the dictionary pointer of the new task.
HERE SLEEP             Put the new task to sleep first.
ALLOT                  Allocate space for the new task according to the size parameter given on the stack
initially.
;

: SET-TASK              ( ip task -- )
Assign an existing task to execute the code pointed to by ip on stack.
DUP SP0 LOCAL @        Get the top of data stack of the task to be used.
2-                      Decrement stack pointer preparing a push.
ROT OVER !              Push ip on data stack.
2-                      Prepare another push.
OVER RP0 LOCAL @        Get the new tasks return stack pointer.
OVER !                  Push it on the data stack.
SWAP TOS LOCAL !        Store the data stack pointer in the TOS field of the new task. These actions
simulate (PAUSE) in a way that when the new task is waken the code pointed to
by ip will be executed.
;

: ACTIVATE ( task -- ) Assign the invoked task to execute the following code, and wake the task making
it ready to execute these code.
R>                      Address of the next code to be executed.
OVER SET-TASK           Assign this code to the task.
WAKE                    wake the task.
;

```

23.6. Background Tasks

A background task is some functions the computer does in the background, while still allowing you to use the computer interactively doing programming or execute other programs. F83 allows you to create many of such tasks to run concurrently, using the task defining and control commands. Here are some examples illustrating the command sequence to create background tasks and activate them.

```

: BACKGROUND: ( -- )    Create a new task with 400 bytes of dictionary space. Initialize this task to
execute the following code.
400 TASK:              Define a new task with the name following.
HERE                   IP for code to be compiled so that it can be executed by the new task.
@LINK 2-               Address of the new task.
SET-TASK               Initialize the new task.
!CSP                   Compiler error checking initial- ization.
]                       Turn on the compiler to compile following code to be executed by the new task.
;

BACKGROUND: SPOOLER    ( -- ) Create a new task named spooler which will print the current file.
1                       First screen to be listed.
CAPACITY               Last screen in the current file.
SHOW                   List the entire file.

```

```
STOP                Stop the task here. STOP is needed at the end of a task.
;
```

Executing SPOOLER will print out the entire current file on the printer while you can still use the terminal for normal activities. Low level input/output commands in SHOW contain enough PAUSE commands to alternate the spooling task with the terminal task to allow you seemingly full control over the computer while it is also printing a long file. SPOOLER can also be assigned a different function by the following command:

```
: SPOOL-THIS ( -- )    Assign new functions to an existing task.
SPOOLER ACTIVATE      Force the task SPOOLER to execute the following code:
3 15
[ SHADOW ] SHOW       Invoke the special SHOW command in the SHADOW vocabulary to print shadow screens
                        along the source screens.
STOP                  Terminate the task.
;
```

Another example is to use the computer to keep a counter which keeps the number of circles the multitasker running around the round-robin loop:

```
VARIABLE COUNTS

BACKGROUND: COUNTER   Define a new background task.
BEGIN                 Beginning of an infinite loop.
  PAUSE               Allow other tasks to run once.
  1 COUNTS +!         Increment the counter.
AGAIN                 ;
```

The task COUNTER executes an infinite loop, so STOP is not required at the end of the command. However, note that you must use PAUSE in the loop, or no other task will be executed. PAUSE is built in all the input/output commands, so that tasks which do I/O like SPOOLER do not have to use PAUSE explicitly.

Chapter 24. 8086 Assembler

The source code of the assembler is in CPU8086.BLK, Screen 3 to 17, and KERNEL86.BLK, screen 80.

The assembler in Forth allows you to define commands which will be executed at the raw machine speed and make use of all the resource in the host computer hardware system. It is often used to optimize a system or application program by recoding the critical or most often executed commands to improve the performance of the program. A high level command can be substituted by a machine code command if the interface to the system, most notably the stack effect is kept the same.

The assembler is invoked by the defining command `CODE` which creates a header in the dictionary and makes the code field pointing to the parameter field. Machine instructions can then be assembled into the parameter field by a set of machine code commands with mnemonic names similar to those used in regular assembler of the host processor. These machine code commands are executed by the text interpreter and the net effect is to add new machine instructions to the parameter field so that when the new `CODE` command is executed, these machine instructions are executed in sequence. A `CODE` command must be terminated by the inner interpreter `NEXT` or its derivative to return control to the calling command. The code command must be terminated with a command like `END-CODE` or `C;`, which makes the new command available for execution or compilation.

24.1. Assembly Tools

A set of tool commands are needed to assemble a machine code command in its most primitive form. If you know the host processor well enough, you can hand code a routine and generate a Forth `CODE` command without using the assembler.

```
VARIABLE AVOC           A variable holding the old context vocabulary during assembling.

: CODE ( -- )          The defining word that starts the assembling process to build a machine code word.
  CREATE              Create the name field, link field, and code field for a new entry in the dictionary.
  HIDE                Smudge the header to hide the new word before it is completed.
  HERE DUP 2- !       Store the pfa into code field. This is required for indirectly threaded code.
  CONTEXT @ AVOC !    Save the old context vocabulary.
  ASSEMBLER           Use the ASSEMBLER as the context vocabulary to assemble machine code.
;

: LABEL ( -- )         Mark the start of a subroutine. Return its address when the label is invoked.
  CREATE              Create the header.
  ASSEMBLER           Select context vocabulary.
;

232 CONSTANT DOES-OP   Op-code for CALL instruction used in DOES>.
3 CONSTANT DOES-SIZE   A CALL instruction consumes 3 bytes.
```

```

: DOES? ( ip -- ip+3 f ) Return a true flag with the IP moved over the CALL instruction.
DUP DOES-SIZE +         IP incremented by DOES-SIZE.
SWAP C@                 Code at IP.
DOES-OP =                True if the opcode is CALL.
;

ASSEMBLER DEFINITIONS All the assembler tool words are to be collected in this vocabulary.

: END-CODE ( -- )       Terminate a code definition, make it available and also restore context
                        vocabulary.
AVOC @ CONTEXT !       Restore the old context vocabulary.
REVEAL                  Unsmudge the header, making the word available to the text interpreter.
;

: C; ( -- )             Synonym for END-CODE.
END-CODE
;

```

The following set of deferred commands are used in assembling machine instructions or constructing structures in the code commands. They are defined as deferred commands so that they can be shared by the assembler and the metacompiler.

```

DEFER C, ( byte -- )    Assemble a machine code byte to the dictionary.
FORTH ' C, ASSEMBLER IS C, Vector it to the FORTH C, .
DEFER , ( n -- )       Assemble a cell to the dictionary.
FORTH ' , ASSEMBLER IS , Vector to the FORTH , (comma).

```

C, and , are the primitive Forth assembler. Using them alone, you can generate code commands without using an assembler. However, the machine instructions and operands have to be hand coded and stored into the dictionary by , and C, .

```

DEFER HERE ( -- addr ) Return a pointer to the top of dictionary, the address of the next code
                        to be assembled.

FORTH ' HERE ASSEMBLER IS HERE

DEFER ?>MARK           Set up forward branch with error checking.
DEFER ?>RESOLVE        Resolve a forward branch with error checking.
DEFER ?<MARK           Set up a backward branch with error checking.
DEFER ?<RESOLVE        Resolve a backward branch with error checking.

```

24.2. 8086 Register Definitions

Registers are used as operands, which are inserted into the register field in a machine instruction. They are thus defined as constants. The register constants are defined in the following format to facilitate the building of machine instructions which uses the corresponding register, as shown in Fig. 24.1. The lower byte may become a byte instruction or the second instruction byte to specify addressing mode. The upper byte with the mode field is used only during assembly.

Addressing Mode Word

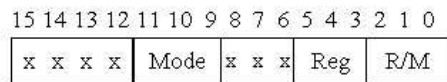

Register Modes and Mnemonics

Register	Mode				
	0	1	2	3	4
0	AL	AX	[BX+SI]	ES	# Immediate
1	CL	CX	[BX+DI]	CS	#) Indirect
2	DL	DX	[BP+SI]	SS	S#) Intersegment
3	BL	BX	[BP+DI]	DS	
4	AH	SP	[SI]		
5	CH	BP	[DI]		
6	DH	SI	[BP]		
7	BH	DI	[BX]		

Figure 24.1 Register addressing mode constant.

```
OCTAL                8086 codes are best represented in octal due to the 3 bit fields.

: REG ( mode reg# -- ) Use the addressing mode and the register number to generate the proper register
                        field to be defined as register constants.
11 * SWAP             Fill both reg and r/m fields.
1000 * OR             The addressing mode field.
CONSTANT             Defined as a constant to be inserted into register accessing code.
;

: REGS ( n mode -- )  Define a set of register words which differ only in the register number.
SWAP 0 DO            Scan through n registers.
  DUP I REG          Define each register as a constant.
LOOP
.DROP                Discard mode
.;
```

Using the powerful REGS, we can define all the registers with all possible addressing modes as distinct Forth commands. They return the appropriate register constants to be used by machine code assembler commands to construct machine instructions.

```
10 0 REGS             Define operands addressing only bytes in the registers.
AL CL DL BL AH CH DH BH

10 1 REGS             Define operands addressing word registers.
AX CX DX BX SP BP SI DI

10 2 REGS             Define indexed addressing operands.
[BX+SI] [BX+DI] [BP+SI]
[BP+DI] [SI] [DI] [BP] [BX]

4 2 REGS              Duplicated definitions.
[SI+BX] [DI+BX] [SI+BP]
```

```

[DI+BP]

4 3 REGS          Segment register addressing operands.
ES CS SS DS

3 4 REGS          Immediate addressing operands.
# #) S#)

```

Four registers are of special interests to the Forth system because they are used as registers in the Virtual Forth Computer. They are assigned generic names more appropriate in the manipulation of the Forth machine:

```

BP CONSTANT RP          The return stack pointer.
[BP] CONSTANT [RP]     Indirect addressing mode.
SI CONSTANT IP          The interpretive pointer.
[SI] CONSTANT [IP]
BX CONSTANT W           The current word pointer.
[BX] CONSTANT [W]

```

The data stack pointer uses the SP register which already has the correct name; therefore, it does not need a new name.

24.3. Addressing Mode Operators

```

: MD ( mode -- )          Define words which will test various addressing modes.
  CREATE                  Make header.
  1000 * ,                 Compile a template of addressing mode.
  DOES>                    ( mode-field -- f )
  .@                        Get the template
  .SWAP 7000 AND           Mask over the mode field
  .= 0<>                   Return true if the mode matches
  .;

0 MD R8? ( operand -- f ) Is it in byte register mode?
1 MD R16? ( operand -- f ) Is it in word register mode?
2 MD MEM? ( operand -- f ) Is it in memory addressing mode?
3 MD SEG? ( operand -- f ) Is it in segment addressing mode?
4 MD #? ( operand -- f )  Is it in immediate addressing mode?

: REG? ( operand -- f )   Test for either byte or word addressing mode.
  7000 AND                Mask the mode field.
  2000 <                  Byte or cell.
  < 0<>                   Return the flag.
  ;

: BIG? ( n -- f )        Test the size of address offset. Return true if n>255.
  ABS                      Absolute offset.
  -200 AND                 Examine upper byte.
  0<>                      True if not zero.
  ;

: RLOW ( n1 -- n2 )      Retain only the low r/m field.
  7 AND                    ;

: RMID ( n1 -- n2 )      Retain only the middle register field.
  70 AND                   ;

VARIABLE SIZE             A flag. True for 16 bit and false for 8 bit number.

: BYTE ( -- )            Reset SIZE to indicate byte operations.
  SIZE OFF                 ;

: OP, ( n opcode -- )    OR the operand and the opcode and assemble the machine code.
  OR C,                    ;

: W, ( opcode operand -- ) Assemble opcode with the W field set if operand indicates a word register.

```

```

R16? 1 AND          Set W field according to word mode.
OP,                 Assemble.
;

: SIZE, ( opcode -- ) Assemble the opcode with W field determined by SIZE.
SIZE @ 1 AND       Set W field using SIZE.
OP,                 Assemble.
;

: ,/C, ( n f -- )   Assemble a cell if f is true. Otherwise assemble a byte.
IF ,               f is true. Assemble a cell.
ELSE C,            f is false. Assemble a byte.
THEN ;

: RR, ( operand1 operand2 -- ) Assemble a register to register instruction.
RMID               Operand1 to r/m field.
SWAP RLOW          Operand2 to reg field.
OR                 Register to register operand.
300                Register to register mode.
OP,                 Assemble the reg-reg second instruction byte for addressing.
;

VARIABLE LOGICAL   True while assembling logical instructions.

: B/L? ( n -- f )   BIG? of LOGICAL.
BIG? LOGICAL @ OR
;

: MEM, ( disp mr rmid -- ) Assemble a memory reference instruction. It takes a displacement, and
memory/ register, and a register a arguments and encode them into an
instruction.
OVER #) =          Is it in immediate indirect mode?
IF                 Yes.
  RMID 6 OP,        Assemble immediate indirect instruction.
  DROP              No need of mr now.
  ,                 Assemble disp, which is the immediate value.
ELSE               Not immediate indirect.
  RMID OVER RLOW OR OR together the registers.
  -ROT              Save it.
  [BP] =            mr=[BP]?
  OVER 0= AND       AND disp=0?
  IF
    SWAP            Get the register field to top.
    100 OP,         Byte displacement mode instruction. Mode 1.
    C,              With the byte displacement.
  ELSE
    SWAP            Examine disp.
    OVER BIG?       More than 8 bits?
    IF              Yes.
      200 OP,       Mode 2 instruction.
      ,             With cell displacement.
    ELSE
      OVER 0=       Is disp=0?
      IF            Yes.
        C,           Assemble byte instruction.
        DROP         No displacement.
      ELSE          All tests failed to reach here.
        100 OP,     Assemble mode 1 instruction anyway.
        C,           Append a byte displacement.
      THEN
    THEN
  THEN
THEN
;

: WMEM, ( disp mem reg op -- ) Assemble a word memory reference instruction.
OVER W,            Pack the word referencing bit into reg and assemble opcode.
MEM,               Use MEM, to assemble the right mode instruction.
;

: R/M ( mr reg -- ) Assemble either a register to register or register to memory instruction.
OVER REG?         Is it in a register mode?
IF RR,             Yes. Assemble a register to register instruction.
ELSE MEM,          Else assemble a memory referencing instruction.
THEN
;

```

```

: WR/SM ( rm reg op -- )      Assemble either a register mode instruction with size field, or a memory
                                mode instruction with size from SIZE.
2 PICK                        Get the mode.
DUP REG?                      Is it register mode?
IF                             Yes.
  W,                          Squeeze in the word bit.
  RR,                          Assemble a register-register instruction.
ELSE                           Not register mode.
  DROP                        Discard mode.
  SIZE,                       Use SIZE for word bit.
  MEM,                        Assemble memory instruction.
THEN
SIZE ON                        Set default size to 16 bits.
;

VARIABLE INTER                True if doing inter-segment jump, call, or return.

: FAR ( -- )                  Set INTER true.
  FAR ON ;

: ?FAR ( n1 -- n2 )          If INTER is true, set the far bit in the instruction.
  INTER @                     If INTER is true,
  IF 10 OR THEN              set bit 3 in the instruction.
  INTER OFF                  Reset far flag.
;

```

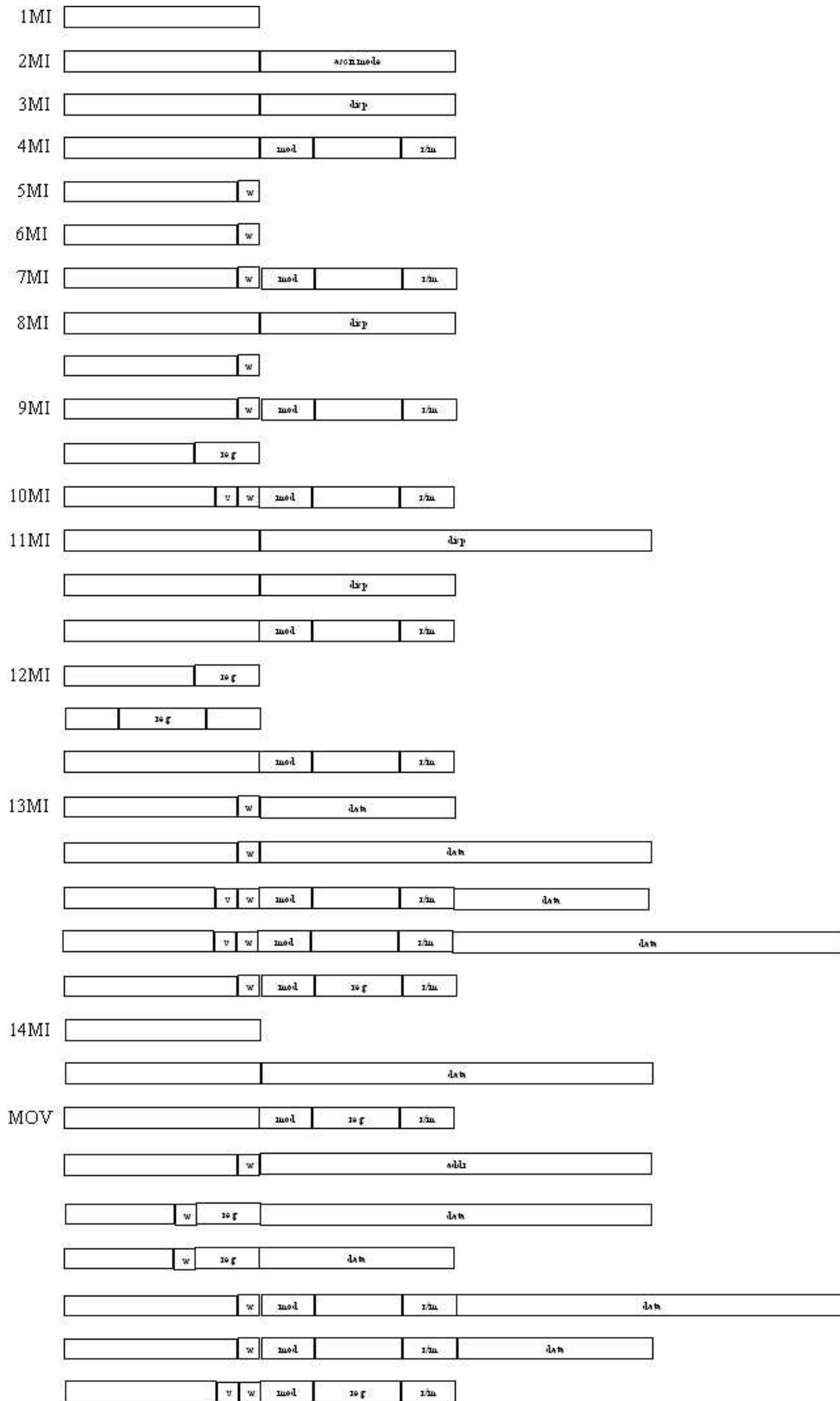

Figure 24.2 8086 instruction types.

24.4. Defining Commands To Generate Opcodes

8086 is a rather complicated microprocessor. It was designed to be 8080 downward compatible so that it must be able to execute all the 8080 instructions. With lots of 16 bit machine instructions and operators for the extra registers and different mode of operation, the instruction set becomes very big. Consequently, the assembler also becomes complicated in order to take care of these diverse types of instructions. There are 14 identifiable classes of instructions in 8086. A defining command is used to generate opcodes for each class of instructions

```
: 1MI ( opcode -- )      Define one byte constant instructions.
CREATE C,                Create header and compile the opcode.
DOES>                    ( -- )
C@                        Fetch opcode from the parameter field of the assembler word.
C,                        Assemble it.
;
```

```
HEX
37 1MI AAA      3F 1MI AAS      98 1MI CBW      F8 1MI CLC
FC 1MI CLD      FA 1MI CLI      F5 1MI CMC      99 1MI CWD
27 1MI DAA      2F 1MI DAS      F4 1MI HLT      CE 1MI INTO
CF 1MI IRET     9F 1MI LAHF     F0 1MI LOCK     90 1MI NOP
9D 1MI POPF     9C 1MI PUSHF     F2 1MI REP      F2 1MI REPZ
9E 1MI SAHF     F9 1MI STC      FD 1MI STD      FB 1MI STI
9B 1MI WAIT     D7 1MI XLAT
OCTAL
```

```
: 2MI ( opcode -- )      Define ASCII instructions.
CREATE C,                Header and parameter field.
DOES>                    ( -- )
C@ C,                    Assemble the opcode.
12 C,                    Assemble the ASCII mode byte.
;
```

```
HEX D5 2MI AAD D4 2MI AAM OCTAL
```

```
: 3MI ( opcode -- )      Define branch instructions with one byte offset.
CREATE C,
DOES>                    ( addr -- )
C@ C,                    Assemble opcode.
HERE - 1-                Offset from current address.
C,                        Assemble the offset.
;
```

```
HEX
77 3MI JA      73 3MI JAE      72 3MI JB      76 3MI JBE
E3 3MI JCXZ    74 3MI JE      7F 3MI JG      7D 3MI JGE
7C 3MI JL      7E 3MI JLE     75 3MI JNE     71 3MI JNO
79 3MI JNS     70 3MI JO      7A 3MI JPE     7B 3MI JPO
78 3MI JS      E2 3MI LOOP    E1 3MI LOOPE   E0 3MI LOOPNE
OCTAL
```

```
: 4MI ( opcode -- )      Define LDS, LEA, LES instructions.
CREATE C,
DOES>                    ( disp mr rmid -- )
C@ C,                    Assemble opcode.
MEM,                    Memory reference.
;
```

```
HEX C5 4MI LDS 8D 4MI LEA C4 4MI LES OCTAL
```

```
: 5MI ( opcode -- )      Define string instructions.
CREATE C,                Store opcode.
DOES>                    ( -- )
C@ SIZE,                Assemble opcode with size bit.
SIZE ON                Enable word addressing.
;
```



```

HEX  A6 5MI CMPS  A4 5MI MOVS  AE 5MI SCAS  OCTAL

: 6MI ( opcode -- )      Define string instructions where byte/word mode is determined at assembly time.
CREATE C,                Store opcode.
DOES>                    ( mr -- )
C@                        Opcode.
SWAP W,                  Use mr to decide the word bit and assemble accordingly.
;

HEX  AD 6MI LODS  AA 6MI STOS  OCTAL

: 7MI ( opcode -- )      Define multiply and divide instructions.
CREATE C,                Store opcode.
DOES>                    ( r/m -- )
C@                        The opcode will be put in the reg field of the second byte.
366                      The real first byte opcode.
WR/SM,                   Assemble the whole mess.
;

HEX  30 7MI DIV  38 7MI IDIV  28 7MI IMUL  20 7MI MUL
.10 7MI NOT  OCTAL

: 8MI ( opcode -- )      Define input/output instructions.
CREATE C,                Opcode.
DOES>                    ( port -- )
C@                        Opcode.
OVER R16?                Is the port# a 16 bit number?
1 AND OR                 OR the word bit to opcode.
OVER # =                 Is there an immediate operator?
IF                        Yes, a port# is given.
C,                        Assemble opcode.
C,                        Assemble port number.
ELSE                      Implied port.
10 OR                    Set the implied port bit in opcode.
C,                        Assemble one byte i/o instruction.
THEN
;

HEX  E4 8MI IN  E6 8MI OUT  OCTAL

: 9MI ( opcode -- )      Define increment/decrement instructions.
CREATE C,                Store opcode.
DOES>                    ( reg -- )
C@                        Get opcode first.
OVER R16?                Mode 1 operation?
IF                        Yes.
100 OR                   Opcode for one byte inc/dcr instruction.
SWAP RLOW                Retain only r/m field.
OP,                       Assemble one byte instruction.
ELSE                      Other modes.
376                      First byte opcode.
WR/SM,                   Use stored opcode as second byte instruction.
THEN
;

HEX  08 9MI DEC  00 9MI INC  OCTAL

: 10MI (opcode -- )      Define Shift/rotate instructions.
CREATE C,                Store opcode.
DOES>                    ( reg -- , or reg CL -- )
C@                        Stored opcode.
OVER CL =                Top register is CL?
IF                        Multiple bit shift.
NIP                       Discard CL because it is implied.
322                      Number of bits shifted in CL.
ELSE                      Single bit shift.
320
THEN
WR/SM,                   Assemble the two-byte instruction.
;

HEX  10 10MI RCL  18 10MI RCR  00 10MI ROL  8 10MI ROR
.38 10MI SAR  20 10MI SHL  28 10MI SHR  OCTAL

```

```

: 11MI          ( opcode1 opcode2 -- ) Define call/jump instructions.
CREATE          Header.
C,              Indirect call/jmp opcode.
C,              Direct call/jmp opcode.
DOES>          ( addr -- )
OVER #) =      Immediate address?
IF              Yes.
  NIP           Discard #) mode operator.
  C@            Get the opcode.
  INTER @ IF   If it is intersegment addressing,
  1 AND        and a jump?
  IF 352       Yes. Jump opcode.
  ELSE 232 THEN No. Call opcode.
  C,           Compile jmp/call opcode.
  SWAP , ,     Compile offset and segment.
ELSE           Not intersegment addressing.
  SWAP         Target address addr.
  HERE - 2-    Displacement.
  SWAP         ( disp opcode -- )
  2DUP 1 AND   Is it JMP?
  SWAP BIG? NOT AND And disp<256?
  IF           If so, assemble short jump.
  2 OP,        Short jump opcode.
  C,           Byte displacement.
ELSE           Long jump or call.
  C,           Opcode.
  1-          Offset for three-byte instruction.
  ,           Long displacement.
  THEN
THEN
ELSE           Not immediate addressing.
DUP S#) =      Is it intrasegment addressing?
IF DROP #) THEN Yes. Restore the immediate address code.
377 C,         Assemble opcode.
1+ C@          Get the initial r/m mode code.
?FAR          Add the intersegment far bit if necessary.
R/M           Append it to the opcode.
THEN
;

```

```
HEX 10 EB 11MI CALL 20 E9 11MI JMP OCTAL
```

```

: 12MI          ( reg-op seg-op r/m-op -- ) Define push and pop instructions.
CREATE          Header.
C, C, C,       Store three different opcodes for push or pop.
DOES>          ( reg -- )
OVER REG?      Register mode?
IF             Yes.
  C@            Register mode opcode.
  SWAP RLOW OP, Assemble it.
ELSE
  1+           Point to the second opcode.
  OVER SEG?    Segment register mode?
  IF           Yes.
  C@            Get segment opcode.
  RLOW         Save only r/m field.
  SWAP RMID    Put in the reg field.
  OP,          Assemble.
ELSE
  COUNT        Get second opcode and point to the third opcode.
  SWAP C@      Get the third opcode.
  C,           Assemble the third opcode as the first byte of instruction.
  MEM,         Assemble the addressing mode, second byte of instruction.
  THEN
THEN
;

```

```
HEX 8F 07 58 12MI POP FF 36 50 12MI PUSH OCTAL
```

```

: 13MI ( op1 op2 -- ) Define arithmetic and logic instructions.
CREATE          Make header.
C, C,          Store opcodes.
DOES>          ( operand1 operand2 -- )
COUNT >R     Fetch and store opcode1.
C@ LOGICAL !   Save opcode2 in LOGICAL.
DUP REG?       Is operand2 a register?

```

```

IF                                Yes.
OVER REG?                         Is operand1 also a register?
IF                                 Yes. A reg-reg math/logic operation.
  R>                               Get opcode1.
  OVER W,                          Assemble opcode1 with w field.
  SWAP RR,                         Assemble addressing byte.
ELSE                                Operand1 is not a register.
  OVER DUP MEM?                    Memory referece?
  SWAP #) = OR                     Or memory indirect?
  IF                                Yes.
  R> 2 OR                           Assemble opcode1 with direction field.
  WMEM,                            Memory referece.
ELSE                                Not memory referencing.
  NIP                               Discard operand1.
  DUP RLOW 0=                       Is operand2 the accumulator?
  IF                                Yes.
  R> 4 OR                           One byte math instruction. Fill the math field (bit 2).
  OVER W,                          Fill in the w field.
  R16? ,/C,                        Assemble the byte or word immediate value.
ELSE                                Operand2 is not the accumulator.
  OVER B/L?                         Big and long?
  OVER R16?                         Operand2 a 16 bit register?
  2DUP AND                          True for 16 bit logic instruction.
  -ROT                              Save the flag.
  1 AND                              W field.
  SWAP                              16 bit-logic flag.
  NOT 2 AND                         Sign extension field.
  OR                                 Combine s and w fields.
  200 OP,                           Assemble first byte opcode.
  SWAP RLOW                          r/m field.
  300 OR                             Mode 3.
  R> OP,                             Second byte mode instruction.
  ,/C,                               Third byte or word value.
  THEN
  THEN
ELSE                                Operand2 is not a register.
ROT DUP REG?                       Is operand1 a register?
IF R> WMEM,                         Yes. Assemble memory referencing math instruction.
ELSE                                Not memory referencing. Must be immediate value.
  DROP                              It is not a register. Discard it because it is a memory code.
  2 PICK                             Pick the displacement.
  B/L?                               Larger than 255?
  DUP NOT 2 AND                      Fill in the s field.
  200 OR SIZE,                      Assemble first instruction with w field.
  -ROT                              Save the BIG? flag.
  R> MEM,                           Assemble the mode byte.
  SIZE @                             Must be BIG and word size.
  AND ,/C,                          Assemble the immedate value.
  SIZE ON                            Reinitialize SIZE to 16 bit.
  THEN
  THEN
;

HEX  0 10 13MI ADC   0 00 13MI ADD   2 20 13MI AND
      0 38 13MI CMP   2 08 13MI OR    0 18 13MI SBB
      0 28 13MI SUB   2 30 13MI XOR   OCTAL

: 14MI ( -- )          Returns.
CREATE C,              Compile the opcode.
DOES>
C@                    Get opcode.
DUP ?FAR              Add the intersegment bit if necessary.
C,                   Assembler opcode.
1 AND 0=              If it has immediate offset,
IF , THEN            Assemble the address offset.
;

HEX  C3 14MI RET   C2 14MI +RET   OCTAL

```

24.5. Special Opcodes

A small number of instructions do not belong to any of the above types. They are defined

individually as colon commands which have to do special assembly work to assemble their respective machine instructions.

```

HEX

: ESC                ( source opcode -- )
                    Escape to external device.
RLOW                Retain only the low register field.
0DB OP,            Assemble the ESC opcode.
R/M,               With the r/m code.
;

: INT ( n -- )      Assemble an interrupt instruction.
0CD C,            INT, interrupt instruction.
C,                n, the interrupt vector number.
;

: SEG ( seg -- )    Assemble a segment instruction.
RMID              Mask over the segment field.
26 OP,            Opcode for segment instruction.
;

: XCHG ( mr1 mr2 -- ) Assemble register exchange instruction.
DUP REG?          mr2 a register?
IF DUP AX =       And the AX register?
IF                mr2=AX.
DROP              AX is implied.
RLOW 90 OP,       Assemble opcode 90 with m1.
ELSE              m2 is not AX.
OVER AX =         Is m1 AX?
IF                m1=AX.
NIP              No need of m1 anymore.
RLOW 90 OP,       Assemble XCHG with m2.
ELSE              Neither is AX.
86 WR/SM,        Assemble XCHG with a mode byte.
THEN
THEN
ELSE              mr2 is not a register.
ROT 86 WR/SM,    Assemble XCHG with mode byte.
THEN
;

: CS: CS SEG ;     Code segment override.
: DS: DS SEG ;     Data segment override.
: ES: ES SEG ;     Extra segment override.
: SS: SS SEG ;     Stack segment override.

: MOV ( source dest -- ) Assemble a MOV instruction, the most complicated instruction in 8086.
DUP SEG?          Is dest a segment register?
IF 8E C,          Assemble segment MOV,
R/M,              and the mode byte with source.
ELSE DIP REG?     Is dest a register?
IF                Dest is a register.
OVER #) =         Source is from memory?
OVER RLOW 0= AND  And dest is AX?
IF A0 SWAP W,     Yes. Assemble mem to AX MOV,
DROP              discard dest, and
,                 assemble memory address.
ELSE OVER SEG?    Is source a segment register?
IF                Yes.
SWAP 8C C,        Assemble segment to r/m MOV,
RR,               with the mode byte.
ELSE              Source and dest are not segment register.
OVER # =          Immediate source?
IF NIP            Yes. Discard # code.
DUP
R16?              Is dest 16 bit?
SWAP
RLOW              reg field of dest.
OVER 8 AND OR     Combine reg field and w field.
B0 OP,            Assemble immediate to reg MOV,
/C,               with the immediate value.
ELSE              Not immediate source.

```

```

        8AOVER W,          Assemble segment to r/m MOV,
        R/M,              with a mode byte.
        THEN
    THEN
ELSE
    ROT DUP SEG?         Dest is not a register. Treat it as memory reference.
    IF 8C C,             Is source a segment register?
        MEM,             Yes. Assemble segment to memory MOV,
    ELSE DUP # =         with memory reference mode byte.
        IF DROP          Immediate source?
            C6 SIZE,     Yes. Discard immediate code.
            0 MEM,       Assemble immediate to reg/mem MOV,
            SIZE @ ,/C,  with a mode byte having 0 reg field,
        ELSE OVER #) =   and the immediate value.
            OVER RLOW 0= AND s dest a memory reference?
            IF A2 SWAP W, And the source is AX?
                DROP     Assemble AX to memory MOV.
                ,        Memory code #).
            ELSE        Memory address.
                88 OVER W, Non of above. Must be register to re/m MOV.
                R/M,     Assemble reg-r/m MOV instruction,
                THEN     with the mode byte.
            THEN
        THEN
    THEN
SIZE ON          Default size is 16 bit words.
;

: TEST          ( source dest -- )
                Assemble TEST instruction which AND source with dest and set the status register.
DUP REG?       Is destination a register?
IF OVER REG?   And is source also a register?
    IF         Both operands are registers.
        204 OVER W, Assemble opcode.
        SWAP RR, Assemble reg to reg mode byte.
    ELSE       Source is not a register.
        OVER DUP MEM? Is source a memory reference
        . SWAP #) = OR or an immediate address?
        IF 204 WMEM, Assemble memory to register code and mode byte.
        ELSE     Immediate data.
            NIP DUP
            RLOW 0= Is the source AL register?
            IF 250 Yes. Code for AL reg and immediate data mode.
                SWAP W, C, Assemble code and the immediate byte.
            ELSE Memory-immediate data mode.
                366 OVER W, Assemble code 366 with the word field.
                DUP RLOW 300 OP, Assemble immediate byte value.
                R16? ,/C, If 16 bit data, assemble high byte.
            THEN
        THEN
    THEN
ELSE           Destination is not a register.
    ROT UP REG? Is source a register?
    IF 204 WMEM, Yes. Assemble reg-mem TEST instruction.
    ELSE       Immediate value.
        DROP 366 SIZE, Immediate data and reg/mem mode.
        0 MEM, Memory reference.
        SIZE @ ,/C, If 2 bytes operand, assemble the second byte.
        SIZE ON Activate 16 word mode.
    THEN
    THEN
;

```

24.6. Structures in Code Commands

Structures similar to those in the regular colon commands can also be assembled in code commands. However, the structures in code commands are constructed using the branching and looping machine instructions. The test condition for branching is not a flag on top of the data stack but the

condition flags kept in the CPU status register.

Forward and backward branching are constructed using some commands similar to the MARK and RESOLVE in the colon compiler.

```
: A?>MARK ( -- f addr )      Set up a forward branch in code definition.
TRUE                          Leave a flag on stack for error checking.
HERE                           Address to branch from.
0 C,                           A dummy byte later to be resolved to a branching offset.
;

: A?>RESOLVE ( f addr -- )    Resolve a forward branching.
HERE OVER 1+ -                 Calculate the branching offset.
SWAP C!                        Store it after the branch instruction.
?CONDITION                     Abort if the flag is not true.
;

: A?<MARK ( -- f addr )      Set up a backward branch in code definition.
TRUE                           Set the flag.
HERE                           Leave current address on stack.
;

: A?<RESOLVE ( f addr -- )    Resolve a backward branch.
HERE 1+ -                      Backward branch offset.
C,                              Assemble the offset. Complete the branching instruction.
?CONDITION                     Abort if flag is not true.
;
```

The branching instructions are vectored through the commands >MARK, >RESOLVE, <MARK, and <RESOLVE. The execution routines vectored by these commands can now be resolved by pointing them to the above structure commands just defined in the assembler.

```
' A?>MARK ASSEMBLER IS ?>MARK
' A?>RESOLVE ASSEMBLER IS ?>RESOLVE
' A?<MARK ASSEMBLER IS ?<MARK
' A?<RESOLVE ASSEMBLER IS ?<RESOLVE
```

Conditionals in the assembler are machine codes to be assembled by the structure commands like IF, UNTIL, and WHILE. The conditionals are defined as constants to be assembled:

```
HEX
75 CONSTANT 0=      74 CONSTANT 0<>
79 CONSTANT 0<     78 CONSTANT 0>=
7D CONSTANT <      7C CONSTANT >=
7F CONSTANT <=     7E CONSTANT >
73 CONSTANT U< 72 CONSTANT U>=
77 CONSTANT U<=   78 CONSTANT U>
71 CONSTANT OV
DECIMAL

: IF ( opcode -- f addr )    Assemble a conditional branch instruction to start a forward branch.
C,                           Assemble conditional opcode.
?>MARK                       Set up forward branch.
;

: THEN ( f addr -- )        Close a conditional branch.
?>RESOLVE                    ;

: ELSE ( f1 addr1 -- f2 addr2 ) Resolve forward branch for IF and set up another forward branch to THEN.
0EB                          Unconditional branch opcode.
IF                             Assemble it here.
2SWAP THEN                   Resolve forward branch from IF.
;
```

```

: BEGIN ( -- f addr )      Set up a backward branch.
?<MARK                      ;

: UNTIL ( f addr opcode -- )  Resolve the backward branch to BEGIN.
OEB                          Unconditional branch.
UNTIL                          Let UNTIL do the resolving and assembling.
;

C,                             Assemble the conditional opcode.
?<RESOLVE                     Resolve the branch offset.
;

: AGAIN ( f addr opcode -- )  Resolve the backward branch with an unconditional branch instruction.

: WHILE ( -- f addr )        Forward branch.
IF                              ;

: REPEAT ( f1 addr1 f2 addr2 -- ) Branch back unconditionally.
2SWAP                          Get the BEGIN location.
AGAIN                          Assemble unconditional branch to BEGIN.
THEN                            Resolve WHILE clause.
;

: DO ( n -- addr )           Set up an assembler do-loop.
# CX MOV                        Assemble an instruction setting up the loop counter.
HERE                            Leave address for branch instructions.
;

: NEXT ( -- )                The inner interpreter.
>NEXT #) JMP                    Assemble an indirect jump.
;

```

DECIMAL

Chapter 25. Metacompiler

The source code discussed in this chapter is in the file META86.BLK and KERNEL86.BLK, Screen 1 to 10.

Metacompilation is a special feature of Forth to generate a new Forth system by an existing Forth system. It is impossible in other operating systems and languages because of the complexity in the conventional operating systems and language compilers. The most you can do in those environment is to do a 'sysgen', which allows a user to delete unnecessary or unused features in the full system and build a simpler system tailored to your application. The simplicity and conciseness of a Forth system give you much more freedom in selecting and eliminating features to suit your application. Metacompilation enables you to create a new system precisely customized to your needs, and the new system can be targeted to a different computer even with different CPU's.

25.1. Concept of Metacompilation

The theory behind Forth metacompilation is rather straightforward. Commands in the Forth dictionary can be compiled or assembled according to the specifications of the target machine. A new dictionary can be created for the target machine containing all the commands which are necessary for execution on the target machine. This new dictionary can then be transferred to the target machine and executed on the target machine. The new dictionary will, of course, contain the required nucleus to operate on the new host CPU with necessary interpreter, compiler, and applications. A special initialization routine must also be included to power up the new target system. The metacompilation is the process to generate the new dictionary for the target computer.

Currently F83 has been implemented on 8080, 8086/88, and 68000 microprocessors running under CP/M and MS-DOS operating systems. Metacompilation was used extensively to transport the F83 model to different CPU's and to different operating systems. The metacompiler used to create a F83 system is included in the F83 system so that you can use it to rebuild the system or to generate new systems suitable for your applications. The authors of F83 intended that you will modify their F83 systems to explore new uses of Forth and to develop commercial products for public utilization

Metacompilation is considered to be the highest level of extensibility in Forth. The first level of extensibility is to use predefined defining commands like `:` and `CODE` to add new commands to the

existing system. The second level of extensibility is to create new defining commands which can be used to compile new classes of commands or data structures to the dictionary, and to interpret them according to your specifications. The third level of extensibility, metacompilation, is to regenerate the entire Forth system with whatever extensions you might attach to it. This activity has been the privilege of large corporations and large teams or systems programmers at the expenses of billions of dollars, to build computer operating systems. In Forth, this privilege is accorded to us ordinary souls in the form of a metacompiler.

The most fundamental issue in metacompilation is that the target Forth system occupies an addressing space entirely different from the regular memory space the host Forth system addresses. The virtual address space of the target Forth system must be mapped to the real memory in the host Forth system. The metacompiler must be able to build the new system in the virtual memory space and resolve all the addresses and linkage accordingly. For one thing, the commands in the new system cannot be executed, and the new dictionary cannot be searched like normal Forth dictionary. Searching must be done through one or more symbol tables, and compiler directives must be defined in special vocabulary to help building structures in the commands belonging to the target system. These are non-trivial tasks.

25.2. Vocabularies for Metacompilation

The main purpose of metacompilation is to build new commands in the new target system using source code in the existing Forth system. It is thus necessary that a Forth command should execute differently depending upon when and where it is invoked. Multiple commands of the same name is a bad practice in normal Forth programming, but it is absolutely necessary in metacompilation. It is accomplished by using many vocabularies to house different commands of the same names. Any of these commands can be invoked by selecting a specific vocabulary searching order.

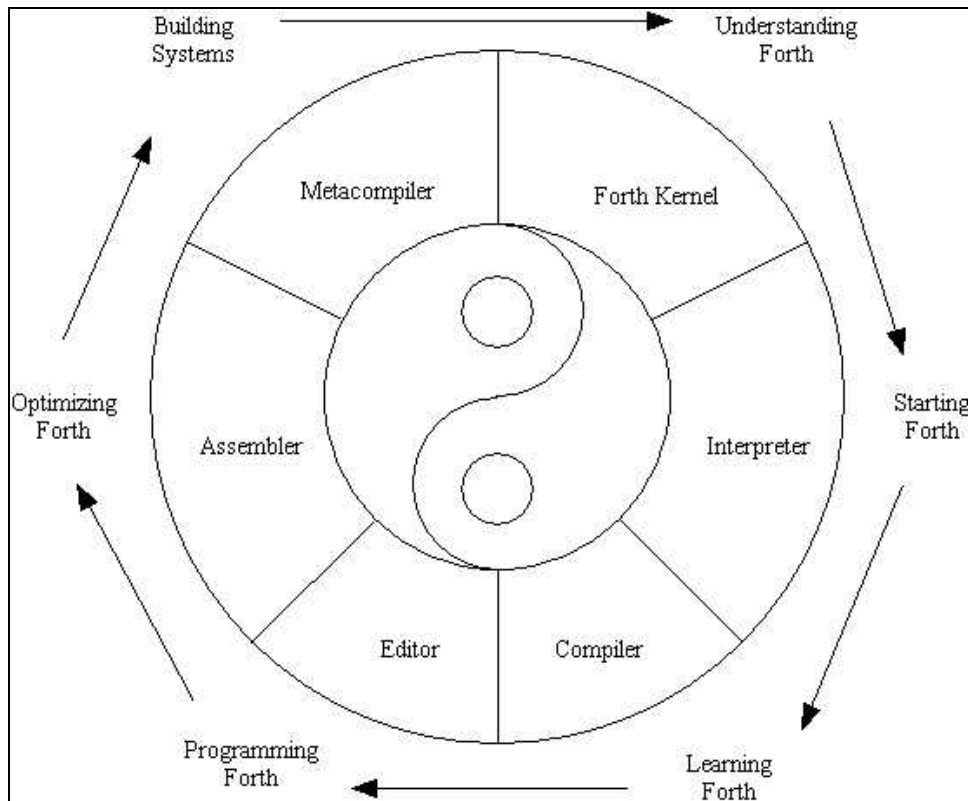

Figure 25.1 The chicken-egg cycle of meta-Forth

<pre> ONLY FORTH ALSO VOCABULARY META META ALSO META DEFINITIONS : [FORTH] FORTH ; IMMEDIATE : [META] META ; IMMEDIATE : SWITCH (--) NOOP NOOP DOES> DUP @ CONTEXT @ SWAP CONTEXT ! OVER ! 2+ DUP @ CURRENT @ SWAP CURRENT ! SWAP ! ; VOCABULARY TARGET VOCABULARY TRANSITION VOCABULARY FORWARD VOCABULARY USER ONLY DEFINITIONS FORTH ALSO META ALSO </pre>	<pre> Start with the normal FORTH and ROOT vocabularies. Define META vocabulary which will contain all the words to effect metacompilation. Many of them are re-definitions. META vocabulary will be searched before FORTH vocabulary and ONLY vocabulary. Let META also be the current vocabulary so that new words will be added to META. An immediate version of FORTH. Declare [FORTH] as immediate so that it will be executed during compiling. An immediate version of META. Exchange the saved values of CONTEXT and CURRENT with themselves. It should always be used in pair to save and restore the CONTEXT and CURRENT vocabularies. Between the pair one can change vocabulary and select new vocabulary definitions. Two cells to save the current CONTEXT and CURRENT vocabularies. (--) Contents of the first cell of NOOP Context vocabulary. Copy save context to CONTEXT. Save CONTEXT to NOOP cell. Address of second NOOP cell. Fetch saved current vocabulary. Current CURRENT vocabulary. Save it in second NOOP cell. Restore CURRENT. A vocabulary to hold the symbol table for all definitions in the target system. A vocabulary holding special case compiling words like ." and [. A vocabulary holding all forward references as deferred words. A vocabulary holding the USER version of defining words. Add all the vocabulary names to the ONLY vocabulary so that they are always accessible and that all words in every vocabulary are accessible. Collect vocabulary names from both FORTH and META vocabularies. </pre>
-----------------------------------------------------------------------------------------------------------------------------------------------------------------------------------------------------------------------------------------------------------------------------------------------------------------------------------------------------------------------------------------------------	---------------------------------------------------------------------------------------------------------------------------------------------------------------------------------------------------------------------------------------------------------------------------------------------------------------------------------------------------------------------------------------------------------------------------------------------------------------------------------------------------------------------------------------------------------------------------------------------------------------------------------------------------------------------------------------------------------------------------------------------------------------------------------------------------------------------------------------------------------------------------------------------------------------------------------------------------------------------------------------------------------------------------------------------------------------------------------------------------------------------------------------------------------------------------------------------------------------------------------------------------------------------------------------------------------------------------------------------------------------------------------------------------------------------------------------------------------------------------------------------------------------------------------------------------------------------

```

: META META ;           META in ONLY calls META in FORTH.
: TARGET TARGET ;      And so forth.
: TRANSITION TRANSITION ;
: ASSEMBLER ASSEMBLER ;
: FORWARD FORWARD ;
: USER USER ;
ONLY FORTH ALSO META ALSO      Restore the search order as META, FORTH and ONLY.
DEFINITIONS

```

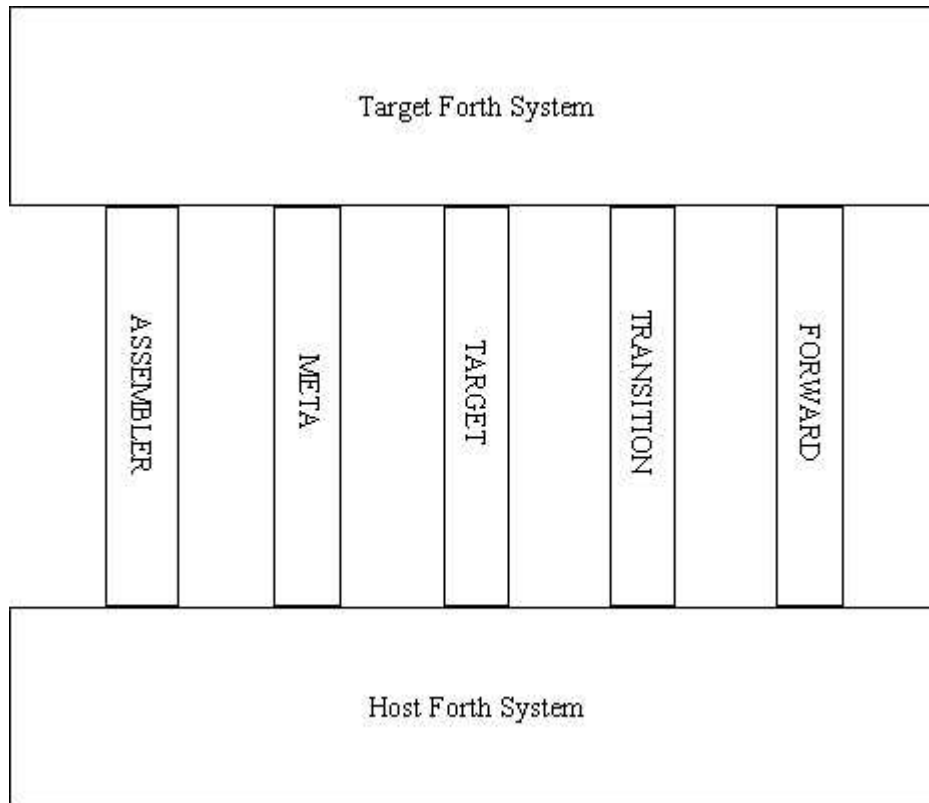

Figure 25.2 Supporting vocabularies for metacompilation

A few useful commands are defined to re-order the vocabularies in the searching sequence to locate specific commands in a specific vocabulary.

```

: IN-TARGET           Search only the symbol table.
ONLY TARGET DEFINITIONS
;
: IN-TRANSITION      Search TRANSITION, TARGET, and FORWARD in that order.
ONLY FORWARD ALSO
TARGET DEFINITIONS ALSO
TRANSITION
;
: IN-META            The normal environment in doing metacompilation.
ONLY FORTH ALSO
META DEFINITIONS ALSO
;
: IN-FORWARD        Used when a word is undefined and must be compiled on the fly.
FORWARD DEFINITIONS
;

```

25.3. Accessing Memory In The Target System

During metacompilation, the dictionary of the target system is in a virtual memory space to which new commands can be added but are not accessible for other purposes. These new commands can never be executed because the target system will only be useful in the target computer which may be a totally different machine from the host computer performing the metacompilation. The target virtual memory is mapped onto the host memory space by a constant offset and a variable dictionary pointer:

```
0 CONSTANT TARGET-ORIGIN      The offset address in the host memory where the target dictionary begins.
                                The value of TARGET-ORIGIN Must be assigned before metacompiling.
VARIABLE DP-T                 The dictionary pointer for the target system during metacompilation.
```

All memory accessing commands in Forth must be redefined for meta- compilation to access the memory of the target system.

```
: THERE ( taddr -- addr )      Map a target address to a host address.
  TARGET-ORIGIN +              Add offset.
;

: C@-T ( taddr -- char )      Fetch a byte from given target address.
  THERE C@                      ;

: @-T ( taddr -- n )          Fetch a word from given target address.
  THERE @                          ;

: C!-T ( char taddr -- )      Store a byte at the target address.
  THERE C!                          ;

: !-T ( n taddr -- )          Store a word at the target address.
  THERE !                          ;

: HERE-T ( -- taddr )          Return target address of the next available dictionary byte.
  DP-T @                          ;

: ALLOT-T ( n -- )            Allocate more space in the target dictionary.
  DP-T +!                          ;

: C,-T ( char -- )            Add a byte to the target dictionary.
  HERE-T C!-T                    Compile one byte.
  1 ALLOT-T                       Move target dictionary pointer.
;

: ,-T ( n -- )                Add a word to the target dictionary.
  HERE-T !-T                      Store one word.
  2 ALLOT-T                       Move pointer.
;

: S,-T ( addr n -- )          Add a string to the target dictionary.
  0 ?DO                          Scan the length of string.
    DUP C@                        Fetch one character.
    C,-T                          Compile one byte.
    1+                             Increment addr.
  LOOP
  DROP                             Discard addr still on stack.
;
```

25.4. Branching Constructs

Two sets of commands setting up and resolving branches are needed in the metacompiler: one for colon commands and one for code commands.

```

: ?>MARK ( -- f addr )      Set up a forward branch in colon definition.
TRUE                          Flag.
HERE-T                         Address for the forward branch.
0 ,-T                          Reserved for forward branch address.
;

: ?>RESOLVE ( f addr -- )    Resolve a forward branch.
HERE-T                         Address to branch to.
SWAP !                          Store at the from address.
?CONDITION                      Error checking.
;

: ?<MARK ( -- f addr )       Set up a backward branch.
TRUE                          Put the flag on the stack,
HERE-T                         with the current dictionary address.
;

: ?<RESOLVE ( f addr -- )    Resolve a backward branch.
,-T                             Store the address to be branched to.
?CONDITION                      Error checking.
;

```

The following branching commands are to be used in the assembler to set up branches in code commands.

```

: M?>MARK ( f addr -- )      Set up a forward branch in code definition.
TRUE                          Leave current address.
HERE-T                         Reserve one byte for branching offset.
0 C ,-T
;

: M?>RESOLVE ( f addr -- )    Resolve a forward branch in code definition.
HERE-T                         Current address.
OVER 1+ -                       Offset to the mark.
SWAP C!-T                       Store into the reserved space.
?CONDITION                      Error checking.
;

: M?<MARK ( -- f addr )       Set up a backward branch in code definition.
TRUE                          Push flag on the stack,
HERE-T                         with the dictionary address.
;

: M?<RESOLVE ( f -- addr )    Resolve a backward branch in code definition.
HERE-T 1+ -                       Offset from addr.
C ,-T                             Assemble offset after the branching instruction.
?CONDITION                      Error checking.
;

```

These assembler branching commands are to be used to build code commands in the target system. The regular Forth assembler can be used for target metacompilation if the branching commands are smart enough to assemble structures in the virtual memory space of the target system. They are made smart by patching the executing addresses of the above commands into the corresponding deferred commands in the regular assembler:

```

' C ,-T
  ASSEMBLER IS C,
' ,-T
  ASSEMBLER IS ,
' HERE-T ASSEMBLER IS HERE
' M?>MARK ASSEMBLER IS ?>MARK
' M?>RESOLVE ASSEMBLER IS ?>RESOLVE
' M?<MARK ASSEMBLER IS ?<MARK
' M?<RESOLVE ASSEMBLER IS ?<RESOLVE

```

All the tools provided in the assembler are now available for the metacompiler to build the nucleus portion of the target system.

25.5. Forward Reference

Forth normally does not allow forward referencing to commands that is not yet defined in its dictionary. This is a good practice to ensure that any defined command is immediately available for execution, testing and compiling. However, it presents a problem in metacompilation because we have to have defining commands to compile new commands into the target system, while these defining commands can only be defined much later in the metacompiling process. The defining commands must be made available at the very beginning of compiling the target system. F83 allows forward referencing to commands not yet defined by creating deferred commands which will be resolved and made executable at a later stage when the tools are available. The deferred commands will be linked together in a list stored in the FORWARD vocabulary. At the end of metacompilation, the list of forward references will be examined and vectored to executable commands.

```

: MAKE-CODE ( pfa -- )      Take the code field address pointed to by pfa and compile it in the target
                             system.
  @                          Fetch cfa from pfa.
  ,-T                        Compile to target dictionary.
;

: LINK-BACKWARDS ( pfa -- ) Extend the linked list of unresolved forward references.
  HERE-T                    Current dictionary address.
  OVER @ ,-T                Store the address pointed to by pfa into current dictionary.
  SWAP !                   Store current dictionary address into pfa, thus extending the linked list.
;

: RESOLVED? ( pfa -- f )   Return a true flag if the word whose pfa is on the stack is already resolve.
  2+                        Flag indicating that the word is resolved.
  C@                        Get it on stack as the flag.
;

: FORWARD-CODE ( pfa -- )  If a forward reference is resolved, compile the code. Otherwise link it
                             to the forward reference list.
  DUP RESOLVED?            A resolved forward reference?
  IF MAKE-CODE             If so, compile.
  ELSE LINK-FORWARD       Else link.
  THEN
;

: FORWARD: ( -- )         Define a forward reference word and initialize it to be unresolved.
  SWITCH                  Save the current vocabularies.
  FORWARD DEFINITIONS    Make FORWARD the current and context vocabulary to build the forward
                             reference word.
  CREATE                 Make the header.
  SWITCH                 Revert back to the original environment.
  0 ,                    Dummy execution address.
  0 C,                   Unresolved flag.
  DOES>                 ( -- )
  FORWARD-CODE          When a forward reference word is executed, either compile it to dictionary
                             or link to the list of unresolved references.
;

```

25.6. Compiling New Commands to Target System

VARIABLE WIDTH	The maximum length of the names in target definitions.
31 WIDTH !	It is initialized to allow 31 characters in names.
VARIABLE LAST-T	A variable pointing to the name field of the most recently defined word in target.
VARIABLE CONTEXT-T	Pointer to the array of context and resident vocabularies in the target.
VARIABLE CURRENT-T	Pointer to the vocabulary where new definitions are to be linked.
: HASH	(str-addr voc-addr -- thread) From the name of a definition and the address of the current vocabulary, return the thread address to link the new definition.
SWAP 1+ C@	Get the first character in the name.
3 AND	Only four threads are implemented.
2* +	Return the address of the thread in the body of the vocabulary.
;	
: HEADER (--)	Create a header in the target dictionary. It makes a header out of the next word in the input stream and fixes up all the appropriate pointers to link it into the target dictionary.
BL WORD	Get the name.
C@ 1+ WIDTH @ MIN	The length of the name field.
?DUP IF	If length is not zero, make the header.
ALIGN	Align new header to word boundary.
BLK @	Current block number.
4096 +	The view field with the block number and the file number, assumed to be 1.
, -T	Compile the view field.
HERE CURRENT-T @ HASH	Find the thread to link the new word.
DUP @-T , -T	Compile the link field.
HERE-T 2-	The link field address of the new word in the target dictionary.
SWAP !-T	Update the top of linking thread in the current vocabulary.
HERE-T	Save a copy of the name field address.
HERE ROT S, -T	Move the name from host to target.
ALIGN	Make sure the code field fall on even word boundary.
DUP LAST-T !	Update the LAST-T with new name field address.
128 SWAP THERE CSET	Set the delimiting bit in the first (count) byte of the name field.
128 HERE-T 1- THERE CST	Set the delimiting bit in the last byte of name field.
THEN	
;	No header will be created if WIDTH is set to zero.
: TARGET-CREATE (--)	Create a header in target and an entry in the symbol table. The new word is initialized as resolved so that it will be compiled to the target when invoked.
>IN @	Save the input stream pointer.
HEADER	Create the target header.
>IN !	Restore the input pointer to reuse the name of the new definition.
IN-TARGET CREATE	Create an entry in the symbol table, TARGET vocabulary.
IN-META	Return to metacompiler.
HERE-T ,	Compile the execution address of the new target word to pfa of the symbol table entry.
1 C,	Compile the resolved flag.
DOES>	(--) When the entry in the symbol table is executed, the execution address of the target word will be compiled to the target dictionary.
MAKE-CODE	Compile the contents of the pfa to target dictionary.
;	
: RECREATE (--)	Same as TARGET-CREATE, but don't advance the input stream pointer so that the name of word can be used again.
>IN @	Save the input stream pointer.
TARGET-CREATE	Create headers in target and symbol table.
>IN !	Restore input stream pointer.
;	
: CODE (--)	Set up to assemble a new code definition to the target dictionary. The target cfa is set to target pfa.
TARGET-CREATE	Make the headers.
HERE-T 2+	Parameter field address of the new code word.
, -T	Compile code field in the target code word.
ASSEMBLER !CSP	Set trap for error checking.
;	
: LABEL (--)	Remember the current target dictionary address and assign it a name so that a subroutine can be called from a code definition.

```

ASSEMBLER DEFINITIONS
HERE-T CONSTANT      Assign a name to the target address.
;

ASSEMBLER DEFINITIONS      Go back to the Forth assembler.

: END-CODE              Redefine the code word terminator for the target compiler.
IN-META                  Specify metacompiling environment.
?CSP                     Do error checking by comparing stack depth at the beginning and end of
                           a code definition.
;
META                      Return to metacompiler.
IN-META                  And reorder the vocabularies as needed by the metacompilation.

```

25.7. Transition Compiler Directives

Compiler directives, which build structures in the target commands or performing special actions other than compiling execution addresses, cannot be executed immediately within the target compilation environment. The compiler directives in the normal Forth cannot be used either, because structures and special conditions must be built in the target system. These metacompiler directives are all put in the TRANSITION vocabulary and are executed from there. When these compiler commands are encountered, `nwq` commands are compiled into the target dictionary. The corresponding commands in the TRANSITION vocabulary are executed so that the special condition in the target command can be dealt with immediately.

```

: 'T ( -- cfa )          Look up the next word in the input stream only in the target vocabulary.
                           Preserve original context.
CONTEXT @                Save context vocabulary.
TARGET DEFINED           Look up next word in the TARGET vocabulary. ( context cfa f -- )
ROT CONTEXT !           Restore context.
0= ?MISSING              Abort if the word cannot be found.
;

: [TARGET] ( -- )       Force the compilation of a TARGET word regardless of the current CONTEXT
                           vocabulary.
'T                        Find the word in TARGET vocabulary.
,                          Compile its execution address.
;

: 'F ( -- cfa )          Look up the next word in the input stream only in the FORWARD vocabulary.
                           Preserve current context.
CONTEXT @                Save context on stack.
FORWARD DEFINED          Search FORWARD vocabulary for the next input word.
ROT CONTEXT !           Restore context.
0= ?MISSING              Abort if word cannot be found in the FORWARD vocabulary.
;

: T: ( -- )              Define a new compiler directive word in the TRANSITION vocabulary. It
                           is otherwise the same as : .
SWITCH                   Save the current CONTEXT and CURRENT vocabularies.
TRANSITION DEFINITIONS  Make TRANSITION the current vocabulary.
CREATE                   Define the following word in the TRANSITION vocabulary.
SWITCH                   Restore original context.
]                          Compile the body of the new word.
DOES>                    This is how the new word defined by T: should be executed:
>R                        Push the parameter address of the new word on the return stack. The list
                           of execution addresses compiled in the parameter field will be executed
                           in sequence. Similar to what NEST might have done.
;

: T; ( -- )              Terminate a word defined by T:.
SWITCH                   Save context.
TRANSITION DEFINITIONS  Change context to TRANSITION.
[COMPILE] ;              Compile end of word definition.
SWITCH                   Restore context.

```

; IMMEDIATE

Following are the string commands for inline comments and documentation:

```
T: ( ( -- )
  [COMPILE] (      Inherit ( from host to TRANSITION.
  T;
```

```
T: ( S ( -- )
  [COMPILE] ( S    Inherit (S from host.
  T;
```

```
T: \ ( -- )
  [COMPILE] \     Inherit \ from host.
  T;
```

Special commands are needed to compile string literals into the target dictionary:

```
: STRING,-T ( -- )      Scan the input stream for a " as the string delimiter and compile the string into
                        target dictionary.
ASCII " PARSE          Parse input text to ".
DUP C@ 1+              Length of string just parsed.
S,-T                  Move the string and compile into the target dictionary.
ALIGN                 Align to cell boundary.
;
```

```
FORWARD: <(".">        Runtime forward reference for the code compiled by "." .
```

```
T: "."
  [FORWARD] <(".">     Compile the runtime code <("."> and a string literal in the target dictionary.
  STRING,-T           Compile the forward reference.
                      Compile the string literal.
;
```

```
FORWARD: <(">         Runtime forward reference for the code compiled by " .
```

```
T: "
  [FORWARD] <(">     Compile the unknown runtime code <("> with a string literal.
  STRING,-T           Compile the forward reference word <(">.
                      Compile string literal from input stream.
;
```

```
FORWARD: <(ABORT">    Runtime forward reference for ABORT".
```

```
T: ABORT"
  [FORWARD] <(ABORT"> Compile the unknown runtime code for abort, followed by a string.
  STRING,-T           Compile the abort code.
                      With the string literal.
;
```

```
FORWARD: <(;USES)>    Forward reference for code routine compiled by ;USES.
FORTH VARIABLE STATE-T True if in the compiling state inside a colon definition. False if outside
                        or in the interpreting state.
```

```
T: ;USES ( -- )      Compile a code field whose runtime routine already exists. It is similar to ;CODE
                        otherwise.
  [FORWARD] <(;USES)> Compile the code field using the address of <(;USES)>.
  IN-META             Force the context of metacompiler.
  ASSEMBLER           Invoke assembler to start assembling code routine.
  !CSP                Install error checking.
  STATE-T OFF         Assembler words are interpreted, not compiled.
  T;
```

```
T: [COMPILE] ( -- )  Compile a TARGET word rather than execute its TRANSITION counterpart.
  'T                  Find the next word and return its execution address.
  EXECUTE             Execute the word in the symbol table vocabulary TARGET. The effect is to compile
                        the word into the target dictionary.
;
```

```
FORWARD: <(IS)>      Forward reference to the runtime routine of IS.
```

```
T: IS ( -- )
  [FORWARD] <(IS)>   Compile the unknown address of <(IS)>.
  T;
```

```

: IS ( cfa -- )      This is the version of IS in the metacompiler which actually patches the forward
                    reference.
'T                  Find the cfa of the next word to be patched.
>BODY @             The execution address pointing to execution routine.
>BODY !-T           Patch in with the cfa on stack. Thus resolve the forward reference.
;

T: ALIGN            Align the dictionary pointer to word boundary.
T;                 This is not needed in 8086, which is a true byte machine.

T: EVEN ( n -- n' ) Make the number n even.
T;                 Noop in 8086 or 8080.

```

25.8. Defining Words In Metacompiler

```

FORWARD: <VARIABLE> Forward reference for runtime routine of CREATE and VARIABLE.

: CREATE            Create a target word using the runtime routine for VARIABLE and a host word to
                    return the HERE address in target.
RECREATE           Create target word and an entry in the symbol table vocabulary TARGET The input
                    pointer is not advanced.
[FORWARD] <VARIABLE> Compile code field in target.
HERE-T CONSTANT   Define the pfa as a constant in the host.
;

: VARIABLE         Define a variable in the target.
CREATE            Use the above CREATE.
0 ,-T            initialize the parameter field.
;
FORWARD: <DEFER>   Forward reference for the runtime routine of DEFER.

: DEFER           Define a deferred word or an execution vector in the target.
TARGET-CREATE    Create a target word and a symbol table entry.
[FORWARD] <DEFER> Compile code field.
0 ,-T            Compile a dummy parameter to hold execution address.
;

: DIGIT? ( char -- f ) Return true if the character is a digit in current base.
BASE @ DIGIT     Convert the char using current BASE.
NIP              Only the flag is needed. Discard the result of conversion.
;

: PUNCT? ( char -- f ) Return true if the character is a valid punctuation character for numbers such
                    as leading - or decimal point.
ASCII . OVER = SWAP A period?
ASCII - OVER = SWAP Or a minus sign?
ASCII / OVER = SWAP Or a / ?
DROP OR OR       Return the flag.
;

: NUMERIC? ( addr len --
f )              Return true if the string is a valid number in the current base. At least one
                    valid digit should be present in the string.
DUP 1 =          Only one character?
IF               Yes.
DROP            Discard len .
C@ DIGIT?       Is it a valid digit?
EXIT           No other action needed.
THEN
1 -ROT          Initial flag.
0 ?DO          Scan the length of the string.
DUP C@         Get one character.
DUP DIGIT?     Is it a digit?
SWAP PUNCT?    Or a punctuation?
OR ROT AND     AND the test results to flag.
SWAP 1+        Increment addr.
LOOP
DROP           Discard addr.
;

```

25.9. User Variables

User variables are collected in a table called user area for multitasking context switching. All the variables pertinent to the independent operation of a task have to be preserved for each user or task when it relinquishes control of CPU to other tasks, so that when it regains the control of CPU the task can continue from where was left off. The managing of the user area requires redefining many dictionary accessing commands. These redefinitions are collected in a separated vocabulary USER. The target compiler must have its own versions of these commands to compile user variables in the target system.

```
FORTH VARIABLE #USER-T      A variable in FORTH to count the number of user variables defined in the
                             target system.
META ALSO                   Revert to metacompiler.
USER DEFINITIONS           Following words are added to the USER vocabulary.

: ALLOT ( n -- )           Allocate space in the user area.
  #USER-T +!               Add n to the user area counter.
;

FORWARD: <USER-VARIABLE>   Forward reference for the runtime routine of USER-VARIABLE.

: VARIABLE ( -- )         Create a user variable in the user area.
  SWITCH                  Save context.
  RECREATE                 Create headers in target and symbol table.
  [FORWARD] <USER-VARIABLE> Compile code field pointing to <USER-VARIABLE>.
  #USER-T @                Current user area pointer.
  DUP ,-T                  Compile the pointer in parameter field.
  2 ALLOT                  Move user area pointer.
  META DEFINITIONS        Change current vocabulary to META.
  CONSTANT                 Create a constant in META holding the user area pointer.
  SWITCH                   Restore context.
;

FORWARD: <USER-DEFER>      Forward reference for runtime routine of user deferred words.

: DEFER ( -- )            Create a user deferred word or a task local execution vector.
  SWITCH                  Save context.
  TARGET-CREATE            Create target and symbol table entries.
  [FORWARD] <USER-DEFER>   Compile code field pointing to <USER-DEFER>.
  SWITCH                  Restore context.
  #USER-T @ ,-T           Compile the user area pointer.
  2 ALLOT                  Move user area pointer.
;

ONLY FORTH ALSO META ALSO  Restore the metacompiling environment.
DEFINITIONS
```

25.10. Vocabulary

The defining command VOCABULARY creates new vocabularies when the target system is brought up and running. In the parameter field of the vocabulary command, four cells are used to store the addresses of the ends of four dictionary threads for the hashing algorithm. The last cell stores the VOC-LINK address, which points to the vocabulary defined immediately before the currently defined vocabulary. This way, all the vocabularies defined in the running system are linked together themselves. This vocabulary linkage is necessary when vocabularies have to be trimmed by FORGET.

```

FORTH VARIABLE VOC-LINK-T      A variable linking all defined vocabularies together.

FORWARD: <VOCABULARY>        The forward reference for the runtime routine of VOCABULARY.

: VOCABULARY ( -- )          Create a vocabulary in the target system.
  RECREATE                   Create headers.
  [FORWARD] <VOCABULARY>     Compile code field.
  HERE-T                     Save the parameter field address of the defined vocabulary.
  #THREADS 0 DO 0 ,-T LOOP   Initialize four threads in the vocabulary.
  HERE-T VOC-LINK-T @ ,-T    Store previous vocabulary pfa after the thread field.
  VOC-LINK-T !               Store pfa of this vocabulary into VOC-LINK-T and extend the vocabulary
                              linkage.
  CONSTANT                   Define a constant in the host.
  DOES>                       ( -- )
  @                           Fetch the starting address of the thread field in the vocabulary.
  CONTEXT-T !                Store it in the context variable to make it the context vocabulary.
;

: IMMEDIATE ( -- )          If heads are compiled in target, set the precedent or immediate bit in
                              the name field.
  WIDTH @ IF                 If heads are compiled,
  64                          Precedent bit.
  LAST-T @ THERE             Address of the name field.
  CTOGGLE                    Flip the precedent bit.
  THEN                        ;

```

25.11. Resolving Forward References

```

: FIND-UNRESOLVED ( -- cfa f ) Search for a word in the FORWARD vocabulary and return the status.
  'F                          Find the next word in the input stream in the FORWARD vocabulary.
  DUP >BODY                    Get the parameter field address.
  RESOLVED?                    Return the a true flag if the word is resolved.
;

: RESOLVE ( taddr cfa -- )    Run through the linked list of forward reference and resolve each of them
                              with the given address.
  >BODY                          The parameter field address from cfa.
  2DUP                            Store the 'resolved' flag in the third byte of the forward reference word
  TRUE OVER 2+ C!                in FORWARD.
  @                               Address of the last member in the linked list of unresolved reference.
  BEGIN                          Run down the list.
  DUP                            If address is not 0, go do the resolving.
  WHILE
    2DUP @-T                      Get the next unresolved reference.
    -ROT                          Replace the old one.
    SWAP !-T                      Resolve the old reference.
  REPEAT
  2DROP                            Clear stack.
;

: RESOLVES ( taddr -- )      The command used by user to resolve forward reference.
  FIND-RESOLVED                Search the next word in the FORWARD vocabulary and determine if it is
                              resolved.
  IF                             Yes. Resolved.
  >NAME .ID                      Print its name.
  ." Already resolved."          And a message.
  DROP                            No need of taddr.
  ELSE                            Not resolved.
  RESOLVE                        Then resolve the references.
  THEN
;

```

At the end of metacompilation, all the forward references must be resolved before the target system is saved. Otherwise, the target system will surely crash when it is executed. There is a long list

of reference to be resolved. Following is a short list of examples for illustration. You should consult the source listing for the complete list.

```
' (.) RESOLVES <(.)>
' (") RESOLVES <(">
' (;CODE) RESOLVES <(;CODE)>
' (;USES) RESOLVES <(;USES)>
[FORTH] ASSEMBLER DOCREATE META RESOLVES <VARIABLE>
[FORTH] ASSEMBLER DOUSER-DEFER META RESOLVES <USER-DEFER>
etc., etc.
```

Deferred commands and many system variables need also be initialized:

```
' (LOAD) IS LOAD
' CRLF IS CR
' (KEY?) IS KEY?
etc., etc.

' FORTH >BODY CURRENT !-T
' FORTH >BODY CONTEXT !-T
HERE-T DP UP @-T + !-T
etc., etc.
```

25.12. Redefining Host Commands

Many important commands in the host or Forth vocabulary are redefined to be used in metacompilation. To use the host versions of them explicitly, they are redefined as host commands prefixed with an 'H' character before the regular name.

```
: H: [COMPILE] : ;
H: ' 'T >BODY @ ;
H: , , -T ;
H: C, C, -T ;
H: HERE HERE-T ;
H: ALLOT ALLOT-T ;
H: DEFINITIONS
  DEFINITIONS
  CONTEXT-T @ CURRENT-T !
;

: ]] ] ;           Alias of ], which will be used by the target compiler.
: [[ [COMPILE] [
;
FORTH IMMEDIATE META ]] has to be stopped by the FORTH [, which takes an alias of [[.
FORWARD: DEFINITIONS Making both [ and DEFINITIONS forward references so that the target compiler
can assign compiler functions to them.
FORWARD: [
```

25.13. Running The Metacompiler

Metacompilation is a complicated process and should be used only when you have to tailor the

Forth system to very specific application. Since F83 systems were generated using metacompilation and the authors were kind enough to provide us with the complete source of the metacompiler and the actual loading commands to generate the F83 system, we have an excellent guide and example to follow. It is worthwhile to review the loading sequence in generating the F83 system. When you do metacompiling of your own system, you probably should follow this sequence as close as possible, making minimal changes and modifications in the kernel and adding your applications on top of the kernel. After you have gone through this process several times and obtain working systems, then you can start re-work the kernel.

To fire up the metacompiler, you must first prepare a disk with F83.COM, META86.BLK, and KERNEL86.BLK files on it. Type

```
F83 META86.BLK
and 1 LOAD
```

to bring up the F83 system, which in turn will load the first screen in the META86.BLK, the load screen of the metacompiler. The loading command in screen 1:

```
3 21 THRU
```

loads the metacompiler, containing all the commands discussed in this chapter. After the metacompiler is loaded, we are ready to generate the kernel Forth or the minimal Forth operating system. The following command in screen 1 of META86.BLK open the KERNEL86.BLK file and compile the kernel Forth:

```
ONLY FORTH DEFINITIONS ALSO
FROM KERNEL86.BLK 1 LOAD
```

Since it will need the KERNEL86.BLK file, this file must also be on the disk. If your disk is not big enough to hold all these files, you should delete the FROM ... line from the screen 1 in META86.BLK. After the metacompiler is loaded, you can change disk and type it in on the keyboard to load the kernel.

Screen 1 of the KERNEL86.BLK file is the loading screen of the kernel. The commands:

```
ONLY FORTH META ALSO FORTH
```

include the META vocabulary in the search order and we are ready to compile the kernel.

However, we have to first allocate memory space to store the target kernel Forth system. This is done by:

```
256 DP-T !           Initialize the dictionary pointer and leave 256 bytes at the bottom of the
                    dictionary for interrupt vectors.
HERE 12000 +         The physical address of the target dictionary.
' TARGET-ORIGIN >BODY ! Store it in the constant, the address offset into the target dictionary.
IN-META             Establish the metacompiling environment.
2 92 THRU          Load the entire kernel FORTH system.
```

We should pay special attention to the last screens in the KERNEL86.BLK file, where all the forward references are resolved, all the deferred commands are vectored to proper executable commands, and all the system variables are initialized. To make a target system run properly, these things have to be done correctly.

After the kernel Forth is metacompiled, it must be saved on the disk as an executable object file. It is saved and given the name `KERNEL.COM`:

<code>META 256 THERE</code>	The physical address where the target dictionary starts.
<code>HERE-T</code>	The logical address of the end of the target dictionary, which is the length of the target dictionary in bytes.
<code>ONLY FORTH ALSO DOS</code>	Switch to DOS vocabulary to access the <code>SAVE</code> command.
<code>SAVE A:KERNEL.COM</code>	Copy the target dictionary into <code>KERNEL.COM</code> , which is executable.
<code>FORTH</code>	

At this point, we have generated a minimal Forth system and put it in an object file `KERNEL.COM`. This is a usable Forth system containing the text interpreter and colon compiler. However, its function is limited and not quite usable as a system to do programming and development work. If you wanted to develop a Forth application, this kernel serves well as the foundation to support your application. You can load the application program on top of the kernel and it will become a product you can sell. As a product, F83 system has lots of bells and whistles to add to the kernel. The sequence to add applications to the kernel Forth is as following.

```
BYE      Exit F83 and return to the DOS environment.
```

Copy the `KERNEL.COM` file to a disk which contains a file with all the application programs. In this file, screen 1 must be a load screen which will load all the application programs. In the case of F83 system, this file is `EXTEND86.BLK`. Moreover, `EXTEND86.BLK` will load programs in `UTILITY.BLK` and `CPU8086.BLK`. Therefore, you will have to copy these two files to the disk. If your disk does not have enough room for all these files, you can delete the loading commands in screen 1 of the `EXTEND86.BLK` file and type them on the keyboard after switching disks.

To load the application on top of the kernel, type:

```
    KERNEL EXTEND86.BLK
and 1 LOAD
```

The object file `KERNEL` will be loaded into the memory and the kernel Forth will be booted. It then loads the first screen in `EXTEND86.BLK` which loads in all the utility making up the entire F83 system. In this screen you will find the following loading commands:

<code>3 LOAD</code>	Load basic utility words and the <code>ONLY-ALSO</code> vocabulary mechanism.
<code>6 LOAD</code>	Load DOS file management words.
<code>FROM CPU8086.BLK 1 LOAD</code>	Load the 8086 assembler, and some CPU specific words to support I/O, debugger, and multitasker.
<code>FROM UTILITY.BLK 1 LOAD</code>	Load all the utility we discussed in Part III.

The F83 system is now complete and it is also saved on the disk in a file named `F83.COM`

```
SAVE A:F83.COM
```

This process is what was needed to build the F83 system. You have to follow it closely in building your own Forth system.

Index

' 103
!LINK 169
30,86
#BUFFERS 63
#REMAINING 124
#USER 167
(!FCB) 116
(.) 86
(+LOOP) 49
(BLOCK) 70
(CONSOLE) 56
(DARK) 123
(EMIT) 57
(KEY?) 56
(LOOP) 49
(PAUSE) 168
(SOURCE) 89
(WHERE) 124
, -T 192
.(92
.ALL 132
.DEFER 154
.FILE 119
.INLINE 151
.OTHER 154
.SCR 142
.UNNEST 152
.WORD 151
;USES 197
?<RESOLVE 112,174,193
?CHAR 121
?DO 113
?LINE 140
?TEXT 125
[101,201
[FORTH] 190
]] 201
+THRU 26
<(;USES)> 197
<IP 163
<USER-VARIABLE> 199
>BUFFERS 63
>NEXT 31, 43
>UPDATE 69
12MI 182
1PUSH 32,43
2SCR 155
6MI 181
A 16,23
A?>MARK 186
ABSENT? 69
ALLOT 102,166,199
ASCII 106
AUTO 133
B/FCB 63
BACKGROUND: 34,171
BDOS 56
BLOCK 70
BRING 128
BUG 10,163
C!-T 192
C; 174
CAPS-COMP 60
CHANGED 125,133
CLR-FCB 65
COLD 94
Compiler 98
CONVERT 84
COUNTER 34
CR-IN 58,58
'C#A 127
!-T 192
#) 30
#END 124
#S 86
#USE-T 199
(") 47,107
(?DO) 49
(ABORT") 109
(BLOT) 123
(CONVEY) 145
(DEBUG) 164
(FIND) 76
(LEAVE) 50
(NUMBER) 85
(PRINT) 57
(TILL) 120
, 102,174
,VIEW 136
.(;CODE) 152
.BRANCH 151
.DEFINITION-CLASS 155
.FINISH 152
.LINE 131
.PFA 153
.SCREEN 123
.USER-DEFER 153
/STRING 90
?.A 148
?>MARK 112,174,193
?CONDITION 112
?ERROR 108
?MISSING 103,126
@LINK 169
[[201
[META] 190
+LOAD 26
<# 85
<(ABORT")> 197
<MARK 112
<VARIABLE> 198
>END 63
>RESOLVE 112
>VIEW 136
13MI 182
2MI 180
3MI 180
7MI 181
A: 120
A?>RESOLVE 186
ACTIVATE 171
ALLOT-T 192
ASSEMBLER 173
AVOC 173
B/L? 177
BACKSPACES 57
BEGIN 113,187
BLOT 24,123
BS-IN 58
BYE 35
C, 102,174
C@-T 192
CASE: 150
CHANGED? 132
CNT 163
COMP 60
CONTEXT 73
CONVEY 23,145,147
COUNTS 34
CURRENT 73
!FCB 116
" 108,197
#> 85
#OUT 167
#THREAD 78
#VOC 73
((SEE)) 155
(?ERROR) 109
(ABORT) 94
(BUFFER) 70
(COPY) 144
(DEL-IN) 58
(I) 127
(LIT) 47
(NUMBER?) 84
(SEE) 151
(U.) 86
, " 108
. 86
.: 154
.BUFS 126
.DOES> 154
.FRAMED 126
.LINE0 142
.QUOTE 151
.STRING 151
.USER-VARIABLE 154
: 99
?.N 148
?>RESOLVE 112,174,195
?CR 140
?FAR 189
?STACK 96
@-T 192
['] 106
[TARGET] 196
+LOOP 113
<("> 197
<(IS)> 197
<RESOLVE 112
<VOCABULARY> 200
>IN 88
>SIZE 63
10MI 181
14MI 183
2PR 158
4MI 180
8MI 182
A?<MARK 186
ABORT 94
AGAIN 113,187
ALSO 12
ASSOCIATIVE: 150
B 23
B/REC 63
BACK-UP 58
BIG? 176
BOOT 94
BUFFER 70
BYTE 176
C,-T 192
CAPACITY 16,65
CC 59
CHAR 59
CODE 30,52,173,195
COMPARE 60,122
CONTEXT-T 195
CONVEY-COPY 144
CREATE 167,198
CURRENT-T 195
!FILES 119
"CREATE 74
#AFTER 124
#PAGE 157
#TIB 88
(92
(.) 47,107
(?LEAVE) 47
(AT) 123
(CHAR) 58
(D.) 87
(DO) 49
(KEY) 56
(LOAD) 120
(PAGE) 157
(SEMIT) 157
(UD.) 86
,/C, 177
." 108,197
.2 147
.CONSTANT 153
.EXECUTION-CLASS 152
.IMMEDIATE 153
.NAME 118
.R 86
.TO 145
.VARIABLE 154
; 100
?<MARK 112,174,193
?BRANCH 48
?DEFINE 119
?LEAVE 113
?STAMP 133
@VIEW 138
[COMPILE] 103,197
] 100
+T 127
<("> 197
<DEFER> 198
<USER-DEFER> 199
--> 26
>MARK 112
>TYPE 92
11MI 182
1MI 180
2PUSH 32,43
5MI 180
9MI 182
A?<RESOLVE 186
ABORT" 109
ALIGN 198
APUSH 43
AT 23,123
B/BUF 63
B: 120
BASE 82
BLK 89
BRANCH 48
BUFFER# 63
C 19,124
C/PAD 125
CAPS 121
CC-FORTH 59
CLOSE 115
COL# 124
COMPILE 102
CONTROL 106
COPY 23,144,146
CREATE-FILE 22,118
CURSOR 124

'CURSOR	124	D	23,129	D.	87	D.2	147
D.R	87	DARK	24	DARK	123	DEBNEXT	163
DEBUG	18	DEBUG	28	DEBUG	165	'DEBUG	163
Debugger	163	Decompiler	149	DEFAULT	117	DEFER	167
DEFER	199	DEFINE	120	DEFINED	78	DEFINITION-CLASS	155
DEFINITIONS	74	DEFINITIONS	201	DELETE	115	DELETE	122
DEL-IN	59	DIGIT	82	DIGIT?	198	DIR	118
DISCARD	69	DISK-ERROR	63	DL	26	DL	148
DLITERAL	103	DLN	148	DO	113	DO	187
DOCONSTANT	45	DOCREATE	44	DODEFER	46	DODOES	46
DOES?	151	DOES?	174	DOES-OP	174	DOES-SIZE	174
DONE	25	DONE	133	DONE?	96	DOS	10
DOS	115	DOS-ERR?	117	DOS-FCB	118	DOUBLE?	84
DOUSER-VARIABLE	45	DP	73	DPL	82	DP-T	192
DPUSH	43	DU	26	DU	148	DUMP	25
DUMP	147	DUMP	148	DX	131	DY	131
E	129	ED	24	ED	133	EDIT	24
EDIT	124	EDIT-AT	124	EDITING?	133	EDITOR	10
EDITOR	123	ELSE	113	ELSE	186	EMIT.	147
EMPTY-BUFFERS	72	END-CODE	30	END-CODE	52	END-CODE	174
END-CODE	196	ENTRY	166	EOS	125	EPSON	17
EPSON	157	ESC	184	ESC	193	ESTABLISH	144
EVEN	198	EXECUTE	43	EXECUTION-CLASS	152	EXIT	44
EXPECT	59	F	19,23,129	'F	196	'F+	127
F83	1,35	FAIL	82	FAR	178	FCB	65
FCB1	65,115	FCB2	115	FILE	70	FILE:	119
FILE?	119	FILE-IO	67	FILE-READ	66	FILE-SIZE	117
FILE-WRITE	66	FIND	78	'FIND	126	FIND?	128
FIND-UNRESOLVED	200	FIRST	63	FLUSH	23,72	FNEXT	164
FOOTING	157	FORM-FEED	157	FORWARD	190	FORWARD:	194
FORWARD-CODE	194	FOUND	123	FROM	22,120	G	128
GET-ID	132	H:	201	HASH	76,195	HEADER	118,195
HERE	102,174	HERE-T	192	HIDDEN	10	HLD	82
HOLD	85	HOP	22,145	HOPPED	145	I	23,50,127
IBM	134	IBM-AT	134	IBM-BLOT	134	IBM-DARK	134
IBM--LINE	134	ID	125	ID-LEN	125	IF	113,186
IMMEDIATE	102,200	IN-BLOCK	71	IND	143	INDEX	17,143
IN-FILE	70	IN-FORWARD	191	INITIAL	120	INIT-PR	17,157
IN-META	191	IN-RANGE	65	INSERT	122	'INSERT	125
INSTAL	133	INT	184	INT#	168	IN-TARGET	191
INTER	178	INTERPRET	95	IN-TRANSITION	191	IP	30
IP>	163	IS	19,198	J	23,50	JOIN	128
JUST	129	K	127	KEEP	127	KERNEL	35
KEY	57	KEY?	57	KT	129	L	17,23
L.ID	164	L/PAGE	157	LABEL	31,195	LARGEST	140
LAST-T	195	LATEST?	68	LEAVE	113	LENGTH	60
LIMIT	63	'LINE	124	-LINE	24,123	LINE#	124
LINK	167	LINK-BACKWARDS	194	LIST	13,23,142	LISTING	162
LITERAL	103	LMARGIN	140	LOAD	23,120	LOCAL	169
LOGO	157	Long string	61	LOOP	113	M	128
M?<MARK	193	M?<RESOLVE	193	M?>MARK	195	M?>RESOLVE	193
MAKE-CODE	194	MAKE-FILE	116	MAXREC#	65	MD	176
MEM,	177	META	190	MISSING	70	MODIFIED	125
Modularity	99	MORE	22,117	MOV	184	MOVE	60
MULTI	170	N	23	NEST	44	NEW	23,132
NEXT	31,43,187	NUMBER	85	NUMBER?	84	NUMERIC?	198
O	127	OFFSET	167	OK	120	ONLY	12
OP,	176	OPEN	16,120	OPEN-FILE	117	ORDER	13
OUT	149	P	23,127	PAGE	157	PARSE	91
PARSE-WORD	91	PAUSE	168	P-FOOTING	159	P-HEADING	159
P-IN	58	PLACE	90	PNEXT	164	PR	158
PR-FLUSH	160	PRINTING	167	PR-PAGE	160	PR-S-PAGE	160
PR-START	157	PR-STOP	158	PUNCT?	198	Q	19
QUERY	59	QUIT	94	R	129	R#	124
R/M	177	READ	116	READ-BLOCK	66	REC/BLK	63
RECORD#	65	REC-READ	66	RECREATE	195	REC-WRITE	66
REDISPLAY	131	REG	175	REG?	176	REGS	175
REPEAT	113,187	REPLACE	122	RES	164	RESET	115
RES-IN	58	RESOLVE	200	RESOLVED?	194	RESOLVES	200
RESTART	168	RESUME	165	RLOW	176	RMARGIN	140
R MID	176	ROOT	10	RP	30	RP0	167
RR,	177	RUN	95	S	129	S#)	30
S,-T	192	SAVE	118	SAVE-BUFFERS	23,71	SAVE-SYSTEM	34,118
SCAN	90	SCR#S	157	SEARCH	115,122	SEARCH0	115
SEE	14,155	SEG	184	SELECT	116	SET-DMA	65
SET-IO	66	SET-TASK	111	SHADOW	10,18	SHOW	18,161

SIGN 85	SINGLE 170	SIZE 176	SIZE, 177
SKIP 89	SLEEP 34,169	SLOW 164	SMART 134
SOURCE 89	SP 30	SP0 169	SPACE 57
SPACES 57	SPLIT 128	SPOOLER 34	SPOOL-THIS 34
STAMP 133	'START 124	STOP 170	STRING,-T 197
SWITCH 119,190	T 22,124	'T 196	T: 196
T; 196	TARGET 190	TARGET-CREATE 195	TARGET-ORIGIN 192
TASK: 171	TEST 185	TEXT? 158	THEN 113,186
THERE 192	THRU 26	TIB 59,88	'TIB 88
TILL 23,129	TO 145	TOP 124	TOS 169
TRACE 164	TRANSITION 190	TRIAD 142	TYPE 57
U 23, 128	U. 86	U.R 86	U/D 144
UD. 87	UD.R 87	UNBUG 164	UNNEST 44
'UNNEST 164	UNTIL 113,187	UP 45	UPC 60,121
UPDATE 23,69	UPPER 32,60	USER 10,167,190	VARIABLE 167,198,199
'VIDEO 126	VIEW 13,138	View field 136	VIEW# 65,136
VIEW> 137	VIEW-FILES 137	VIEWS 137	VOCABULARY 73,199
VOC-LINK 73	VOC-LINK-T 200	VOCS 10	W 30,127
W, 176	WAKE 34,169	WHERE 24,109	WHILE 113,187
WIDTH 195	WIPE 128	WMEM, 177	WORD 92
'WORD 92	WORDS 9,141	WR/SM 178	WRITE 116
WRITE-BLOCK 66	X 23,97,128	XCHG 184	